

C3225CH2J472K160AA

TDK Item Description : C3225CH2J472KT****



Application & Main Feature

Commercial Grade (Mid Voltage (100 to 630V))

Series

C3225 [EIA CC1210]

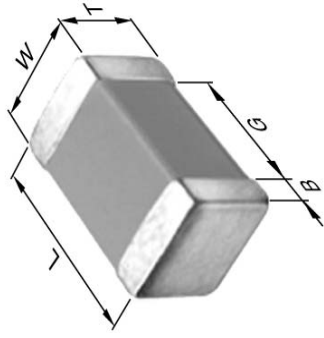

Dimensions

L	3.20mm	+/-0.4mm
W	2.50mm	+/-0.3mm
T	1.60mm	+/-0.2mm
B	0.20mm	Min.
G		

Temperature Characteristic

CH (-25 to 85 degC 0+/-60ppm/degC)

Rated Voltage

2J (630Vdc)

Capacitance

4.7nF

Capacitance Tolerance

K (+/-10%)

Q Factor

1000 Min.

Insulation Resistance

10Gohm Min.

AEC-Q200

Not Applicable

|Z|, ESR vs. Freq. Characteristics

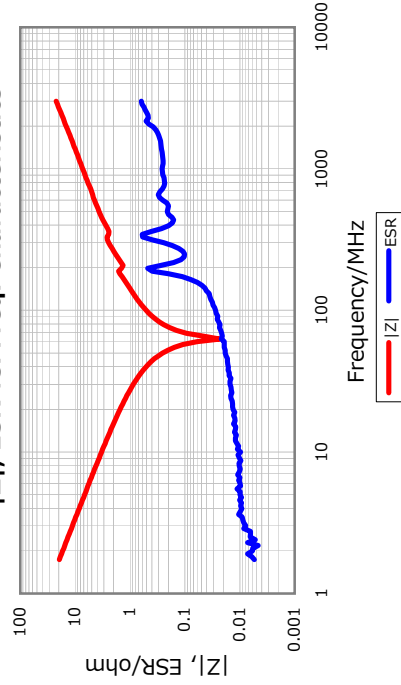

DC Bias Characteristic

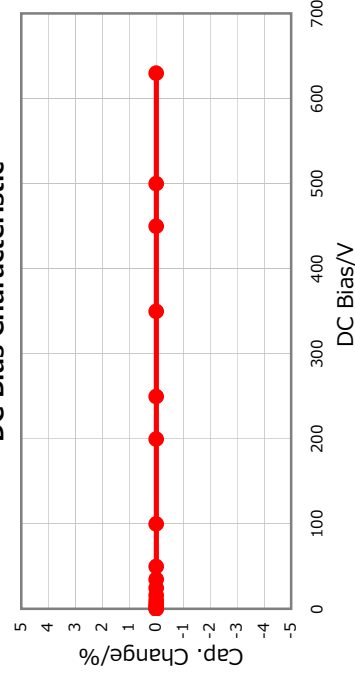

Cap. vs. Freq. Characteristic

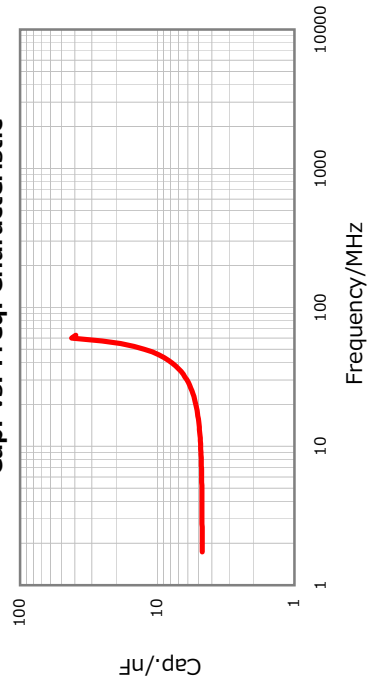

Temperature Characteristics

