

CGA3E2C0G1H680J080AD

TDK Item Description : CGA3E2C0G1H680JT***B

Equivalent C1608C0G1H680J for Automotive

Application & Main Feature

Automotive Grade (Conductive Epoxy Application)

Series

CGA3(1608) [EIA CC0603]

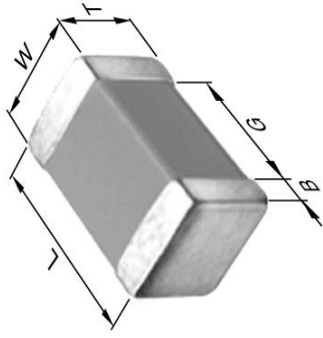

Dimensions

L	1.60mm	+/-0.15mm
W	0.80mm	+/-0.15mm
T	0.80mm	+/-0.15mm
B	0.20mm	Min.
G	0.30mm	Min.

Temperature Characteristic

C0G (-55 to 125 degC 0+/-30ppm/degC)

Rated Voltage

1H (50Vdc)

Capacitance

68pF

Capacitance Tolerance

J (+/-5%)

Q Factor

1000 Min.

Insulation Resistance

10Gohm Min.

AEC-Q200

Yes

|Z|, ESR vs. Freq. Characteristics

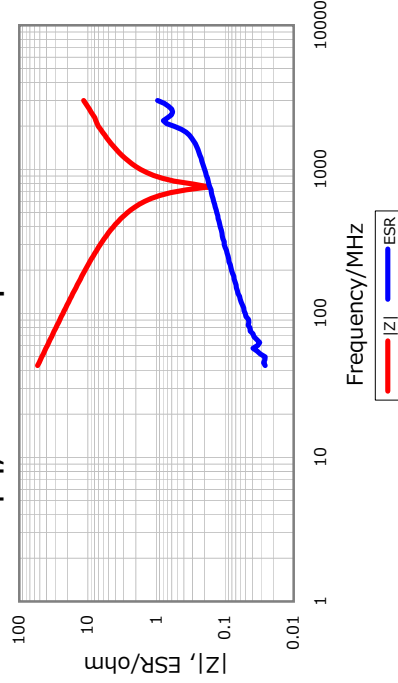

DC Bias Characteristic

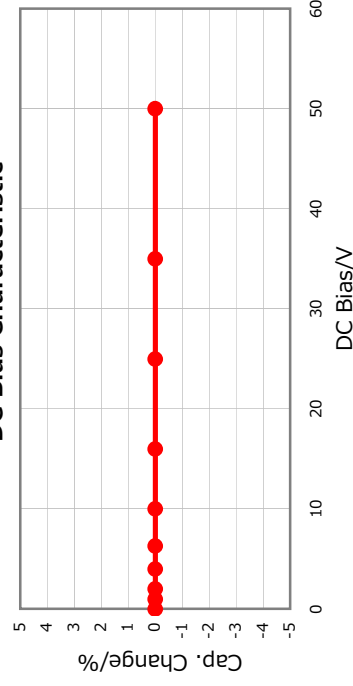

Cap. vs. Freq. Characteristic

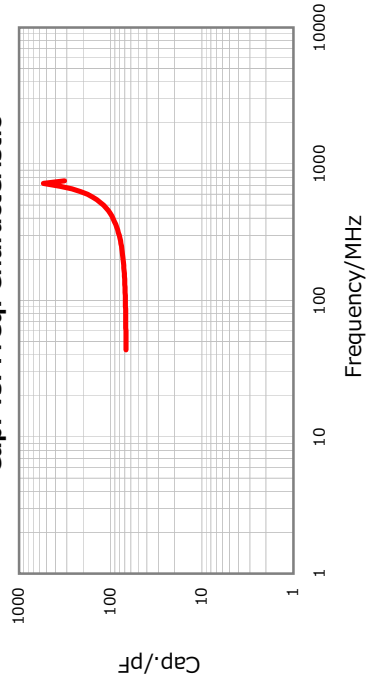

Temperature Characteristics

