

## CHIP COILS (CHIP INDUCTORS) LQP03HQ□□□□02□ REFERENCE SPECIFICATION

### 1. Scope

This reference specification applies to chip coils (chip inductors) LQP03HQ\_02 series for general electronic equipment.

### 2. Part Numbering

|            |           |                   |                                |          |            |           |             |                         |           |                       |
|------------|-----------|-------------------|--------------------------------|----------|------------|-----------|-------------|-------------------------|-----------|-----------------------|
| (Ex.)      | LQ        | P                 | 03                             | H        | Q          | 0N5       | W           | 0                       | 2         | D                     |
| Product ID | Structure | Dimension (L × W) | Application and characteristic | Category | Inductance | Tolerance | Performance | Electrode specification | Packaging | D: taping<br>*B: bulk |

\*B: Bulk packing is also available (taping condition: however, products without reels are put in plastic bags).

### 3. Part Number and Rating

|                             |                 |
|-----------------------------|-----------------|
| Operating temperature range | -55°C to +125°C |
| Storage temperature range   | -55°C to +125°C |

| Customer Part number | Murata Part number | Inductance         |             | Q (Min.) | DC resistance (Ω max.) | Self-resonant frequency (MHz) |                | Rated current (mA) |
|----------------------|--------------------|--------------------|-------------|----------|------------------------|-------------------------------|----------------|--------------------|
|                      |                    | Nominal value (nH) | Tolerance   |          |                        | Lower limit                   | *Typical value |                    |
|                      | LQP03HQ0N5W02D     | 0.5                | W: ±0.05 nH | 20       | 0.04                   | 20000                         | >20000         | 1100               |
|                      | LQP03HQ0N5B02D     | 0.5                | B: ±0.1 nH  | 20       | 0.04                   | 20000                         | >20000         | 1100               |
|                      | LQP03HQ0N5C02D     | 0.5                | C: ±0.2 nH  | 20       | 0.04                   | 20000                         | >20000         | 1100               |
|                      | LQP03HQ0N6W02D     | 0.6                | W: ±0.05 nH | 20       | 0.04                   | 20000                         | >20000         | 1100               |
|                      | LQP03HQ0N6B02D     | 0.6                | B: ±0.1 nH  | 20       | 0.04                   | 20000                         | >20000         | 1100               |
|                      | LQP03HQ0N6C02D     | 0.6                | C: ±0.2 nH  | 20       | 0.04                   | 20000                         | >20000         | 1100               |
|                      | LQP03HQ0N7W02D     | 0.7                | W: ±0.05 nH | 20       | 0.04                   | 20000                         | >20000         | 1100               |
|                      | LQP03HQ0N7B02D     | 0.7                | B: ±0.1 nH  | 20       | 0.04                   | 20000                         | >20000         | 1100               |
|                      | LQP03HQ0N7C02D     | 0.7                | C: ±0.2 nH  | 20       | 0.04                   | 20000                         | >20000         | 1100               |
|                      | LQP03HQ0N8W02D     | 0.8                | W: ±0.05 nH | 20       | 0.04                   | 18000                         | >20000         | 1100               |
|                      | LQP03HQ0N8B02D     | 0.8                | B: ±0.1 nH  | 20       | 0.04                   | 18000                         | >20000         | 1100               |
|                      | LQP03HQ0N8C02D     | 0.8                | C: ±0.2 nH  | 20       | 0.04                   | 18000                         | >20000         | 1100               |
|                      | LQP03HQ0N9W02D     | 0.9                | W: ±0.05 nH | 20       | 0.04                   | 18000                         | >20000         | 1100               |
|                      | LQP03HQ0N9B02D     | 0.9                | B: ±0.1 nH  | 20       | 0.04                   | 18000                         | >20000         | 1100               |
|                      | LQP03HQ0N9C02D     | 0.9                | C: ±0.2 nH  | 20       | 0.04                   | 18000                         | >20000         | 1100               |
|                      | LQP03HQ1N0W02D     | 1.0                | W: ±0.05 nH | 20       | 0.04                   | 16000                         | 20000          | 1100               |
|                      | LQP03HQ1N0B02D     | 1.0                | B: ±0.1 nH  | 20       | 0.04                   | 16000                         | 20000          | 1100               |
|                      | LQP03HQ1N0C02D     | 1.0                | C: ±0.2 nH  | 20       | 0.04                   | 16000                         | 20000          | 1100               |
|                      | LQP03HQ1N1W02D     | 1.1                | W: ±0.05 nH | 20       | 0.04                   | 14000                         | 18000          | 1100               |
|                      | LQP03HQ1N1B02D     | 1.1                | B: ±0.1 nH  | 20       | 0.04                   | 14000                         | 18000          | 1100               |
|                      | LQP03HQ1N1C02D     | 1.1                | C: ±0.2 nH  | 20       | 0.04                   | 14000                         | 18000          | 1100               |
|                      | LQP03HQ1N2W02D     | 1.2                | W: ±0.05 nH | 20       | 0.04                   | 13000                         | 17000          | 1100               |
|                      | LQP03HQ1N2B02D     | 1.2                | B: ±0.1 nH  | 20       | 0.04                   | 13000                         | 17000          | 1100               |
|                      | LQP03HQ1N2C02D     | 1.2                | C: ±0.2 nH  | 20       | 0.04                   | 13000                         | 17000          | 1100               |
|                      | LQP03HQ1N3W02D     | 1.3                | W: ±0.05 nH | 20       | 0.04                   | 13000                         | 20000          | 1100               |
|                      | LQP03HQ1N3B02D     | 1.3                | B: ±0.1 nH  | 20       | 0.04                   | 13000                         | 20000          | 1100               |
|                      | LQP03HQ1N3C02D     | 1.3                | C: ±0.2 nH  | 20       | 0.04                   | 13000                         | 20000          | 1100               |
|                      | LQP03HQ1N4W02D     | 1.4                | W: ±0.05 nH | 20       | 0.04                   | 12000                         | 20000          | 1100               |
|                      | LQP03HQ1N4B02D     | 1.4                | B: ±0.1 nH  | 20       | 0.04                   | 12000                         | 20000          | 1100               |

| Customer Part number | Murata Part number | Inductance         |                  | Q (Min.) | DC resistance ( $\Omega$ max.) | Self-resonant frequency (MHz) |                | Rated current (mA) |
|----------------------|--------------------|--------------------|------------------|----------|--------------------------------|-------------------------------|----------------|--------------------|
|                      |                    | Nominal value (nH) | Tolerance        |          |                                | Lower limit                   | *Typical value |                    |
|                      | LQP03HQ1N4C02D     | 1.4                | C: $\pm 0.2$ nH  | 20       | 0.04                           | 12000                         | 20000          | 1100               |
|                      | LQP03HQ1N5W02D     | 1.5                | W: $\pm 0.05$ nH | 20       | 0.05                           | 12000                         | 18500          | 1000               |
|                      | LQP03HQ1N5B02D     | 1.5                | B: $\pm 0.1$ nH  | 20       | 0.05                           | 12000                         | 18500          | 1000               |
|                      | LQP03HQ1N5C02D     | 1.5                | C: $\pm 0.2$ nH  | 20       | 0.05                           | 12000                         | 18500          | 1000               |
|                      | LQP03HQ1N6W02D     | 1.6                | W: $\pm 0.05$ nH | 20       | 0.05                           | 10000                         | 16000          | 1000               |
|                      | LQP03HQ1N6B02D     | 1.6                | B: $\pm 0.1$ nH  | 20       | 0.05                           | 10000                         | 16000          | 1000               |
|                      | LQP03HQ1N6C02D     | 1.6                | C: $\pm 0.2$ nH  | 20       | 0.05                           | 10000                         | 16000          | 1000               |
|                      | LQP03HQ1N7W02D     | 1.7                | W: $\pm 0.05$ nH | 20       | 0.07                           | 10000                         | 16000          | 800                |
|                      | LQP03HQ1N7B02D     | 1.7                | B: $\pm 0.1$ nH  | 20       | 0.07                           | 10000                         | 16000          | 800                |
|                      | LQP03HQ1N7C02D     | 1.7                | C: $\pm 0.2$ nH  | 20       | 0.07                           | 10000                         | 16000          | 800                |
|                      | LQP03HQ1N8W02D     | 1.8                | W: $\pm 0.05$ nH | 20       | 0.08                           | 10000                         | 16000          | 800                |
|                      | LQP03HQ1N8B02D     | 1.8                | B: $\pm 0.1$ nH  | 20       | 0.08                           | 10000                         | 16000          | 800                |
|                      | LQP03HQ1N8C02D     | 1.8                | C: $\pm 0.2$ nH  | 20       | 0.08                           | 10000                         | 16000          | 800                |
|                      | LQP03HQ1N9W02D     | 1.9                | W: $\pm 0.05$ nH | 20       | 0.12                           | 10000                         | 14700          | 600                |
|                      | LQP03HQ1N9B02D     | 1.9                | B: $\pm 0.1$ nH  | 20       | 0.12                           | 10000                         | 14700          | 600                |
|                      | LQP03HQ1N9C02D     | 1.9                | C: $\pm 0.2$ nH  | 20       | 0.12                           | 10000                         | 14700          | 600                |
|                      | LQP03HQ2N0W02D     | 2.0                | W: $\pm 0.05$ nH | 20       | 0.12                           | 9000                          | 15900          | 600                |
|                      | LQP03HQ2N0B02D     | 2.0                | B: $\pm 0.1$ nH  | 20       | 0.12                           | 9000                          | 15900          | 600                |
|                      | LQP03HQ2N0C02D     | 2.0                | C: $\pm 0.2$ nH  | 20       | 0.12                           | 9000                          | 15900          | 600                |
|                      | LQP03HQ2N1W02D     | 2.1                | W: $\pm 0.05$ nH | 20       | 0.12                           | 9000                          | 14300          | 600                |
|                      | LQP03HQ2N1B02D     | 2.1                | B: $\pm 0.1$ nH  | 20       | 0.12                           | 9000                          | 14300          | 600                |
|                      | LQP03HQ2N1C02D     | 2.1                | C: $\pm 0.2$ nH  | 20       | 0.12                           | 9000                          | 14300          | 600                |
|                      | LQP03HQ2N2W02D     | 2.2                | W: $\pm 0.05$ nH | 20       | 0.12                           | 9000                          | 14300          | 600                |
|                      | LQP03HQ2N2B02D     | 2.2                | B: $\pm 0.1$ nH  | 20       | 0.12                           | 9000                          | 14300          | 600                |
|                      | LQP03HQ2N2C02D     | 2.2                | C: $\pm 0.2$ nH  | 20       | 0.12                           | 9000                          | 14300          | 600                |
|                      | LQP03HQ2N3W02D     | 2.3                | W: $\pm 0.05$ nH | 20       | 0.12                           | 9000                          | 13800          | 600                |
|                      | LQP03HQ2N3B02D     | 2.3                | B: $\pm 0.1$ nH  | 20       | 0.12                           | 9000                          | 13800          | 600                |
|                      | LQP03HQ2N3C02D     | 2.3                | C: $\pm 0.2$ nH  | 20       | 0.12                           | 9000                          | 13800          | 600                |
|                      | LQP03HQ2N4W02D     | 2.4                | W: $\pm 0.05$ nH | 20       | 0.12                           | 9000                          | 13000          | 600                |
|                      | LQP03HQ2N4B02D     | 2.4                | B: $\pm 0.1$ nH  | 20       | 0.12                           | 9000                          | 13000          | 600                |
|                      | LQP03HQ2N4C02D     | 2.4                | C: $\pm 0.2$ nH  | 20       | 0.12                           | 9000                          | 13000          | 600                |
|                      | LQP03HQ2N5W02D     | 2.5                | W: $\pm 0.05$ nH | 20       | 0.12                           | 9000                          | 13000          | 600                |
|                      | LQP03HQ2N5B02D     | 2.5                | B: $\pm 0.1$ nH  | 20       | 0.12                           | 9000                          | 13000          | 600                |
|                      | LQP03HQ2N5C02D     | 2.5                | C: $\pm 0.2$ nH  | 20       | 0.12                           | 9000                          | 13000          | 600                |
|                      | LQP03HQ2N6B02D     | 2.6                | B: $\pm 0.1$ nH  | 20       | 0.12                           | 9000                          | 13000          | 600                |
|                      | LQP03HQ2N6C02D     | 2.6                | C: $\pm 0.2$ nH  | 20       | 0.12                           | 9000                          | 13000          | 600                |
|                      | LQP03HQ2N7B02D     | 2.7                | B: $\pm 0.1$ nH  | 20       | 0.12                           | 9000                          | 11600          | 600                |
|                      | LQP03HQ2N7C02D     | 2.7                | C: $\pm 0.2$ nH  | 20       | 0.12                           | 9000                          | 11600          | 600                |
|                      | LQP03HQ2N8B02D     | 2.8                | B: $\pm 0.1$ nH  | 20       | 0.12                           | 8000                          | 10500          | 600                |
|                      | LQP03HQ2N8C02D     | 2.8                | C: $\pm 0.2$ nH  | 20       | 0.12                           | 8000                          | 10500          | 600                |
|                      | LQP03HQ2N9B02D     | 2.9                | B: $\pm 0.1$ nH  | 20       | 0.12                           | 8000                          | 10500          | 600                |
|                      | LQP03HQ2N9C02D     | 2.9                | C: $\pm 0.2$ nH  | 20       | 0.12                           | 8000                          | 10500          | 600                |
|                      | LQP03HQ3N0B02D     | 3.0                | B: $\pm 0.1$ nH  | 20       | 0.12                           | 8000                          | 10500          | 600                |
|                      | LQP03HQ3N0C02D     | 3.0                | C: $\pm 0.2$ nH  | 20       | 0.12                           | 8000                          | 10500          | 600                |

| Customer Part number | Murata Part number | Inductance         |                 | Q (Min.) | DC resistance ( $\Omega$ max.) | Self-resonant frequency (MHz) |                | Rated current (mA) |
|----------------------|--------------------|--------------------|-----------------|----------|--------------------------------|-------------------------------|----------------|--------------------|
|                      |                    | Nominal value (nH) | Tolerance       |          |                                | Lower limit                   | *Typical value |                    |
|                      | LQP03HQ3N1B02D     | 3.1                | B: $\pm 0.1$ nH | 20       | 0.17                           | 7500                          | 10500          | 500                |
|                      | LQP03HQ3N1C02D     | 3.1                | C: $\pm 0.2$ nH | 20       | 0.17                           | 7500                          | 10500          | 500                |
|                      | LQP03HQ3N2B02D     | 3.2                | B: $\pm 0.1$ nH | 20       | 0.17                           | 7000                          | 10500          | 500                |
|                      | LQP03HQ3N2C02D     | 3.2                | C: $\pm 0.2$ nH | 20       | 0.17                           | 7000                          | 10500          | 500                |
|                      | LQP03HQ3N3B02D     | 3.3                | B: $\pm 0.1$ nH | 20       | 0.17                           | 7000                          | 10500          | 500                |
|                      | LQP03HQ3N3C02D     | 3.3                | C: $\pm 0.2$ nH | 20       | 0.17                           | 7000                          | 10500          | 500                |
|                      | LQP03HQ3N4B02D     | 3.4                | B: $\pm 0.1$ nH | 20       | 0.17                           | 7000                          | 9500           | 500                |
|                      | LQP03HQ3N4C02D     | 3.4                | C: $\pm 0.2$ nH | 20       | 0.17                           | 7000                          | 9500           | 500                |
|                      | LQP03HQ3N5B02D     | 3.5                | B: $\pm 0.1$ nH | 20       | 0.17                           | 7000                          | 9500           | 500                |
|                      | LQP03HQ3N5C02D     | 3.5                | C: $\pm 0.2$ nH | 20       | 0.17                           | 7000                          | 9500           | 500                |
|                      | LQP03HQ3N6B02D     | 3.6                | B: $\pm 0.1$ nH | 20       | 0.17                           | 7000                          | 9500           | 500                |
|                      | LQP03HQ3N6C02D     | 3.6                | C: $\pm 0.2$ nH | 20       | 0.17                           | 7000                          | 9500           | 500                |
|                      | LQP03HQ3N7B02D     | 3.7                | B: $\pm 0.1$ nH | 20       | 0.17                           | 7000                          | 9500           | 500                |
|                      | LQP03HQ3N7C02D     | 3.7                | C: $\pm 0.2$ nH | 20       | 0.17                           | 7000                          | 9500           | 500                |
|                      | LQP03HQ3N8B02D     | 3.8                | B: $\pm 0.1$ nH | 20       | 0.17                           | 7000                          | 9500           | 500                |
|                      | LQP03HQ3N8C02D     | 3.8                | C: $\pm 0.2$ nH | 20       | 0.17                           | 7000                          | 9500           | 500                |
|                      | LQP03HQ3N9B02D     | 3.9                | B: $\pm 0.1$ nH | 20       | 0.17                           | 7000                          | 9500           | 500                |
|                      | LQP03HQ3N9C02D     | 3.9                | C: $\pm 0.2$ nH | 20       | 0.17                           | 7000                          | 9500           | 500                |
|                      | LQP03HQ4N0B02D     | 4.0                | B: $\pm 0.1$ nH | 20       | 0.17                           | 7000                          | 9500           | 500                |
|                      | LQP03HQ4N0C02D     | 4.0                | C: $\pm 0.2$ nH | 20       | 0.17                           | 7000                          | 9500           | 500                |
|                      | LQP03HQ4N1B02D     | 4.1                | B: $\pm 0.1$ nH | 20       | 0.17                           | 7000                          | 9500           | 500                |
|                      | LQP03HQ4N1C02D     | 4.1                | C: $\pm 0.2$ nH | 20       | 0.17                           | 7000                          | 9500           | 500                |
|                      | LQP03HQ4N2B02D     | 4.2                | B: $\pm 0.1$ nH | 20       | 0.17                           | 7000                          | 9500           | 500                |
|                      | LQP03HQ4N2C02D     | 4.2                | C: $\pm 0.2$ nH | 20       | 0.17                           | 7000                          | 9500           | 500                |
|                      | LQP03HQ4N3H02D     | 4.3                | H: $\pm 3\%$    | 20       | 0.17                           | 7000                          | 9500           | 500                |
|                      | LQP03HQ4N3J02D     | 4.3                | J: $\pm 5\%$    | 20       | 0.17                           | 7000                          | 9500           | 500                |
|                      | LQP03HQ4N4H02D     | 4.4                | H: $\pm 3\%$    | 20       | 0.25                           | 7000                          | 9500           | 400                |
|                      | LQP03HQ4N4J02D     | 4.4                | J: $\pm 5\%$    | 20       | 0.25                           | 7000                          | 9500           | 400                |
|                      | LQP03HQ4N5H02D     | 4.5                | H: $\pm 3\%$    | 20       | 0.25                           | 7000                          | 9500           | 400                |
|                      | LQP03HQ4N5J02D     | 4.5                | J: $\pm 5\%$    | 20       | 0.25                           | 7000                          | 9500           | 400                |
|                      | LQP03HQ4N6H02D     | 4.6                | H: $\pm 3\%$    | 20       | 0.25                           | 7000                          | 9500           | 400                |
|                      | LQP03HQ4N6J02D     | 4.6                | J: $\pm 5\%$    | 20       | 0.25                           | 7000                          | 9500           | 400                |
|                      | LQP03HQ4N7H02D     | 4.7                | H: $\pm 3\%$    | 20       | 0.25                           | 7000                          | 9500           | 400                |
|                      | LQP03HQ4N7J02D     | 4.7                | J: $\pm 5\%$    | 20       | 0.25                           | 7000                          | 9500           | 400                |
|                      | LQP03HQ4N8H02D     | 4.8                | H: $\pm 3\%$    | 20       | 0.25                           | 5500                          | 7700           | 400                |
|                      | LQP03HQ4N8J02D     | 4.8                | J: $\pm 5\%$    | 20       | 0.25                           | 5500                          | 7700           | 400                |
|                      | LQP03HQ4N9H02D     | 4.9                | H: $\pm 3\%$    | 20       | 0.25                           | 5500                          | 7700           | 400                |
|                      | LQP03HQ4N9J02D     | 4.9                | J: $\pm 5\%$    | 20       | 0.25                           | 5500                          | 7700           | 400                |
|                      | LQP03HQ5N0H02D     | 5.0                | H: $\pm 3\%$    | 20       | 0.25                           | 5500                          | 7700           | 400                |
|                      | LQP03HQ5N0J02D     | 5.0                | J: $\pm 5\%$    | 20       | 0.25                           | 5500                          | 7700           | 400                |
|                      | LQP03HQ5N1H02D     | 5.1                | H: $\pm 3\%$    | 20       | 0.25                           | 5500                          | 7700           | 400                |
|                      | LQP03HQ5N1J02D     | 5.1                | J: $\pm 5\%$    | 20       | 0.25                           | 5500                          | 7700           | 400                |
|                      | LQP03HQ5N6H02D     | 5.6                | H: $\pm 3\%$    | 20       | 0.25                           | 5500                          | 7700           | 400                |
|                      | LQP03HQ5N6J02D     | 5.6                | J: $\pm 5\%$    | 20       | 0.25                           | 5500                          | 7700           | 400                |

| Customer Part number | Murata Part number | Inductance         |              | Q (Min.) | DC resistance ( $\Omega$ max.) | Self-resonant frequency (MHz) |                | Rated current (mA) |
|----------------------|--------------------|--------------------|--------------|----------|--------------------------------|-------------------------------|----------------|--------------------|
|                      |                    | Nominal value (nH) | Tolerance    |          |                                | Lower limit                   | *Typical value |                    |
|                      | LQP03HQ6N2H02D     | 6.2                | H: $\pm 3\%$ | 20       | 0.25                           | 5500                          | 7700           | 400                |
|                      | LQP03HQ6N2J02D     | 6.2                | J: $\pm 5\%$ | 20       | 0.25                           | 5500                          | 7700           | 400                |
|                      | LQP03HQ6N8H02D     | 6.8                | H: $\pm 3\%$ | 20       | 0.25                           | 5500                          | 7300           | 400                |
|                      | LQP03HQ6N8J02D     | 6.8                | J: $\pm 5\%$ | 20       | 0.25                           | 5500                          | 7300           | 400                |
|                      | LQP03HQ7N5H02D     | 7.5                | H: $\pm 3\%$ | 20       | 0.3                            | 4500                          | 6400           | 400                |
|                      | LQP03HQ7N5J02D     | 7.5                | J: $\pm 5\%$ | 20       | 0.3                            | 4500                          | 6400           | 400                |
|                      | LQP03HQ8N2H02D     | 8.2                | H: $\pm 3\%$ | 20       | 0.4                            | 4500                          | 6400           | 300                |
|                      | LQP03HQ8N2J02D     | 8.2                | J: $\pm 5\%$ | 20       | 0.4                            | 4500                          | 6400           | 300                |
|                      | LQP03HQ9N1H02D     | 9.1                | H: $\pm 3\%$ | 20       | 0.4                            | 4500                          | 6400           | 300                |
|                      | LQP03HQ9N1J02D     | 9.1                | J: $\pm 5\%$ | 20       | 0.4                            | 4500                          | 6400           | 300                |
|                      | LQP03HQ10NH02D     | 10                 | H: $\pm 3\%$ | 20       | 0.4                            | 4500                          | 5900           | 300                |
|                      | LQP03HQ10NJ02D     | 10                 | J: $\pm 5\%$ | 20       | 0.4                            | 4500                          | 5900           | 300                |
|                      | LQP03HQ11NH02D     | 11                 | H: $\pm 3\%$ | 20       | 0.5                            | 4000                          | 5200           | 300                |
|                      | LQP03HQ11NJ02D     | 11                 | J: $\pm 5\%$ | 20       | 0.5                            | 4000                          | 5200           | 300                |
|                      | LQP03HQ12NH02D     | 12                 | H: $\pm 3\%$ | 20       | 0.5                            | 4000                          | 5200           | 300                |
|                      | LQP03HQ12NJ02D     | 12                 | J: $\pm 5\%$ | 20       | 0.5                            | 4000                          | 5200           | 300                |
|                      | LQP03HQ13NH02D     | 13                 | H: $\pm 3\%$ | 20       | 0.5                            | 4000                          | 5100           | 300                |
|                      | LQP03HQ13NJ02D     | 13                 | J: $\pm 5\%$ | 20       | 0.5                            | 4000                          | 5100           | 300                |
|                      | LQP03HQ15NH02D     | 15                 | H: $\pm 3\%$ | 20       | 0.7                            | 3500                          | 4200           | 300                |
|                      | LQP03HQ15NJ02D     | 15                 | J: $\pm 5\%$ | 20       | 0.7                            | 3500                          | 4200           | 300                |
|                      | LQP03HQ16NH02D     | 16                 | H: $\pm 3\%$ | 20       | 0.8                            | 3500                          | 4200           | 250                |
|                      | LQP03HQ16NJ02D     | 16                 | J: $\pm 5\%$ | 20       | 0.8                            | 3500                          | 4200           | 250                |
|                      | LQP03HQ18NH02D     | 18                 | H: $\pm 3\%$ | 20       | 0.8                            | 3500                          | 4200           | 250                |
|                      | LQP03HQ18NJ02D     | 18                 | J: $\pm 5\%$ | 20       | 0.8                            | 3500                          | 4200           | 250                |
|                      | LQP03HQ20NH02D     | 20                 | H: $\pm 3\%$ | 20       | 0.8                            | 3000                          | 4200           | 250                |
|                      | LQP03HQ20NJ02D     | 20                 | J: $\pm 5\%$ | 20       | 0.8                            | 3000                          | 4200           | 250                |
|                      | LQP03HQ22NH02D     | 22                 | H: $\pm 3\%$ | 20       | 0.82                           | 3000                          | 3950           | 250                |
|                      | LQP03HQ22NJ02D     | 22                 | J: $\pm 5\%$ | 20       | 0.82                           | 3000                          | 3950           | 250                |
|                      | LQP03HQ24NH02D     | 24                 | H: $\pm 3\%$ | 15       | 1.6                            | 2000                          | 2900           | 170                |
|                      | LQP03HQ24NJ02D     | 24                 | J: $\pm 5\%$ | 15       | 1.6                            | 2000                          | 2900           | 170                |
|                      | LQP03HQ27NH02D     | 27                 | H: $\pm 3\%$ | 15       | 1.6                            | 2000                          | 2900           | 170                |
|                      | LQP03HQ27NJ02D     | 27                 | J: $\pm 5\%$ | 15       | 1.6                            | 2000                          | 2900           | 170                |
|                      | LQP03HQ30NH02D     | 30                 | H: $\pm 3\%$ | 12       | 2.0                            | 1700                          | 2700           | 150                |
|                      | LQP03HQ30NJ02D     | 30                 | J: $\pm 5\%$ | 12       | 2.0                            | 1700                          | 2700           | 150                |
|                      | LQP03HQ33NH02D     | 33                 | H: $\pm 3\%$ | 12       | 2.0                            | 1700                          | 2600           | 150                |
|                      | LQP03HQ33NJ02D     | 33                 | J: $\pm 5\%$ | 12       | 2.0                            | 1700                          | 2600           | 150                |
|                      | LQP03HQ36NH02D     | 36                 | H: $\pm 3\%$ | 12       | 2.0                            | 1500                          | 2400           | 150                |
|                      | LQP03HQ36NJ02D     | 36                 | J: $\pm 5\%$ | 12       | 2.0                            | 1500                          | 2400           | 150                |
|                      | LQP03HQ39NH02D     | 39                 | H: $\pm 3\%$ | 12       | 2.0                            | 1500                          | 2200           | 150                |
|                      | LQP03HQ39NJ02D     | 39                 | J: $\pm 5\%$ | 12       | 2.0                            | 1500                          | 2200           | 150                |
|                      | LQP03HQ43NH02D     | 43                 | H: $\pm 3\%$ | 12       | 2.5                            | 1300                          | 2200           | 130                |
|                      | LQP03HQ43NJ02D     | 43                 | J: $\pm 5\%$ | 12       | 2.5                            | 1300                          | 2200           | 130                |
|                      | LQP03HQ47NH02D     | 47                 | H: $\pm 3\%$ | 12       | 2.5                            | 1300                          | 2000           | 130                |
|                      | LQP03HQ47NJ02D     | 47                 | J: $\pm 5\%$ | 12       | 2.5                            | 1300                          | 2000           | 130                |

| Customer Part number | Murata Part number | Inductance         |              | Q (Min.) | DC resistance ( $\Omega$ max.) | Self-resonant frequency (MHz) |                | Rated current (mA) |
|----------------------|--------------------|--------------------|--------------|----------|--------------------------------|-------------------------------|----------------|--------------------|
|                      |                    | Nominal value (nH) | Tolerance    |          |                                | Lower limit                   | *Typical value |                    |
|                      | LQP03HQ51NH02D     | 51                 | H: $\pm 3\%$ | 12       | 2.5                            | 1200                          | 2000           | 130                |
|                      | LQP03HQ51NJ02D     | 51                 | J: $\pm 5\%$ | 12       | 2.5                            | 1200                          | 2000           | 130                |
|                      | LQP03HQ56NH02D     | 56                 | H: $\pm 3\%$ | 12       | 2.5                            | 1200                          | 2000           | 130                |
|                      | LQP03HQ56NJ02D     | 56                 | J: $\pm 5\%$ | 12       | 2.5                            | 1200                          | 2000           | 130                |
|                      | LQP03HQ62NH02D     | 62                 | H: $\pm 3\%$ | 12       | 5.0                            | 1100                          | 1800           | 100                |
|                      | LQP03HQ62NJ02D     | 62                 | J: $\pm 5\%$ | 12       | 5.0                            | 1100                          | 1800           | 100                |
|                      | LQP03HQ68NH02D     | 68                 | H: $\pm 3\%$ | 12       | 5.0                            | 1100                          | 1500           | 100                |
|                      | LQP03HQ68NJ02D     | 68                 | J: $\pm 5\%$ | 12       | 5.0                            | 1100                          | 1500           | 100                |
|                      | LQP03HQ75NH02D     | 75                 | H: $\pm 3\%$ | 10       | 5.0                            | 1100                          | 1400           | 100                |
|                      | LQP03HQ75NJ02D     | 75                 | J: $\pm 5\%$ | 10       | 5.0                            | 1100                          | 1400           | 100                |
|                      | LQP03HQ82NH02D     | 82                 | H: $\pm 3\%$ | 10       | 5.0                            | 1000                          | 1400           | 100                |
|                      | LQP03HQ82NJ02D     | 82                 | J: $\pm 5\%$ | 10       | 5.0                            | 1000                          | 1400           | 100                |
|                      | LQP03HQ91NH02D     | 91                 | H: $\pm 3\%$ | 10       | 7.0                            | 1000                          | 1300           | 80                 |
|                      | LQP03HQ91NJ02D     | 91                 | J: $\pm 5\%$ | 10       | 7.0                            | 1000                          | 1300           | 80                 |
|                      | LQP03HQR10H02D     | 100                | H: $\pm 3\%$ | 10       | 7.0                            | 900                           | 1300           | 80                 |
|                      | LQP03HQR10J02D     | 100                | J: $\pm 5\%$ | 10       | 7.0                            | 900                           | 1300           | 80                 |
|                      | LQP03HQR11H02D     | 110                | H: $\pm 3\%$ | 10       | 8.0                            | 900                           | 1100           | 80                 |
|                      | LQP03HQR11J02D     | 110                | J: $\pm 5\%$ | 10       | 8.0                            | 900                           | 1100           | 80                 |
|                      | LQP03HQR12H02D     | 120                | H: $\pm 3\%$ | 10       | 8.0                            | 800                           | 1100           | 80                 |
|                      | LQP03HQR12J02D     | 120                | J: $\pm 5\%$ | 10       | 8.0                            | 800                           | 1100           | 80                 |
|                      | LQP03HQR13H02D     | 130                | H: $\pm 3\%$ | 7        | 8.0                            | 700                           | 960            | 80                 |
|                      | LQP03HQR13J02D     | 130                | J: $\pm 5\%$ | 7        | 8.0                            | 700                           | 960            | 80                 |
|                      | LQP03HQR15H02D     | 150                | H: $\pm 3\%$ | 7        | 8.0                            | 700                           | 880            | 80                 |
|                      | LQP03HQR15J02D     | 150                | J: $\pm 5\%$ | 7        | 8.0                            | 700                           | 880            | 80                 |
|                      | LQP03HQR16H02D     | 160                | H: $\pm 3\%$ | 9        | 8.0                            | 700                           | 1100           | 80                 |
|                      | LQP03HQR16J02D     | 160                | J: $\pm 5\%$ | 9        | 8.0                            | 700                           | 1100           | 80                 |
|                      | LQP03HQR18H02D     | 180                | H: $\pm 3\%$ | 9        | 8.5                            | 700                           | 1000           | 80                 |
|                      | LQP03HQR18J02D     | 180                | J: $\pm 5\%$ | 9        | 8.5                            | 700                           | 1000           | 80                 |
|                      | LQP03HQR20H02D     | 200                | H: $\pm 3\%$ | 9        | 9.0                            | 700                           | 1000           | 75                 |
|                      | LQP03HQR20J02D     | 200                | J: $\pm 5\%$ | 9        | 9.0                            | 700                           | 1000           | 75                 |
|                      | LQP03HQR22H02D     | 220                | H: $\pm 3\%$ | 9        | 9.5                            | 650                           | 900            | 75                 |
|                      | LQP03HQR22J02D     | 220                | J: $\pm 5\%$ | 9        | 9.5                            | 650                           | 900            | 75                 |
|                      | LQP03HQR24H02D     | 240                | H: $\pm 3\%$ | 9        | 10.0                           | 650                           | 900            | 70                 |
|                      | LQP03HQR24J02D     | 240                | J: $\pm 5\%$ | 9        | 10.0                           | 650                           | 900            | 70                 |
|                      | LQP03HQR27H02D     | 270                | H: $\pm 3\%$ | 9        | 11.0                           | 650                           | 850            | 70                 |
|                      | LQP03HQR27J02D     | 270                | J: $\pm 5\%$ | 9        | 11.0                           | 650                           | 850            | 70                 |
|                      | LQP03HQR30H02D     | 300                | H: $\pm 3\%$ | 9        | 12.0                           | 600                           | 800            | 65                 |
|                      | LQP03HQR30J02D     | 300                | J: $\pm 5\%$ | 9        | 12.0                           | 600                           | 800            | 65                 |
|                      | LQP03HQR33H02D     | 330                | H: $\pm 3\%$ | 9        | 13.0                           | 550                           | 750            | 65                 |
|                      | LQP03HQR33J02D     | 330                | J: $\pm 5\%$ | 9        | 13.0                           | 550                           | 750            | 65                 |
|                      | LQP03HQR36H02D     | 360                | H: $\pm 3\%$ | 9        | 13.5                           | 500                           | 700            | 60                 |
|                      | LQP03HQR36J02D     | 360                | J: $\pm 5\%$ | 9        | 13.5                           | 500                           | 700            | 60                 |
|                      | LQP03HQR39H02D     | 390                | H: $\pm 3\%$ | 8        | 14.5                           | 500                           | 650            | 60                 |
|                      | LQP03HQR39J02D     | 390                | J: $\pm 5\%$ | 8        | 14.5                           | 500                           | 650            | 60                 |

| Customer Part number | Murata Part number | Inductance         |              | Q (Min.) | DC resistance ( $\Omega$ max.) | Self-resonant frequency (MHz) |                | Rated current (mA) |
|----------------------|--------------------|--------------------|--------------|----------|--------------------------------|-------------------------------|----------------|--------------------|
|                      |                    | Nominal value (nH) | Tolerance    |          |                                | Lower limit                   | *Typical value |                    |
|                      | LQP03HQR43H02D     | 430                | H: $\pm 3\%$ | 8        | 15.5                           | 500                           | 650            | 50                 |
|                      | LQP03HQR43J02D     | 430                | J: $\pm 5\%$ | 8        | 15.5                           | 500                           | 650            | 50                 |
|                      | LQP03HQR47H02D     | 470                | H: $\pm 3\%$ | 8        | 16.5                           | 450                           | 600            | 50                 |
|                      | LQP03HQR47J02D     | 470                | J: $\pm 5\%$ | 8        | 16.5                           | 450                           | 600            | 50                 |

\* Typical value is actual performance.

### 4. Testing Conditions

|                            |   |
|----------------------------|---|
| Unless otherwise specified | Temperature: ordinary temperature (15°C to 35°C)<br>Humidity: ordinary humidity [25% to 85% (RH)]   |
| In case of doubt           | Temperature: 20°C $\pm$ 2°C<br>Humidity: 60% to 70% (RH)<br>Atmospheric pressure: 86 kPa to 106 kPa |

### 5. Appearance and Dimensions

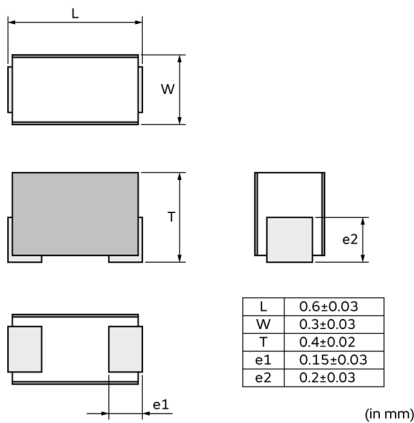

Unit mass (typical value): 0.22 mg

### 6. Marking

Side surface identification marking :blue

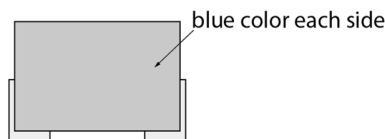

### 7. Electrical Performance

| No.     | Item             | Specification           | Test method   |         |                 |         |                 |         |                  |
|---------|------------------|-------------------------|---|---------|-----------------|---------|-----------------|---------|------------------|
| 7.1     | Inductance       | Meet chapter 3 ratings. | Measuring equipment: Keysight E4991A or the equivalent<br>Measuring frequency:<br><table border="1" style="margin-left: 20px;"> <tr> <td>500 MHz</td> <td>0.5 nH to 30 nH</td> </tr> <tr> <td>300 MHz</td> <td>33 nH to 120 nH</td> </tr> <tr> <td>100 MHz</td> <td>130 nH to 470 nH</td> </tr> </table> Measuring conditions:<br>Measurement signal level: Approx. 0 dBm<br>Electrical length: 10 mm<br>Weight: Approx. 1 N to 5 N | 500 MHz | 0.5 nH to 30 nH | 300 MHz | 33 nH to 120 nH | 100 MHz | 130 nH to 470 nH |
| 500 MHz | 0.5 nH to 30 nH  |                         |   |         |                 |         |                 |         |                  |
| 300 MHz | 33 nH to 120 nH  |                         |   |         |                 |         |                 |         |                  |
| 100 MHz | 130 nH to 470 nH |                         |   |         |                 |         |                 |         |                  |
| 7.2     | Q                | Meet chapter 3 ratings. |   |         |                 |         |                 |         |                  |

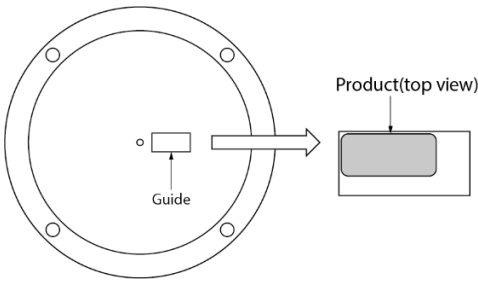
| No. | Item                    | Specification                       | Test method   |
|-----|-------------------------|-------------------------------------|---|
|     |                         |                                     | Measuring fixture: Keysight 16197A<br>Position the chip coil under test as shown in the measuring example below and connect it to the electrode by applying weight.<br>Measurement example:<br><br>Measuring method: see "Electrical performance: Measuring method for inductance/Q" in the Appendix. |
| 7.3 | DC resistance           | Meet chapter 3 ratings.             | Measuring equipment: digital multimeter   |
| 7.4 | Self-resonant frequency | Meet chapter 3 ratings.             | Measuring equipment: Keysight N5230A or the equivalent  |
| 7.5 | Rated current           | Product temperature rise: 25°C max. | Apply the rated current specified in chapter 3.   |

## 8. Mechanical Performance

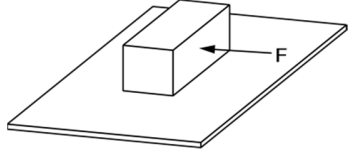
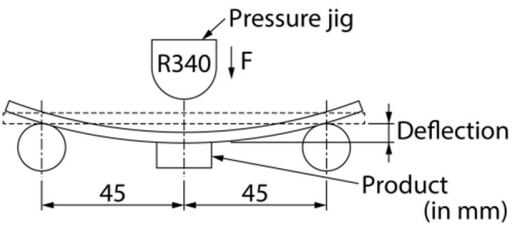
| No. | Item                         | Specification   | Test method   |
|-----|------------------------------|---|---|
| 8.1 | Shear test                   | No significant mechanical damage or no sign of electrode peeling off shall be observed.             | Test substrate: glass-epoxy substrate<br>Applying force: 2 N<br>Holding time: 5 s $\pm$ 1 s<br>Force application direction:<br>  |
| 8.2 | Bending test                 | No significant mechanical damage or no sign of electrode peeling off shall be observed.             | Test substrate: glass-epoxy substrate (100 mm $\times$ 40 mm $\times$ 0.8 mm)<br>Pressurizing speed: 1 mm/s<br>Pressure jig: R340<br>Deflection: 1 mm<br>Holding time: 30 s<br>                       |
| 8.3 | Vibration                    | Appearance shall have no significant mechanical damage.<br>Inductance change rate: within $\pm$ 10% | Oscillation frequency: 10 Hz to 2000 Hz to 10 Hz, for approx. 20 min<br>Total amplitude: total amplitude of 1.5 mm or acceleration amplitude of 196 m/s <sup>2</sup> , whichever is smaller<br>Test time: 3 directions perpendicular to each other, 2 h for each direction (6 h in total) |
| 8.4 | Solderability                | 90% or more of the outer electrode shall be covered with new solder seamlessly.                     | Flux: immersed in ethanol solution with a rosin content of 25(wt)% for 5 s to 10 s<br>Solder: Sn-3.0Ag-0.5Cu solder<br>Pre-heating: 150°C $\pm$ 10°C/60 s to 90 s<br>Solder temperature: 240°C $\pm$ 5°C<br>Immersion time: 3 s $\pm$ 1 s   |
| 8.5 | Resistance to soldering heat | Appearance: No significant mechanical damage shall be observed.                                     | Flux: immersed in ethanol solution with a rosin content of 25(wt)% for 5 s to 10 s  |

| No. | Item | Specification                             | Test method  |
|-----|------|---|--|
|     |      | Inductance change rate: within $\pm 10\%$ | Solder: Sn-3.0Ag-0.5Cu solder<br>Pre-heating: $150^{\circ}\text{C} \pm 10^{\circ}\text{C}/60\text{ s}$ to $90\text{ s}$<br>Solder temperature: $260^{\circ}\text{C} \pm 5^{\circ}\text{C}$<br>Immersion time: $5\text{ s} \pm 1\text{ s}$<br>Post-treatment: left at a room condition for $24\text{ h} \pm 2\text{ h}$ |

**9. Environmental Performance**

The product is soldered on a glass-epoxy substrate for test.

| No. | Item              | Specification  | Test method  |
|-----|-------------------|--|--|
| 9.1 | Heat resistance   | Appearance: No significant mechanical damage shall be observed.<br>Inductance change rate: within $\pm 10\%$ | Temperature: $125^{\circ}\text{C} \pm 2^{\circ}\text{C}$<br>Test time: $1000\text{ h}$ (+48 h, -0 h)<br>Post-treatment: left at a room condition for $24\text{ h} \pm 2\text{ h}$  |
| 9.2 | Cold resistance   | Appearance: No significant mechanical damage shall be observed.<br>Inductance change rate: within $\pm 10\%$ | Temperature: $-55^{\circ}\text{C} \pm 3^{\circ}\text{C}$<br>Test time: $1000\text{ h}$ (+48 h, -0 h)<br>Post-treatment: left at a room condition for $24\text{ h} \pm 2\text{ h}$  |
| 9.3 | Humidity          | Appearance: No significant mechanical damage shall be observed.<br>Inductance change rate: within $\pm 10\%$ | Temperature: $40^{\circ}\text{C} \pm 2^{\circ}\text{C}$<br>Humidity: $90\%$ (RH) to $95\%$ (RH)<br>Test time: $1000\text{ h}$ (+48 h, -0 h)<br>Post-treatment: left at a room condition for $24\text{ h} \pm 2\text{ h}$   |
| 9.4 | Temperature cycle | Appearance: No significant mechanical damage shall be observed.<br>Inductance change rate: within $\pm 10\%$ | Single cycle conditions:<br>Step 1: $-55^{\circ}\text{C} \pm 2^{\circ}\text{C}/30\text{ min} \pm 3\text{ min}$<br>Step 2: ordinary temperature/10 min to 15 min<br>Step 3: $+125^{\circ}\text{C} \pm 2^{\circ}\text{C}/30\text{ min} \pm 3\text{ min}$<br>Step 4: ordinary temperature/10 min to 15 min<br>Number of testing: 10 cycles<br>Post-treatment: left at a room condition for $24\text{ h} \pm 2\text{ h}$ |

**10. Specification of Packaging**

**10.1 Appearance and dimensions of tape (8 mm width/paper tape)**

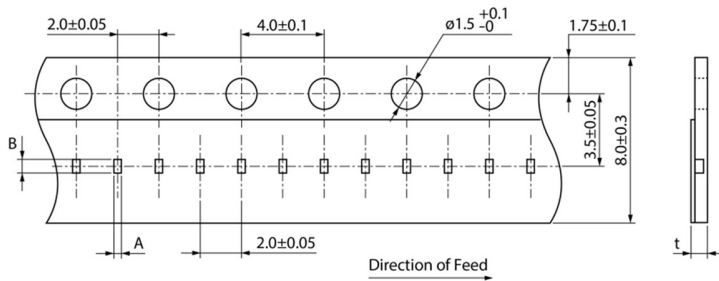

|   |           |
|---|-----------|
| A | (0.36)    |
| B | (0.68)    |
| t | 0.55 max. |

(in mm)

■ Top view

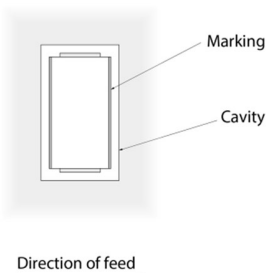



### 10.2 Taping specifications

|                                      |   |
|--------------------------------------|---|
| Packing quantity (Standard quantity) | 15000 pcs/reel  |
| Packing method                       | The products are placed in cavities of a carrier tape and sealed by a cover tape (top tape and bottom tape when the cavities of the carrier tape are punched type).       |
| Feed hole position                   | The feed holes on the carrier tape are on the right side when the cover tape (top tape when the cavities of the carrier tape are punched type) is pulled toward the user. |
| Joint                                | The carrier tape and cover tape (top tape when the cavities of the carrier tape are punched type) are seamless.   |
| Number of missing products           | Number of missing products within 0.1% of the number per reel or 1 pc., whichever is greater, and are not continuous. The specified quantity per reel is kept.            |

### 10.3 Break down force of tape

|   |          |
|---|----------|
| Cover tape (or top tape)  | 5 N min. |
| Bottom tape (only when the cavities of the carrier tape are punched type) | 5 N min. |

### 10.4 Peeling off force of tape

|                      |  |
|----------------------|--|
| Speed of peeling off | 300 mm/min   |
| Peeling off force    | 0.1 N to 0.6 N (The lower limit is for typical value.) |

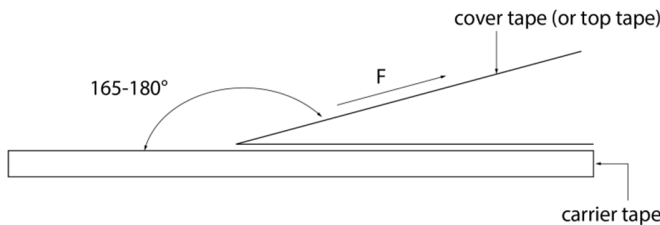

### 10.5 Dimensions of leader section, trailer section and reel

A vacant section is provided in the leader (start) section and trailer (end) section of the tape for the product. The leader section is further provided with an area consisting only of the cover tape (or top tape). (See the diagram below.)

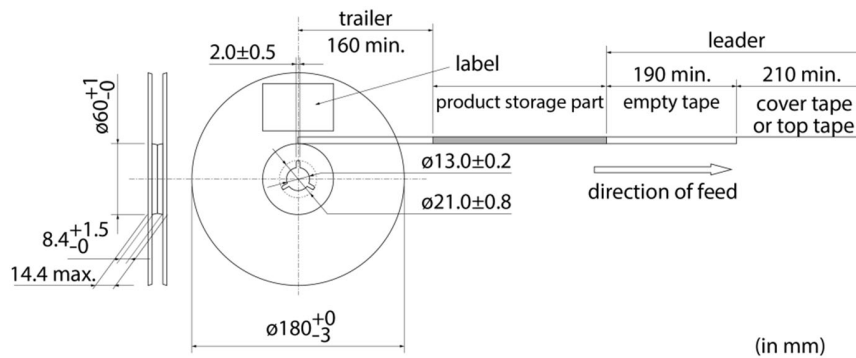

### 10.6 Marking for reel

Customer part number, Murata part number, inspection number (\*1), RoHS marking (\*2), quantity, etc.

|  |   |
|--|---|
| *1 Expression of inspection No.:<br>$\frac{\square\square}{(1)}$ $\frac{\circ\circ\circ\circ}{(2)}$ $\frac{\diamond\diamond\diamond}{(3)}$ | (1) Factory code<br>(2) Date<br>First digit: year/last digit of year<br>Second digit: month/Jan. to Sep. → 1 to 9, Oct. to Dec. → O, N, D<br>Third, Fourth digit: day<br>(3) Serial No. |
| *2 Expression of RoHS marking:<br>ROHS- $\frac{Y}{(1)}$ $\frac{(\Delta)}{(2)}$   | (1) RoHS regulation conformity<br>(2) Murata classification number  |

### 10.7 Marking on outer box (corrugated box)

Customer name, purchasing order number, customer part number, Murata part number, RoHS marking (\*2), quantity, etc.

## 10.8 Specification of outer box

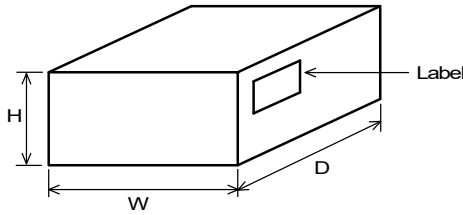

| Dimensions of outer box (mm)   |     |    | Standard reel quantity in outer box (reel) |
|--|-----|----|--|
| W  | D   | H  |  |
| 186  | 186 | 93 | 5  |
| * Above outer box size is typical. It depends on a quantity of an order. |     |    |  |

## 11. ⚠Caution

### 11.1 Restricted applications

Please contact us before using our products for the applications listed below which require especially high reliability for the prevention of defects which might directly cause damage to the third party's life, body or property.

- |                               |   |                              |   |
|-------------------------------|---|------------------------------|---|
| (1) Aircraft equipment        | (2) Aerospace equipment   | (3) Undersea equipment       | (4) Power plant control equipment       |
| (5) Medical equipment         | (6) Transportation equipment (vehicles, trains, ships, etc.)  | (7) Traffic signal equipment | (8) Disaster/crime prevention equipment |
| (9) Data-processing equipment | (10) Applications of similar complexity and/or reliability requirements to the applications listed in the above |                              |   |

### 11.2 Precautions on rating

Avoid using in exceeded the rated temperature range, rated voltage, or rated current. Usage when the ratings are exceeded could lead to wire breakage, burning, or other serious fault.

### 11.3 Inrush current

If an inrush current (or pulse current or rush current) that significantly exceeds the rated current is applied to the product, overheating could occur, resulting in wire breakage, burning, or other serious fault.

## 12. Precautions for Use

This product is for use only with reflow soldering. It is designed to be mounted by soldering. If you want to use other mounting method, for example, using a conductive adhesive, please consult us beforehand.

Also, if repeatedly subjected to temperature cycles or other thermal stress, due to the difference in the coefficient of thermal expansion with the mounting substrate, the solder (solder fillet part) in the mounting part may crack.

The occurrence of cracks due to thermal stress is affected by the size of the land where mounted, the solder volume, and the heat dissipation of the mounting substrate. Carefully design it when a large change in ambient temperature is assumed.

### 12.1. Land dimensions

The following diagram shows the recommended land dimensions for reflow soldering:

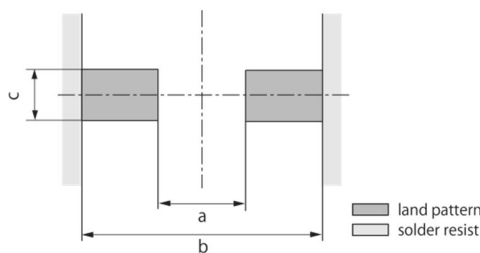

|   |              |
|---|--------------|
| a | 0.3          |
| b | 0.9          |
| c | 0.25 to 0.30 |

(in mm)

### 12.2 Flux and solder used

|        |  |
|--------|--|
| Flux   | <ul style="list-style-type: none"> <li>• Use a rosin-based flux.</li> <li>• Do not use a highly acidic flux with a halide content exceeding 0.2(wt)% (chlorine conversion value).</li> <li>• Do not use a water-soluble flux.</li> </ul> |
| Solder | <ul style="list-style-type: none"> <li>• Use Sn-3.0Ag-0.5Cu solder.</li> <li>• Standard thickness of solder paste: 100 μm</li> </ul>   |

### 12.3 Soldering conditions (reflow)

- Pre-heating should be in such a way that the temperature difference between solder and product surface is limited to 150°C max.  
Cooling into solvent after soldering also should be in such a way that the temperature difference is limited to 100°C max. Insufficient pre-heating may cause cracks on the product, resulting in the deterioration of product quality.
- Standard soldering profile and the limit soldering profile is as follows.  
The excessive limit soldering conditions may cause leaching of the electrode and/or resulting in the deterioration of product quality.

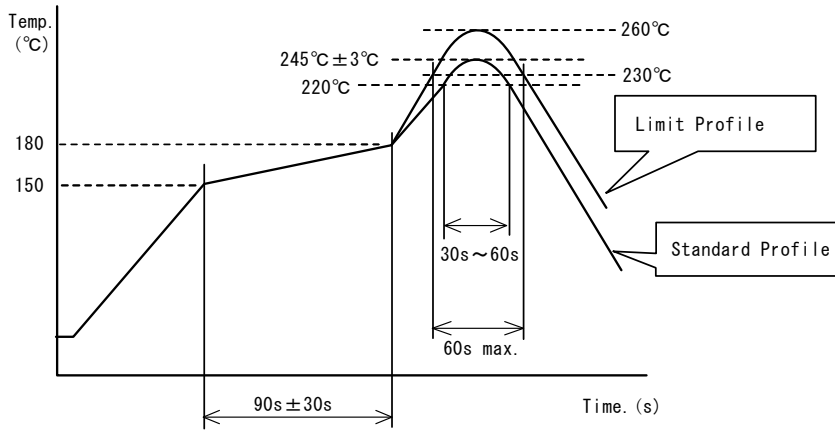

|                         | Standard profile         | Limit profile            |
|-------------------------|--------------------------|--------------------------|
| Pre-heating             | 150°C to 180°C/90 s±30 s | 150°C to 180°C/90 s±30 s |
| Heating                 | Above 220°C/30 s to 60 s | Above 230°C/60 s max.    |
| Peak temperature        | 245°C±3°C                | 260°C/10 s               |
| Number of reflow cycles | 2 times                  | 2 times                  |

### 12.4 Reworking with soldering iron

The following requirements must be met to rework a soldered product using a soldering iron.

| Item  | Requirement         |
|---|---------------------|
| Pre-heating   | 150°C/approx. 1 min |
| Tip temperature of soldering iron   | 350°C max.          |
| Power consumption of soldering iron   | 80 W max.           |
| Tip diameter of soldering iron  | ø3 mm max.          |
| Soldering time  | 3 s (+1 s, -0 s)    |
| Number of reworking operations  | 2 times max.        |
| * Avoid a direct contact of the tip of the soldering iron with the product. Such a direction contact may cause cracks in the ceramic body due to thermal shock. |                     |

### 12.5 Solder volume

Solder shall be used not to increase the volume too much.



$$\frac{1}{3} T \leq t \leq \frac{1}{2} T$$

T: thickness of product

An increased solder volume increases mechanical stress on the product. Exceeding solder volume may cause the failure of mechanical or electrical performance.

## 12.6 Product's location

The following shall be considered when designing and laying out PCBs.

(1) PCB shall be designed so that products are not subject to mechanical stress due to warping the board.

[Products direction]

Products shall be located in the sideways direction (length:  $a < b$ ) to the mechanical stress.

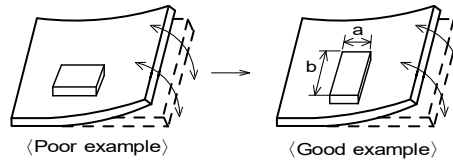

(2) Components location on PCB separation

It is effective to implement the following measures, to reduce stress in separating the board.

It is best to implement all of the following three measures; however, implement as many measures as possible to reduce stress.

| Contents of measures   | Stress level |
|--|--------------|
| (1) Turn the mounting direction of the component parallel to the board separation surface.   | $A > D^{*1}$ |
| (2) Add slits in the board separation part.  | $A > B$      |
| (3) Keep the mounting position of the component away from the board separation surface.  | $A > C$      |
| *1 $A > D$ is valid when stress is added vertically to the perforation as with hand separation. If a cutting disc is used, stress will be diagonal to the PCB, therefore $A > D$ is invalid. |              |

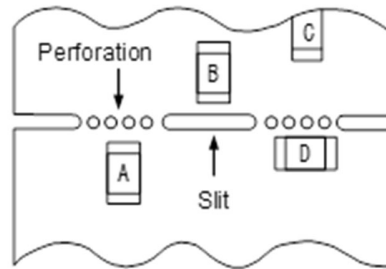

(3) Mounting components near screw holes

When a component is mounted near a screw hole, it may be affected by the board deflection that occurs during the tightening of the screw.

Mount the component in a position as far away from the screw holes as possible.

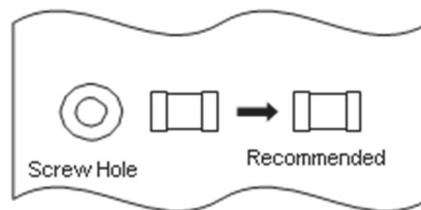

## 12.7 Handling of substrate

(1) The stress applied to the chip varies depending on the material and construction of the mounted substrate.

If the coefficients of thermal expansion for the substrate and chip vary significantly, the difference in thermal expansion and shrinkage could cause cracks to form in the chip.

We assume that the products are mounted on glass-epoxy substrate. Assessment has not been conducted on substrates where the coefficient of thermal expansion varies significantly from glass-epoxy substrates. If mounting on these substrates, be sure to conduct full assessments before use.

(2) After mounting products on a substrate, do not apply any stress to the product caused by bending or twisting to the substrate when cropping the substrate, inserting and removing a connector from the substrate or tightening screw to the substrate.

Excessive mechanical stress may cause cracking in the product.

Also, if mounting on flexible substrates, excessive mechanical stress could be applied to the chip by even slight bending or twisting when handling this substrate, and so please conduct full assessments before use.

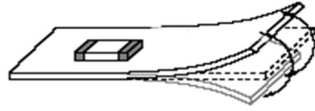

Bending

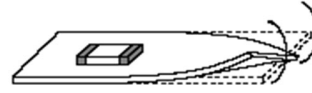

Twisting

## 12.8 Cleaning

The product shall be cleaned under the following conditions.

(1) The cleaning temperature shall be 60°C max. If isopropyl alcohol (IPA) is used, the cleaning temperature shall be 40°C max.

(2) Perform ultrasonic cleaning under the following conditions. Exercise caution to prevent resonance phenomenon in mounted products and the PCB.

| Item      | Requirement      |
|-----------|------------------|
| Power     | 20 W/L max.      |
| Time      | 5 min max.       |
| Frequency | 28 kHz to 40 kHz |

(3) Cleaner

Alcohol-based cleaner: IPA

Aqueous agent: PINE ALPHA ST-100S

(4) There shall be no residual flux or residual cleaner. When using aqueous agent, rinse the product with deionized water adequately and completely dry it so that no cleaner is left.

\* For other cleaning, consult our technical department.

## 12.9 Storage and transportation

|                    |  |
|--------------------|--|
| Storage period     | Use the product within 12 months after delivery.<br>If you do not use the product for more than 12 months, check solderability before using it.  |
| Storage conditions | <ul style="list-style-type: none"> <li>The products shall be stored in a room not subject to rapid changes in temperature and humidity. The recommended temperature range is -10°C to +40°C. The recommended relative humidity range is 15% to 85%. Keeping the product in corrosive gases, such as sulfur, chlorine gas or acid may cause the poor solderability.</li> <li>Do not place the products directly on the floor; they should be placed on a palette so that they are not affected by humidity or dust.</li> <li>Avoid keeping the products in a place exposed to direct sunlight, heat or vibration.</li> <li>Do not keep products in bulk packaging. Bulk storage could result in collisions between the products or between the products and other parts, resulting in chipping or wire breakage.</li> <li>Avoid storing the product by itself bare (i.e. exposed directly to air).</li> </ul> |
| Transportation     | Excessive vibration and impact reduces the reliability of the products. Exercise caution when handling the products.   |

## 12.10 Resin coating (including moisture-proof coating)

Before applying any resin coating, please consult our technical department.

## 12.11 Mounting conditions

Check the mounting condition before using.

Using mounting conditions (nozzles, equipment conditions, etc.) that are not suitable for products may lead to pick up errors, misalignment, or damage to the product.

## 12.12 Operating environment

Do not use this product under the following environmental conditions as it may cause deterioration of product quality.

(1) In the corrodible atmosphere such as acidic gases, alkaline gases, chlorine, sulfur gases, organic gases and etc. (the sea breeze, Cl<sub>2</sub>, H<sub>2</sub>S, NH<sub>3</sub>, SO<sub>2</sub>, NO<sub>2</sub>, etc)

(2) In the atmosphere where liquid such as organic solvent, may splash on the products.

(3) In the atmosphere where the temperature/humidity changes rapidly and it is easy to dew.

### 12.13 Mounting density

If this product is placed near heat-generating products, be sure to implement sufficient heat-dissipating measures.

If this product is subjected to a significant amount of heat from other products, this could adversely affect product quality, resulting in a circuit malfunction or failure of the mounted section. Also, be sure that the product is used in a manner so that the heat that the product is subjected to from other products does not exceed the upper limit of the rated operating temperature for the product.

### 13. Note

- (1) Please make sure that your product has been evaluated in view of your specifications with our product being mounted to your product.
- (2) You are requested not to use our product deviating from the reference specifications.
- (3) The contents of this reference specification are subject to change without advance notice. Please approve our product specifications or transact the approval sheet for product specifications before ordering.

## Appendix

Electrical performance: Measuring method for inductance/Q (Q measurement is applicable only when the Q value is included in the rating table.)

Perform measurement using the method described below. (Perform correction for the error deriving from the measuring terminal.)

(1) Residual elements and stray elements of the measuring terminal can be expressed by the F parameter for the 2-pole terminal as shown in the figure below.

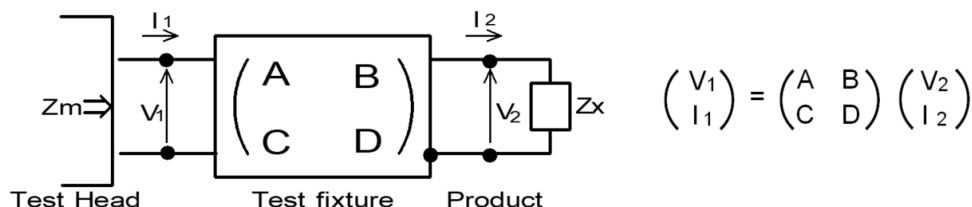

(2) The product's impedance value ( $Z_x$ ) and measured impedance value ( $Z_m$ ) can be expressed as shown below, by using the respective current and voltage for input/output.

$$Z_m = \frac{V_1}{I_1} \quad Z_x = \frac{V_2}{I_2}$$

(3) Thus, the relationship between the product's impedance value ( $Z_x$ ) and measured impedance value ( $Z_m$ ) is as follows.

|   |  |
|---|--|
| $Z_x = \alpha \frac{Z_m - \beta}{1 - Z_m \Gamma}$ | <p>Here,</p> <p><math>\alpha = D/A = 1</math></p> <p><math>\beta = B/D = Z_{sm} - (1 - Y_{om} Z_{sm}) Z_{ss}</math></p> <p><math>\Gamma = C/A = Y_{om}</math></p> <p><math>Z_{sm}</math>: measured impedance of short chip</p> <p><math>Z_{ss}</math>: residual impedance of short chip (0.480 nH)</p> <p><math>Y_{om}</math>: measured admittance when measuring terminal is open</p> |
|---|--|

(4) Calculate inductance  $L_x$  and  $Q_x$  using the equations shown below.

|   |  |
|---|--|
| $L_x = \frac{\text{Im}(Z_x)}{2\pi f}$         | <p><math>L_x</math>: inductance of chip coil</p>                                   |
| $Q_x = \frac{\text{Im}(Z_x)}{\text{Re}(Z_x)}$ | <p><math>Q_x</math>: Q of chip coil</p> <p><math>f</math>: measuring frequency</p> |