

LQW18AS27NG0Z#

“#” indicates a package specification code.

Designed under Industrial Global Standard



< List of part numbers with package codes >

LQW18AS27NG0ZB LQW18AS27NG0ZD LQW18AS27NG0ZJ

Appearance & Shape

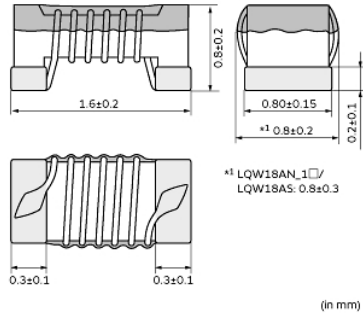

References

Packaging	Specifications	Standard Packing Quantity
B	Bulk(Bag)	500
D	180mm Paper Tape	4000
J	330mm Paper Tape	10000

Mass (typ.)	
1 piece	0.003g

Attention

- 1.This datasheet is downloaded from the website of Murata Manufacturing Co., Ltd. Therefore, it's specifications are subject to change or our products in it may be discontinued without advance notice. Please check with our sales representatives or product engineers before ordering.
- 2.This datasheet has only typical specifications because there is no space for detailed specifications. Therefore, please review our product specifications or consult the approval sheet for product specifications before ordering.

LQW18AS27NG0Z#

“#” indicates a package specification code.



Specifications

L size	1.6±0.2mm
W size	0.8±0.3mm
T size	0.8±0.2mm
Size code inch (mm)	0603 (1608)
Inductance	27nH±2%
Inductance Test Frequency	250MHz
Rated current (Itemp) (Based on Temperature rise)	600mA
Max. of DC resistance	0.22Ω
Operating Temperature Range (Self-temperature rise is included)	-40°C to 125°C
Q(min.)	40
Q Test Frequency	250MHz
Self resonance frequency (min.)	2800MHz
Brand	Murata
Series	LQW18AS_0Z

Attention

- 1.This datasheet is downloaded from the website of Murata Manufacturing Co., Ltd. Therefore, it's specifications are subject to change or our products in it may be discontinued without advance notice. Please check with our sales representatives or product engineers before ordering.
- 2.This datasheet has only typical specifications because there is no space for detailed specifications. Therefore, please review our product specifications or consult the approval sheet for product specifications before ordering.