

LQW31HN27NK03#

“#” indicates a package specification code.

Size Code 3216 (1206) in mm (in inch), Wound Type



< List of part numbers with package codes >

LQW31HN27NK03K LQW31HN27NK03L

Appearance & Shape

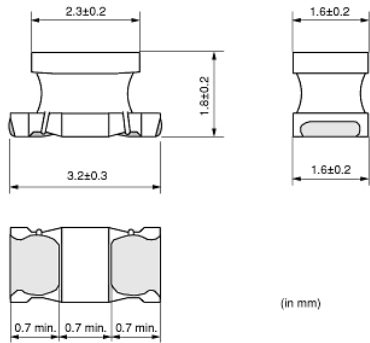
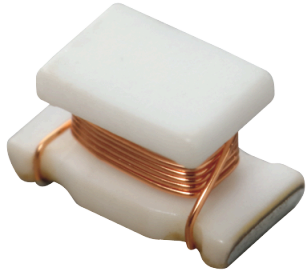

References

Packaging	Specifications	Standard Packing Quantity
K	330Embossed Tape	7500
L	180Embossed Tape	2000

Mass (typ.)	
1 piece	0.02g

Attention

- 1.This datasheet is downloaded from the website of Murata Manufacturing Co., Ltd. Therefore, it's specifications are subject to change or our products in it may be discontinued without advance notice. Please check with our sales representatives or product engineers before ordering.
- 2.This datasheet has only typical specifications because there is no space for detailed specifications. Therefore, please review our product specifications or consult the approval sheet for product specifications before ordering.

LQW31HN27NK03#

“#” indicates a package specification code.



Specifications

L size	3.2±0.3mm
W size	1.6±0.2mm
T size	1.8±0.2mm
Size code inch (mm)	1206 (3216)
Inductance	27nH±10%
Inductance Test Frequency	100MHz
Rated current (Itemp) (Based on Temperature rise)	560mA
Max. of DC resistance	0.0714Ω
Q(min.)	60
Q Test Frequency	436MHz
Self resonance frequency (min.)	1000MHz
Operating Temperature Range(Self-temperature rise is not included)	-40°C to 85°C
Brand	Murata
DC Resistance Intermediate Values	0.051Ω±40%
Series	LQW31HN_03

Attention

1.This datasheet is downloaded from the website of Murata Manufacturing Co., Ltd. Therefore, it's specifications are subject to change or our products in it may be discontinued without advance notice. Please check with our sales representatives or product engineers before ordering.

2.This datasheet has only typical specifications because there is no space for detailed specifications.

Therefore, please review our product specifications or consult the approval sheet for product specifications before ordering.

LQW31HN27NK03#

"#" indicates a package specification code.



Characteristic Data

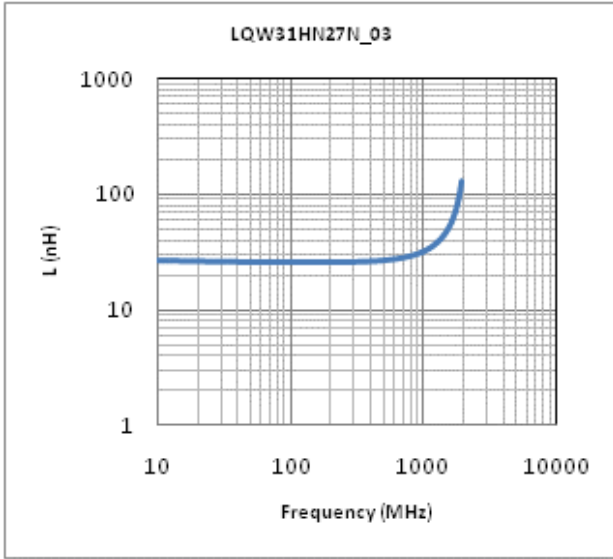

Inductance - Frequency Characteristics

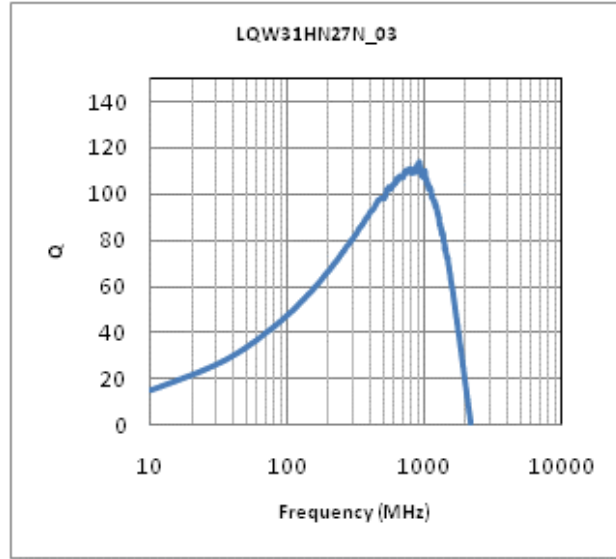

Q-Frequency Characteristics

Attention

- 1.This datasheet is downloaded from the website of Murata Manufacturing Co., Ltd. Therefore, it's specifications are subject to change or our products in it may be discontinued without advance notice. Please check with our sales representatives or product engineers before ordering.
- 2.This datasheet has only typical specifications because there is no space for detailed specifications. Therefore, please review our product specifications or consult the approval sheet for product specifications before ordering.