

LQW18AS51NG0Z#

“#” indicates a package specification code.

Designed under Industrial Global Standard



< List of part numbers with package codes >

LQW18AS51NG0ZB LQW18AS51NG0ZD LQW18AS51NG0ZJ

Appearance & Shape

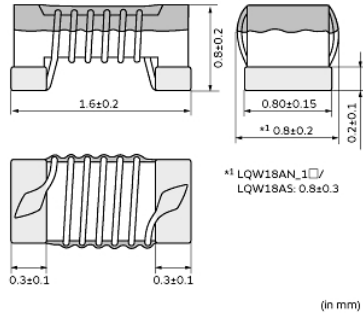
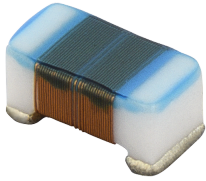

References

Packaging	Specifications	Standard Packing Quantity
B	Bulk(Bag)	500
D	180mm Paper Tape	4000
J	330mm Paper Tape	10000

Mass (typ.)	
1 piece	0.003g

Attention

- 1.This datasheet is downloaded from the website of Murata Manufacturing Co., Ltd. Therefore, it's specifications are subject to change or our products in it may be discontinued without advance notice. Please check with our sales representatives or product engineers before ordering.
- 2.This datasheet has only typical specifications because there is no space for detailed specifications. Therefore, please review our product specifications or consult the approval sheet for product specifications before ordering.

LQW18AS51NG0Z#

“#” indicates a package specification code.



Specifications

L size	1.6±0.2mm
W size	0.8±0.3mm
T size	0.8±0.2mm
Size code inch (mm)	0603 (1608)
Inductance	51nH±2%
Inductance Test Frequency	200MHz
Rated current (Itemp) (Based on Temperature rise)	600mA
Max. of DC resistance	0.27Ω
Operating Temperature Range (Self-temperature rise is included)	-40°C to 125°C
Q(min.)	35
Q Test Frequency	200MHz
Self resonance frequency (min.)	1900MHz
Brand	Murata
Series	LQW18AS_0Z

Attention

- 1.This datasheet is downloaded from the website of Murata Manufacturing Co., Ltd. Therefore, it's specifications are subject to change or our products in it may be discontinued without advance notice. Please check with our sales representatives or product engineers before ordering.
- 2.This datasheet has only typical specifications because there is no space for detailed specifications.
Therefore, please review our product specifications or consult the approval sheet for product specifications before ordering.

LQW18AS51NG0Z#

"#" indicates a package specification code.



Characteristic Data

The charts below may show another part number which shares its characteristics.

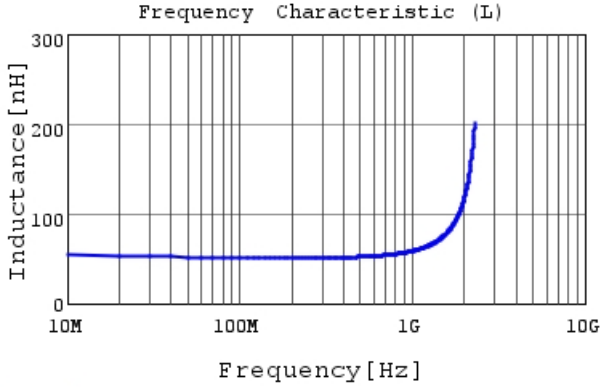

LQW18AS51NG0Z L

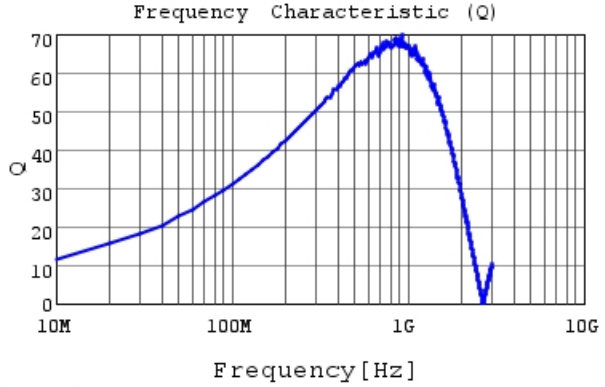

LQW18AS51NG0Z Q

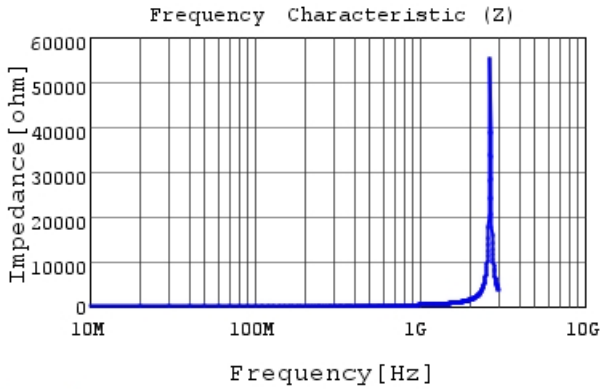

LQW18AS51NG0Z |Z|

Attention

- 1.This datasheet is downloaded from the website of Murata Manufacturing Co., Ltd. Therefore, it's specifications are subject to change or our products in it may be discontinued without advance notice. Please check with our sales representatives or product engineers before ordering.
- 2.This datasheet has only typical specifications because there is no space for detailed specifications. Therefore, please review our product specifications or consult the approval sheet for product specifications before ordering.