

CGJ2B2C0G1H121J050BA

TDK Item Description : CGJ2B2C0G1H121JT****



Application & Main Feature

High Reliability Grade (General (Up to 50V))

Series

CGJ2(1005) [EIA CC0402]

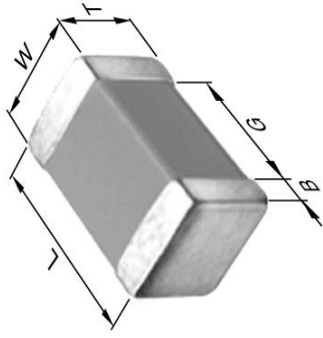

Dimensions

L	1.00mm	+/-0.05mm
W	0.50mm	+/-0.05mm
T	0.50mm	+/-0.05mm
B	0.10mm	Min.
G	0.30mm	Min.

Temperature Characteristic

C0G (-55 to 125 degC 0+/-30ppm/degC)

Rated Voltage

1H (50Vdc)

Capacitance

120pF

Capacitance Tolerance

J (+/-5%)

Q Factor

1000 Min.

Insulation Resistance

10Gohm Min.

AEC-Q200

Yes

|Z|, ESR vs. Freq. Characteristics

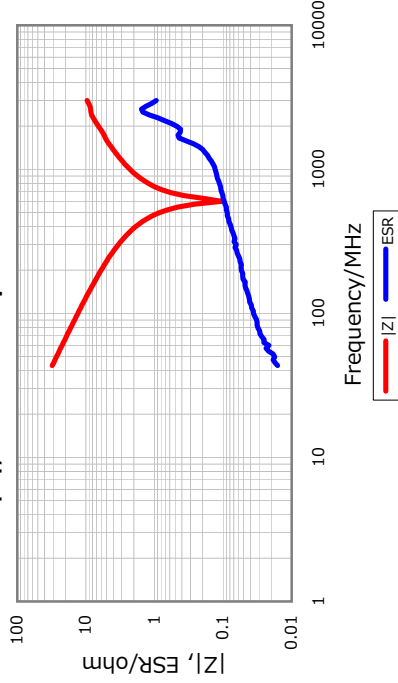

DC Bias Characteristic

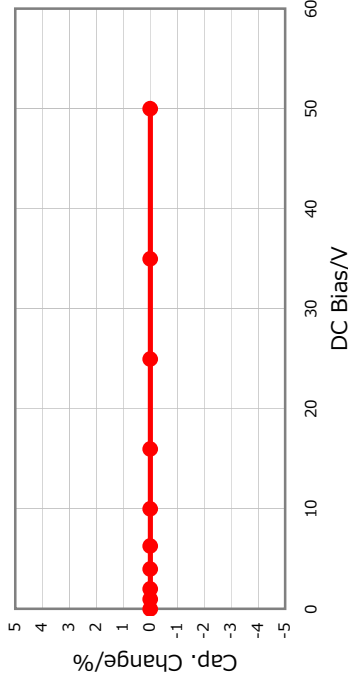

Cap. vs. Freq. Characteristic

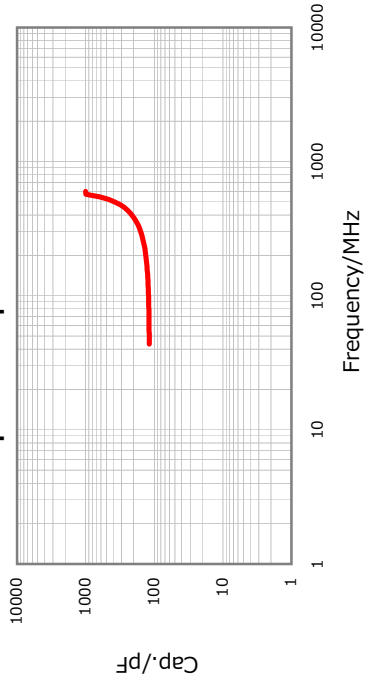

Temperature Characteristics

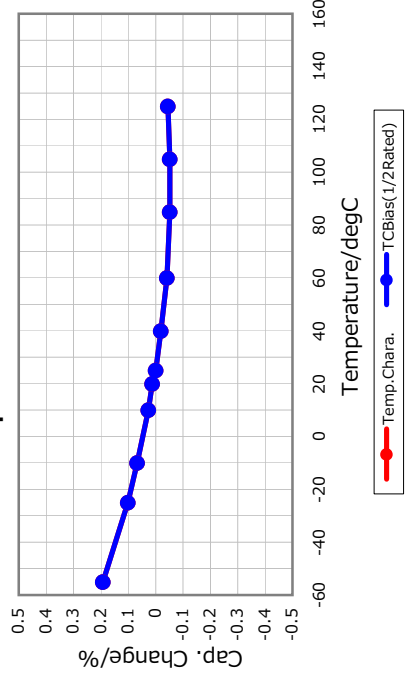

⚠ All specifications are subject to change without notice.

January 4, 2016