



# LT1587-1.5

## ABSOLUTE MAXIMUM RATINGS

$V_{IN}$  ..... 7V  
 Operating Junction Temperature Range  
     Control Section ..... 0°C to 125°C  
     Power Transistor ..... 0°C to 150°C

Storage Temperature Range ..... -65°C to 150°C  
 Lead Temperature (Soldering, 10 sec) ..... 300°C

## PRECONDITIONING

100% Thermal Limit Functional Test

## PACKAGE/ORDER INFORMATION

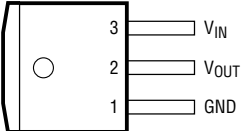
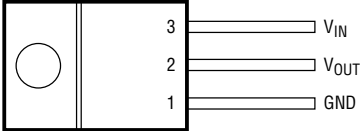
<p>FRONT VIEW</p>  <p>M PACKAGE 3-LEAD PLASTIC DD <math>\theta_{JA} = 30^{\circ}\text{C}/\text{W}^*</math></p>	<p>ORDER PART NUMBER</p> <p>LT1587CM-1.5</p>	<p>FRONT VIEW</p>  <p>T PACKAGE 3-LEAD PLASTIC TO-220 <math>\theta_{JA} = 50^{\circ}\text{C}/\text{W}</math></p>	<p>ORDER PART NUMBER</p> <p>LT1587CT-1.5</p>
---	--	--	--

\* With package soldered to 0.5 square inch copper area over backside ground plane or internal power plane.  $\theta_{JA}$  can vary from 20°C/W to >40°C/W with other mounting techniques.

Consult factory for Industrial and Military grade parts.

## ELECTRICAL CHARACTERISTICS

PARAMETER	CONDITIONS	MIN	TYP	MAX	UNITS
Output Voltage	$V_{IN} = 5\text{V}$ , $T_J = 25^{\circ}\text{C}$ , $I_{OUT} = 0\text{mA}$ $3\text{V} \leq V_{IN} \leq 7\text{V}$ , $0\text{mA} \leq I_{OUT} \leq 3\text{A}$	● 1.485 (-1%)	1.5	1.515 (+1%)	V
		1.470 (-2%)	1.5	1.530 (+2%)	V
Line Regulation (Notes 1, 2)	$3\text{V} \leq V_{IN} \leq 7\text{V}$ , $I_{OUT} = 0\text{mA}$		0.005	0.2	%
Load Regulation (Notes 1, 2, 3)	$V_{IN} = 5\text{V}$ , $T_J = 25^{\circ}\text{C}$ , $0\text{mA} \leq I_{OUT} \leq I_{FULL\ LOAD}$	●	0.05	0.3	%
			0.05	0.5	%
Dropout Voltage	$\Delta V_{OUT} = 1\%$ , $I_{OUT} = 3\text{A}$	●	1.150	1.300	V
Current Limit (Note 3)	$(V_{IN} - V_{OUT}) = 5.5\text{V}$	●	3.100	3.750	A
Quiescent Current	$V_{IN} = 5\text{V}$	●	7	13	mA
Ripple Rejection	$f = 120\text{Hz}$ , $C_{OUT} = 25\mu\text{F}$ Tant., $V_{IN} = 4.5\text{V}$ , $I_{OUT} = 3\text{A}$	●	60	72	dB
Thermal Regulation	$T_A = 25^{\circ}\text{C}$ , 30ms pulse		0.004	0.02	%/W
Temperature Stability		●	0.5		%
Long-Term Stability	$T_A = 125^{\circ}\text{C}$ , 1000 Hrs.		0.03	1.0	%
RMS Output Noise (% of $V_{OUT}$ )	$T_A = 25^{\circ}\text{C}$ , $10\text{Hz} \leq f \leq 10\text{kHz}$		0.003		%
Thermal Resistance Junction to Case	T Package: Control Circuitry/Power Transistor			0.7/3.0	°C/W
	M Package: Control Circuitry/Power Transistor			0.7/3.0	°C/W

The ● denotes specifications which apply over the specified operating temperature range.

**Note 1:** See thermal regulation specifications for changes in output voltage due to heating effects. Load and line regulation are measured at a constant junction temperature by low duty cycle pulse testing.

**Note 2:** Line and load regulation are guaranteed up to the maximum power dissipation (17W for the LT1587-1.5 in T package). Power

dissipation is determined by input/output differential and the output current. Guaranteed maximum output power will not be available over the full input/output voltage range.

**Note 3:**  $I_{FULL\ LOAD}$  is defined as the maximum value of output load current as a function of input-to-output voltage.  $I_{FULL\ LOAD}$  is equal to 3A. The LT1587-1.5 has constant current limit with changes in input-to-output voltage.

# TYPICAL PERFORMANCE CHARACTERISTICS

**Dropout Voltage vs Output Current**

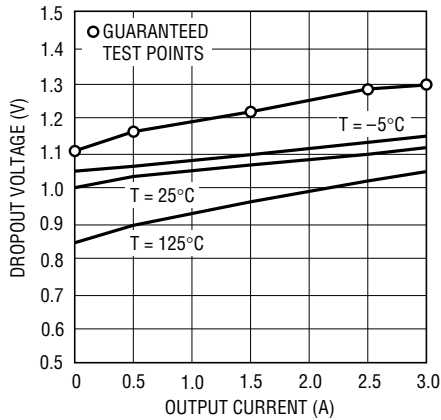

LT1587 • TPC01

**Short-Circuit Current vs Temperature**

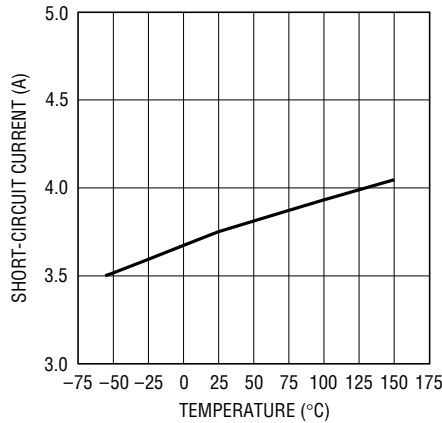

LT1587 • TPC02

**Load Regulation vs Temperature**

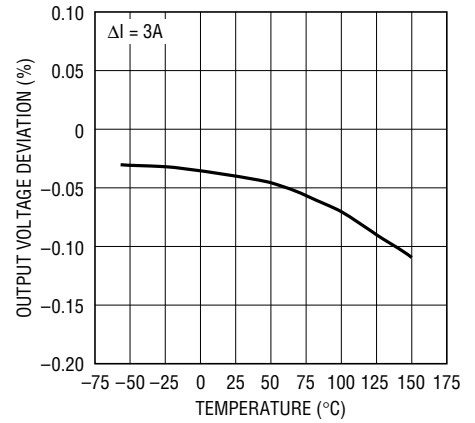

LT1587 • TPC03

**Output Voltage vs Temperature**

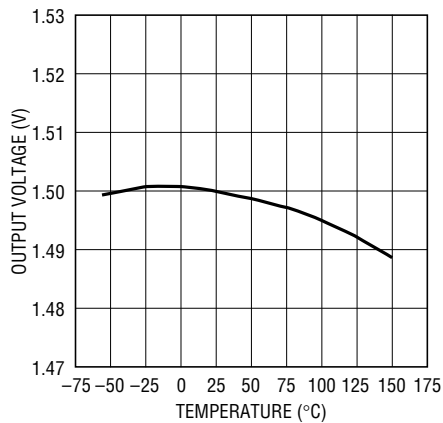

LT1587 • TPC04

**Quiescent Current vs Temperature**

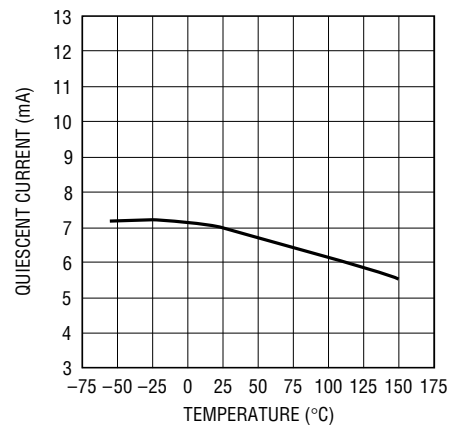

LT1587 • TPC05

**Ripple Rejection vs Frequency**

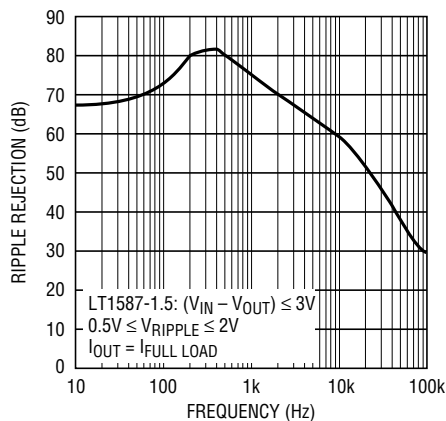

LT1587 • TPC06

**Maximum Power Dissipation\***

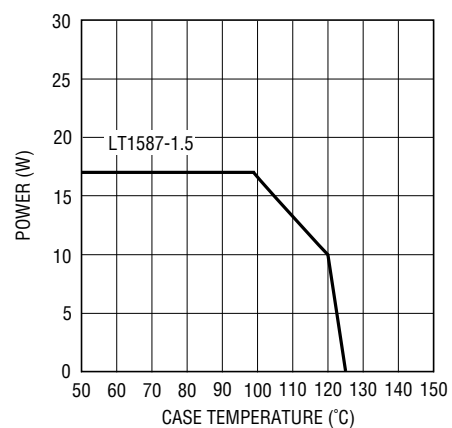

LT1587 • TPC07

\*AS LIMITED BY MAXIMUM JUNCTION TEMPERATURE

## SIMPLIFIED SCHEMATIC

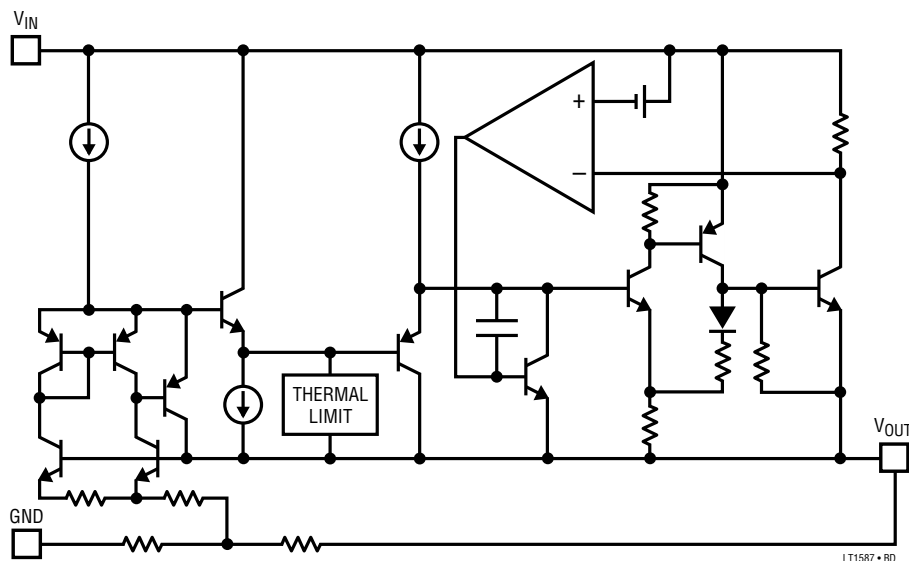

## APPLICATIONS INFORMATION

### General

The LT1587-1.5 3-terminal regulator is easy to use and has all the protection features expected in a high performance linear regulator. The device is short-circuit protected, safe-area protected and provides thermal shut-down to turn off the regulator if the junction temperature exceeds about 150°C.

The IC is pin compatible with the LT1083/LT1084/LT1085 family of linear regulators but offers lower dropout voltage and faster transient response. The trade-off for this improved performance is a 7V maximum supply voltage. Similar to the LT1083/LT1084/LT1085 family, the LT1587-1.5 regulator requires an output capacitor for stability. However, the improved frequency compensation permits the use of capacitors with much lower ESR while still maintaining stability. This is critical in addressing the needs of modern low voltage, high speed microprocessors.

Current generation microprocessors and their associated circuitry cycle load current from almost zero to several amps in tens of nanoseconds. Output voltage tolerances are tighter and include transient response as part of the specification. The LT1587-1.5 is specifically designed to meet the fast current load step requirements of these

applications and saves total cost by needing less output capacitance in order to maintain regulation.

### Stability

The circuit design in the LT1587-1.5 requires the use of an output capacitor as part of the frequency compensation. For all operating conditions, the addition of a 22 $\mu$ F solid tantalum or a 100 $\mu$ F aluminum electrolytic on the output ensures stability. Normally, the LT1587-1.5 can use smaller value capacitors. Many different types of capacitors are available and have widely varying characteristics. These capacitors differ in capacitor tolerance (sometimes ranging up to  $\pm 100\%$ ), equivalent series resistance, equivalent series inductance and capacitance temperature coefficient. The LT1587-1.5 frequency compensation optimizes frequency response with low ESR capacitors. In general, use capacitors with an ESR of less than 1 $\Omega$ .

Normally, capacitor values on the order of several hundred microfarads are used on the output of the regulators to ensure good transient response with heavy load current changes. Output capacitance can increase without limit and larger values of output capacitance further improve the stability and transient response of the LT1587-1.5.

## APPLICATIONS INFORMATION

Large load current changes are exactly the situation presented by modern microprocessors and their peripheral circuitry. The load current step contains higher order frequency components that the output decoupling network must handle until the regulator throttles to the load current level. Capacitors are not ideal elements and contain parasitic resistance and inductance. These parasitic elements dominate the change in output voltage at the beginning of a transient load step change. The ESR of the output capacitors produces an instantaneous step in output voltage [ $\Delta V = \Delta I(\text{ESR})$ ]. The ESL of the output capacitors produces a droop proportional to the rate of change of output current [ $V = L(\Delta I/\Delta t)$ ]. The output capacitance produces a change in output voltage proportional to the time until the regulator can respond [ $\Delta V = \Delta t(\Delta I/C)$ ]. These transient effects are illustrated in Figure 1.

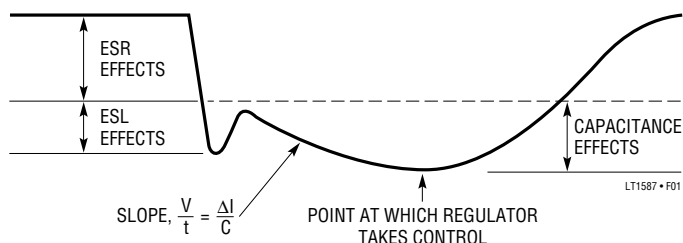

Figure 1

The use of capacitors with low ESR, low ESL and good high frequency characteristics is critical in meeting the output voltage tolerances of these high speed microprocessor applications. These requirements dictate a combination of high quality surface mount tantalum capacitors and ceramic capacitors. The location of the decoupling network is critical to transient response performance. Place the decoupling network as close as possible to the microprocessor control circuitry because a trace run from the decoupling capacitors to the actual circuitry is inductive. In addition, use large power and ground plane areas to minimize distribution drops.

A possible stability problem that occurs in monolithic linear regulators is current limit oscillations. The LT1587-1.5 essentially has a flat current limit over the range of input supply voltage. The lower current limit rating and 7V maximum supply voltage rating for this device permits this characteristic. Current limit oscillations are typically non-existent unless the input and output decoupling capacitors

for the regulators are mounted several inches from the terminals.

### Protection Diodes

In normal operation, the LT1587-1.5 does not require any protection diodes. Older 3-terminal regulators require protection diodes between the output pin and the input pin to prevent die overstress.

A protection diode between the input and output pins is usually not needed. An internal diode between the input and output pins on the LT1587-1.5 can handle microsecond surge currents of 50A to 100A. Even with large value output capacitors it is difficult to obtain those values of surge currents in normal operation. Only with large values of output capacitance, such as 1000 $\mu$ F to 5000 $\mu$ F, and with the input pin instantaneously shorted to ground can damage occur. A crowbar circuit at the input of the LT1587-1.5 can generate those levels of current, and a diode from output to input is then recommended. This is shown in Figure 2. Usually, normal power supply cycling or system "hot plugging and unplugging" will not generate current large enough to do any damage.

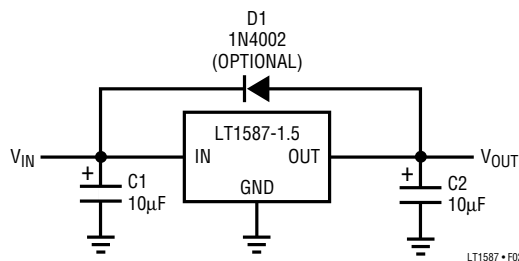

Figure 2

### Ripple Rejection

The typical curve for ripple rejection reflects values for the LT1587-1.5 as a function of frequency. In applications that require improved ripple rejection, use the adjustable LT1587. A bypass capacitor from the adjust pin to ground reduces the output ripple by the ratio of  $V_{OUT}/1.25V$ .

### Load Regulation

It is not possible to provide true remote load sensing because the LT1587-1.5 is a 3-terminal device. Load

## APPLICATIONS INFORMATION

regulation is limited by the resistance of the wire connecting the regulators to the load. Load regulation per the data sheet specification is measured at the bottom of the package.

For fixed voltage devices, negative side sensing is a true Kelvin connection with the Ground pin of the device returned to the negative side of the load. This is illustrated in Figure 3.

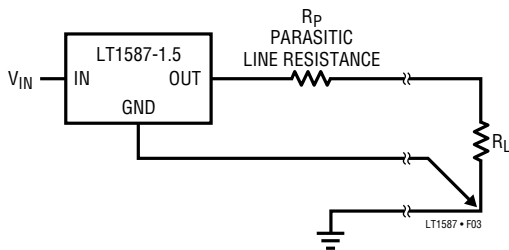

Figure 3. Connection for Best Load Regulation

### Thermal Considerations

The LT1587-1.5 protects the device under overload conditions with internal power and thermal limiting circuitry. However, for normal continuous load conditions, do not exceed maximum junction temperature ratings. It is important to consider all sources of thermal resistance from junction-to-ambient. These sources include the junction-to-case resistance, the case-to-heat sink interface resistance, and the heat sink resistance. Thermal resistance specifications have been developed to more accurately reflect device temperature and ensure safe operating temperatures. The electrical characteristics section provides a separate thermal resistance and maximum junction temperature for both the control circuitry and the power transistor. Older regulators with a single junction-to-case thermal resistance specification, use an average of the two values provided here and allow excessive junction temperatures under certain conditions of ambient temperature and heat sink resistance. Calculate the maximum junction temperature for both sections to ensure that both thermal limits are met.

Junction-to-case thermal resistance is specified from the IC junction to the bottom of the case directly below the die. This is the lowest resistance path for heat flow. Proper mounting ensures the best thermal flow from this area of the package to the heat sink. Linear Technology strongly recommends thermal compound at the case-to-heat sink interface. Use a thermally conductive spacer if the case of the device must be electrically isolated and include its contribution to the total thermal resistance. Please consult “Mounting Considerations for Power Semiconductors” *1990 Linear Applications Handbook, Volume I*, Pages RR3-1 to RR3-20. The output connects to the case of the device in the LT1587-1.5.

For example, using an LT1587CT-1.5 (TO-220, commercial) and assuming:

$$V_{IN}(\text{Max Continuous}) = 3.465\text{V} (3.3\text{V} + 5\%), V_{OUT} = 1.5\text{V}$$

$$I_{OUT} = 3\text{A}$$

$$T_A = 70^\circ\text{C}, \theta_{\text{HEAT SINK}} = 7^\circ\text{C/W}$$

$$\theta_{\text{CASE-TO-HEAT SINK}} = 1^\circ\text{C/W} \text{ (with Thermal Compound)}$$

Power dissipation under these conditions is equal to:

$$P_D = (V_{IN} - V_{OUT})(I_{OUT}) = (3.465 - 1.5)(3\text{A}) = 5.895\text{W}$$

Junction temperature will be equal to:

$$T_J = T_A + P_D(\theta_{\text{HEAT SINK}} + \theta_{\text{CASE-TO-HEAT SINK}} + \theta_{JC})$$

For the Control Section:

$$T_J = 70^\circ\text{C} + 5.895\text{W} (7^\circ\text{C/W} + 1^\circ\text{C/W} + 0.7^\circ\text{C/W}) = 121.3^\circ\text{C}$$

$$121.3^\circ\text{C} < 125^\circ\text{C} = T_{J\text{MAX}} \text{ (Control Section Commercial Range)}$$

For the Power Transistor:

$$T_J = 70^\circ\text{C} + 5.895\text{W} (7^\circ\text{C/W} + 1^\circ\text{C/W} + 3^\circ\text{C/W}) = 134.8^\circ\text{C}$$

$$134.8^\circ\text{C} < 150^\circ\text{C} = T_{J\text{MAX}} \text{ (Power Transistor Commercial Range)}$$

In both cases the junction temperature is below the maximum rating for the respective sections, ensuring reliable operation.

**PACKAGE DESCRIPTION** Dimensions in inches (millimeters) unless otherwise noted.

**M Package**  
**3-Lead Plastic DD Pak**  
 (LTC DWG # 05-08-1460)

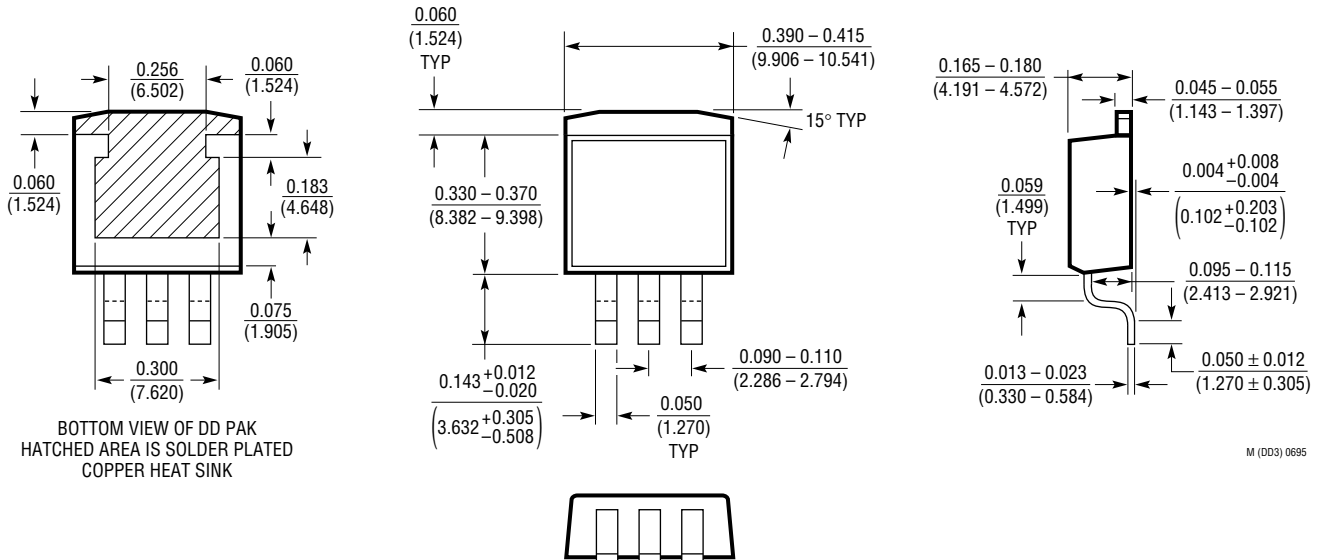

**T Package**  
**3-Lead Plastic TO-220**  
 (LTC DWG # 05-08-1420)

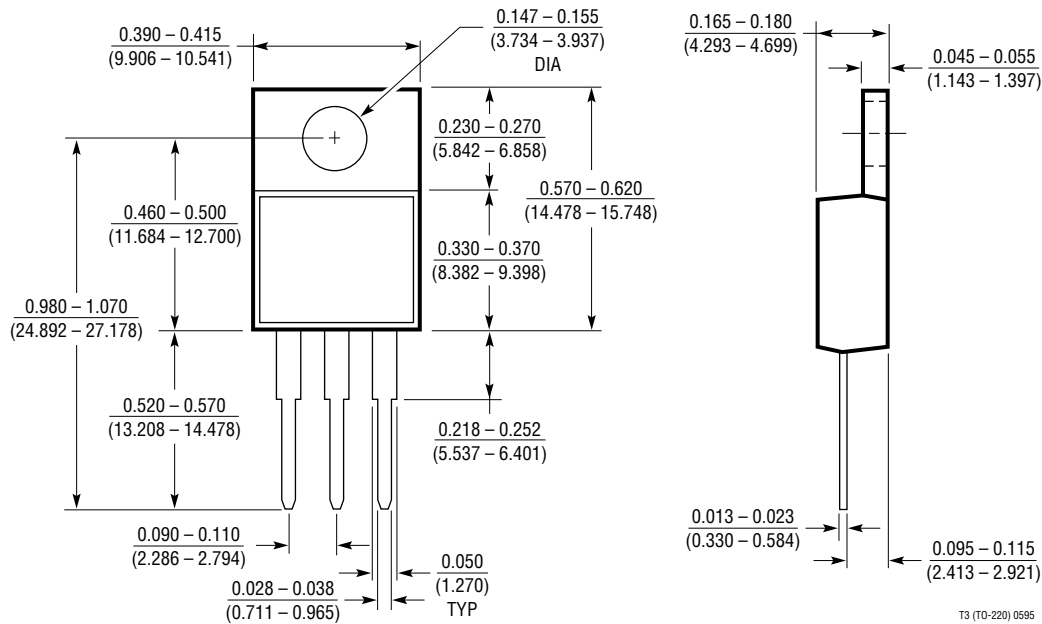

## RELATED PARTS

PART NUMBER	DESCRIPTION	COMMENTS
LTC®1392	Micropower Temperature, Power Supply and Differential Voltage Monitor	Micropower Data Acquisition to Monitor System
LTC1430	High Power Step-Down Switching Regulator Controller	5V to 3.3V at 10A or More
LTC1472	Protected PCMCIA $V_{CC}$ and $V_{PP}$ Switching Matrix	Single-Slot Power Switch
LT1580	Very Low Dropout 7A Linear Regulator	0.54V Dropout at 7A, Fixed 2.5V <sub>OUT</sub> or Adjustable