

NFL21SP706X1C3#

"#" indicates a package specification code.

In Production

RoHS

REACH

< List of part numbers with package codes >

NFL21SP706X1C3B

NFL21SP706X1C3D

Appearance & Shape

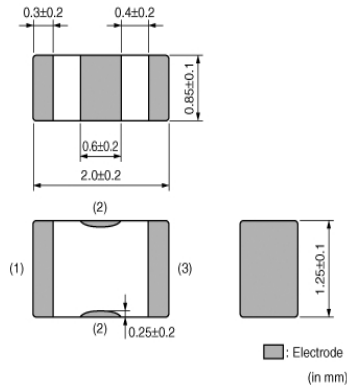
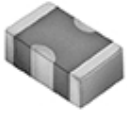

Features

The chip "EMIFIL" NFL21SP series is a high performance EMI suppression filter in 2.0x1.25mm size for high speed signal lines by using Murata's processing technology.

Features

1. Suppresses noise with little attenuation of the signal itself due to its steep filtering characteristics.
2. Murata's original internal structure design enables excellent noise suppression up to high frequencies.
3. Available in ten different values of cut-off frequency ranging from 10MHz up to 500MHz.

Applications

Suppression of high magnitude radiated noise generated by high speed digital circuits such as clock and RGB

Applications

Other Usage	For general
-------------	-------------

Packaging Information

Packaging	Specifications	Standard Packing Quantity
B	Bulk(Bag)	1000
D	180mm Paper Tape	4000

Attention

1.This datasheet is downloaded from the website of Murata Manufacturing Co., Ltd. Therefore, it's specifications are subject to change or our products in it may be discontinued without advance notice. Please check with our sales representatives or product engineers before ordering.

2.This datasheet has only typical specifications because there is no space for detailed specifications.

Therefore, please review our product specifications or consult the approval sheet for product specifications before ordering.

NFL21SP706X1C3#

“#” indicates a package specification code.



Specifications

Shape	SMD
Size Code (in inch)	0805
Length	2.0mm
Length Tolerance	±0.2mm
Width	1.25mm
Width Tolerance	±0.1mm
Thickness	0.85mm
Thickness Tolerance	±0.1mm
Operating Temperature Range	-55°C to 125°C
Mass(typ.)	0.009g
Number of Circuit	1
Rated Current	150mA
Rated Voltage	16Vdc
Withstanding Voltage	50Vdc
Insulation Resistance(min.)	1000MΩ
Nominal Cut-off Frequency	70MHz
Capacitance	76pF
Capacitance Tolerance	±20%
Inductance	185nH
Inductance Tolerance	±20%
Size Code (in mm)	2012

Attention

1.This datasheet is downloaded from the website of Murata Manufacturing Co., Ltd. Therefore, it's specifications are subject to change or our products in it may be discontinued without advance notice. Please check with our sales representatives or product engineers before ordering.

2.This datasheet has only typical specifications because there is no space for detailed specifications.

Therefore, please review our product specifications or consult the approval sheet for product specifications before ordering.

NFL21SP706X1C3#

“#” indicates a package specification code.

Product Data

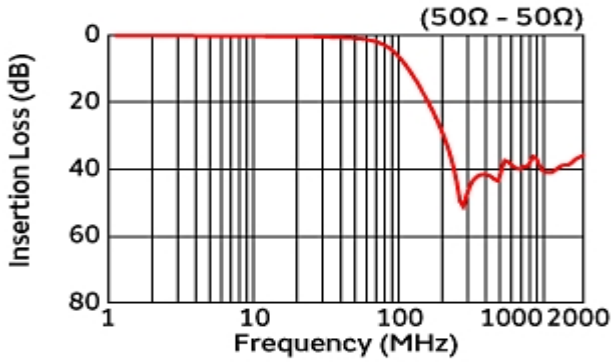

Insertion Loss Characteristics

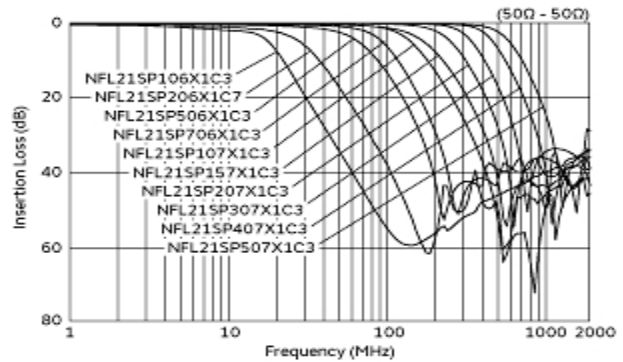

Insertion Loss Characteristics (Main Items)

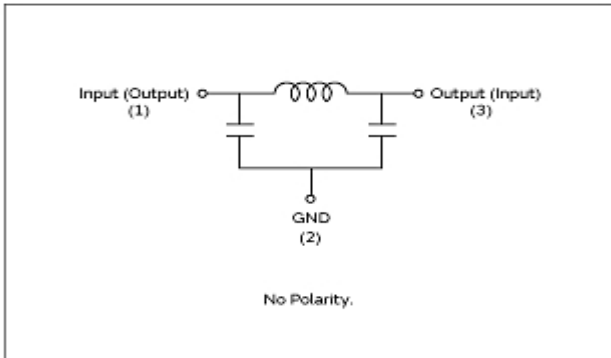

Equivalent Circuit

Attention

- 1.This datasheet is downloaded from the website of Murata Manufacturing Co., Ltd. Therefore, it's specifications are subject to change or our products in it may be discontinued without advance notice. Please check with our sales representatives or product engineers before ordering.
- 2.This datasheet has only typical specifications because there is no space for detailed specifications.
Therefore, please review our product specifications or consult the approval sheet for product specifications before ordering.