

LQH31HNR39K03#

“#” indicates a package specification code.

Size Code 3216 (1206) in mm (in inch), Ferrite Core High Frequency Wound Type



< List of part numbers with package codes >

LQH31HNR39K03K LQH31HNR39K03L

Appearance & Shape

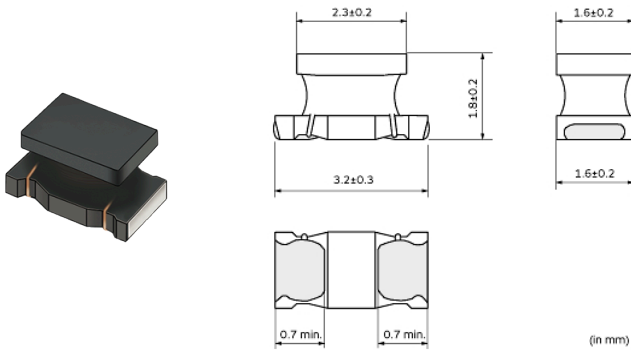

References

Packaging	Specifications	Standard Packing Quantity
K	330Embossed Tape	7500
L	180Embossed Tape	2000

Mass (typ.)	
1 piece	0.029g

Attention

- 1.This datasheet is downloaded from the website of Murata Manufacturing Co., Ltd. Therefore, it's specifications are subject to change or our products in it may be discontinued without advance notice. Please check with our sales representatives or product engineers before ordering.
- 2.This datasheet has only typical specifications because there is no space for detailed specifications. Therefore, please review our product specifications or consult the approval sheet for product specifications before ordering.

LQH31HNR39K03#

“#” indicates a package specification code.



Specifications

L size	3.2±0.3mm
W size	1.6±0.2mm
T size	1.8±0.2mm
Size code inch (mm)	1206 (3216)
Inductance	390nH±10%
Inductance Test Frequency	1MHz
Rated current (Itemp) (Based on Temperature rise)	330mA
Max. of DC resistance	0.338Ω
Q(min.)	60
Q Test Frequency	100MHz
Self resonance frequency (min.)	300MHz
Operating Temperature Range(Self-temperature rise is not included)	-40°C to 85°C
Brand	Murata
DC Resistance Intermediate Values	0.26Ω±30%
Series	LQH31HN_03

Attention

1.This datasheet is downloaded from the website of Murata Manufacturing Co., Ltd. Therefore, it's specifications are subject to change or our products in it may be discontinued without advance notice. Please check with our sales representatives or product engineers before ordering.

2.This datasheet has only typical specifications because there is no space for detailed specifications.

Therefore, please review our product specifications or consult the approval sheet for product specifications before ordering.

LQH31HNR39K03#

“#” indicates a package specification code.



Characteristic Data

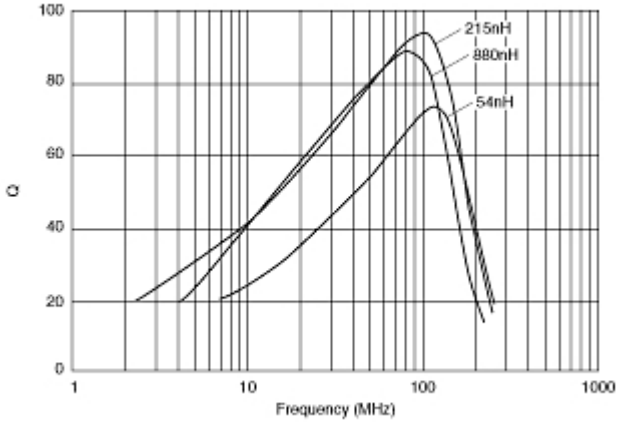

Q-Frequency Characteristics

Attention

- 1.This datasheet is downloaded from the website of Murata Manufacturing Co., Ltd. Therefore, it's specifications are subject to change or our products in it may be discontinued without advance notice. Please check with our sales representatives or product engineers before ordering.
- 2.This datasheet has only typical specifications because there is no space for detailed specifications. Therefore, please review our product specifications or consult the approval sheet for product specifications before ordering.