

# CGJ3E2C0G1H681J080AA

TDK Item Description : CGJ3E2C0G1H681JT\*\*\*



## Application & Main Feature

High Reliability Grade ( General (Up to 50V) )

## Series

CGJ3(1608) [EIA CC0603]

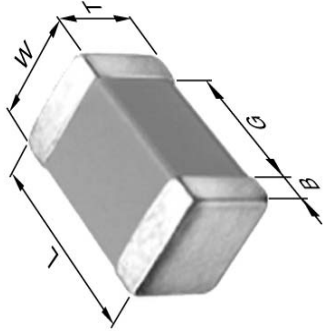

## Dimensions

L	1.60mm	+/-0.1mm
W	0.80mm	+/-0.1mm
T	0.80mm	+/-0.1mm
B	0.20mm	Min.
G	0.30mm	Min.

## Temperature Characteristic

C0G (-55 to 125 degC 0+/-30ppm/degC)

## Rated Voltage

1H (50Vdc)

## Capacitance

680pF

## Capacitance Tolerance

J (+/-5%)

## Q Factor

1000 Min.

## Insulation Resistance

10Gohm Min.

## AEC-Q200

Yes

## |Z|, ESR vs. Freq. Characteristics

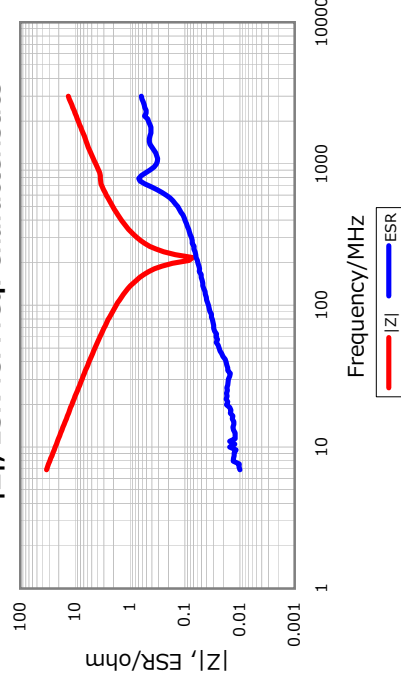

## DC Bias Characteristic

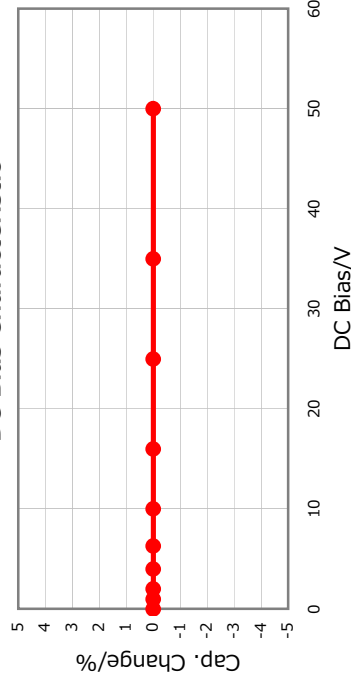

## Cap. vs. Freq. Characteristic

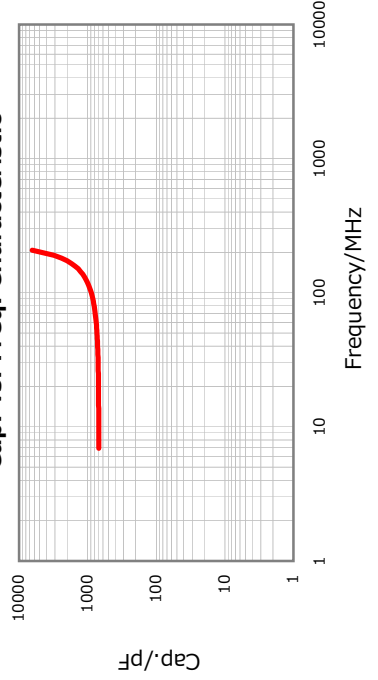

## Temperature Characteristics

