

LQH5BPB220MT0#

"#" indicates a package specification code.

105°C Operation Available



< List of part numbers with package codes >

LQH5BPB220MT0K LQH5BPB220MT0L

Appearance & Shape

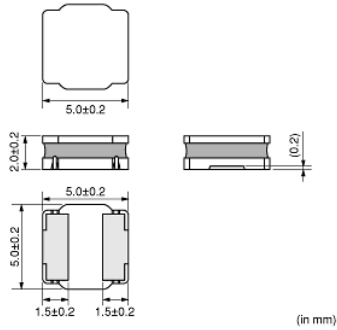
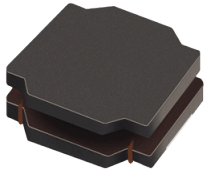

References

Packaging	Specifications	Standard Packing Quantity
K	330Embossed Tape	3000
L	180Embossed Tape	500

Mass (typ.)	
1 piece	0.22g

Notices

When rated current is applied to the products, inductance will be within $\pm 30\%$ of nominal inductance value. When rated current is applied to the products, the temperature rise caused by self-generated heat shall be limited to 40°C max. Keep the temperature (ambient temperature plus self-generation of heat) under 125°C.

Attention

- 1.This datasheet is downloaded from the website of Murata Manufacturing Co., Ltd. Therefore, it's specifications are subject to change or our products in it may be discontinued without advance notice. Please check with our sales representatives or product engineers before ordering.
- 2.This datasheet has only typical specifications because there is no space for detailed specifications. Therefore, please review our product specifications or consult the approval sheet for product specifications before ordering.

LQH5BPB220MT0#

“#” indicates a package specification code.



Specifications

L size	5.0±0.2mm
W size	5.0±0.2mm
T size	2.0±0.2mm
Size code inch (mm)	2020 (5050)
Inductance	22μH±20%
Inductance Test Frequency	100kHz
Rated current (Isat) (Based on Inductance change)	1.4A
Rated current (Itemp) (Based on Temperature rise)	1.05A(Ambient temp.85°C)0.55A(Ambient temp.105°C)
Max. of DC resistance	0.3108Ω
Operating Temperature Range (Self-temperature rise is included)	-40°C to 125°C
Class of magnetic shield	Magnetic Resin
Self resonance frequency (min.)	15MHz
Operating Temperature Range(Self-temperature rise is not included)	-40°C to 105°C
Brand	Murata
DC Resistance Intermediate Values	0.259Ω±20%
Series	LQH5BPB_T0

Attention

1.This datasheet is downloaded from the website of Murata Manufacturing Co., Ltd. Therefore, it's specifications are subject to change or our products in it may be discontinued without advance notice. Please check with our sales representatives or product engineers before ordering.

2.This datasheet has only typical specifications because there is no space for detailed specifications.

Therefore, please review our product specifications or consult the approval sheet for product specifications before ordering.

LQH5BPPB220MT0#

"#" indicates a package specification code.



Characteristic Data

The charts below may show another part number which shares its characteristics.

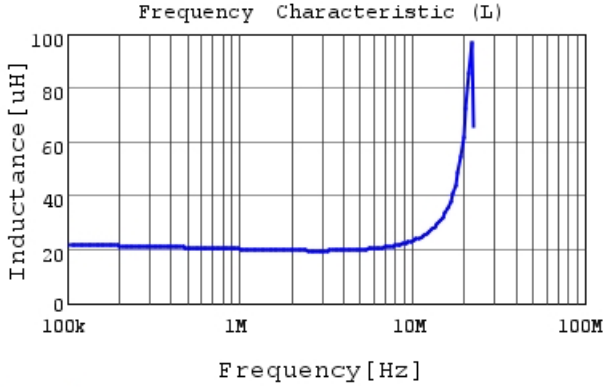

LQH5BPPB220MT0 L

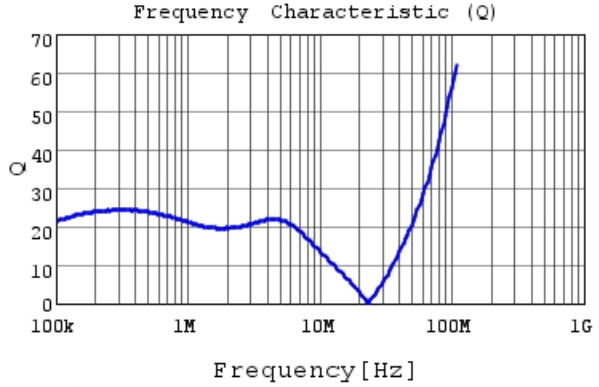

LQH5BPPB220MT0 Q

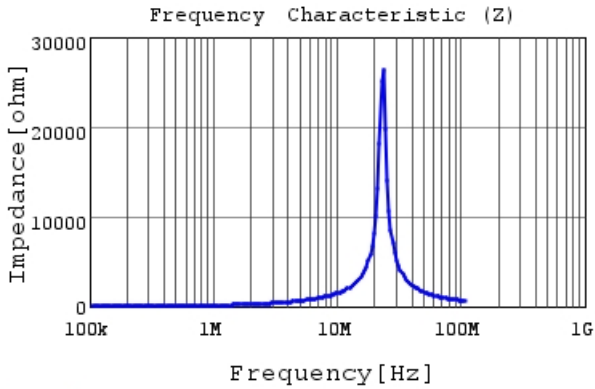

LQH5BPPB220MT0 |Z|

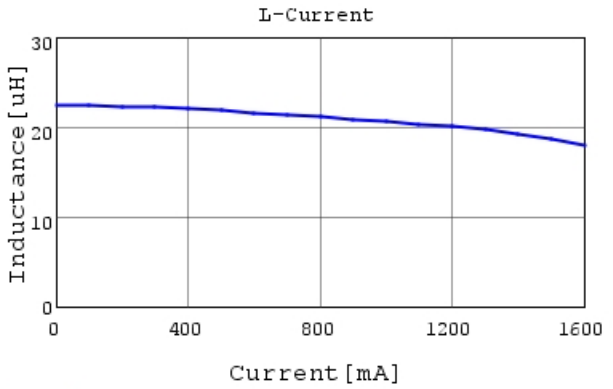

LQH5BPPB220MT0 L-Current 20degC

Attention

- 1.This datasheet is downloaded from the website of Murata Manufacturing Co., Ltd. Therefore, it's specifications are subject to change or our products in it may be discontinued without advance notice. Please check with our sales representatives or product engineers before ordering.
- 2.This datasheet has only typical specifications because there is no space for detailed specifications. Therefore, please review our product specifications or consult the approval sheet for product specifications before ordering.

LQH5BPB220MT0#

“#” indicates a package specification code.

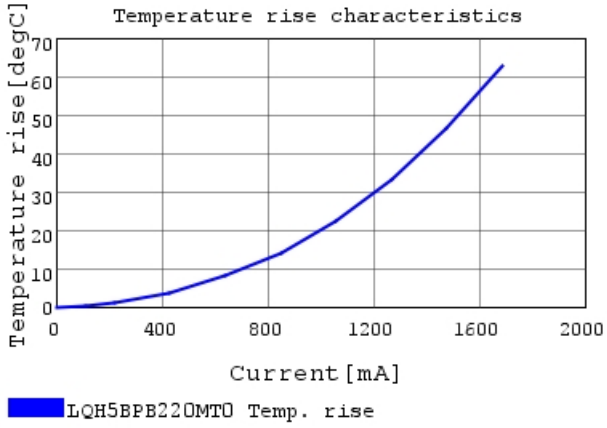

Attention

- 1.This datasheet is downloaded from the website of Murata Manufacturing Co., Ltd. Therefore, it's specifications are subject to change or our products in it may be discontinued without advance notice. Please check with our sales representatives or product engineers before ordering.
- 2.This datasheet has only typical specifications because there is no space for detailed specifications.
Therefore, please review our product specifications or consult the approval sheet for product specifications before ordering.