

# C1608JB2A152K080AA

TDK Item Description : C1608JB2A152KT\*\*\*\*



## Application & Main Feature

Commercial Grade ( Mid Voltage (100 to 630V) )

## Series

C1608 [EIA CC0603]

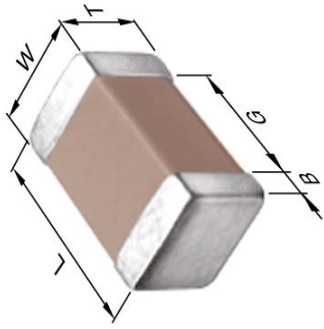

## DC Bias Characteristic

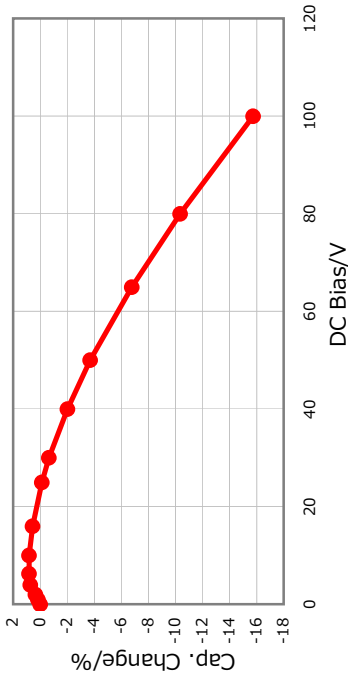

## |Z|, ESR vs. Freq. Characteristics

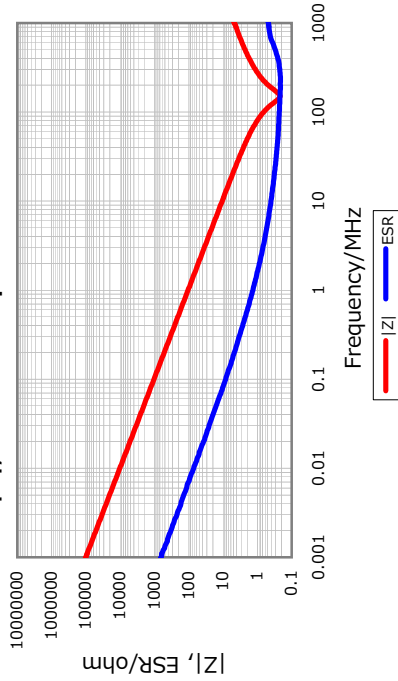

## Temperature Characteristics

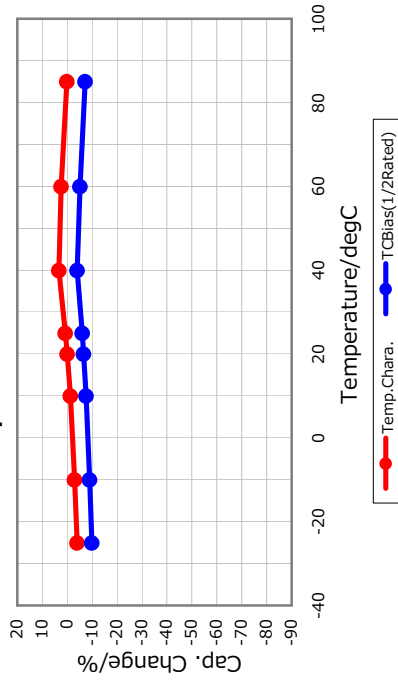

## Cap. vs. Freq. Characteristic

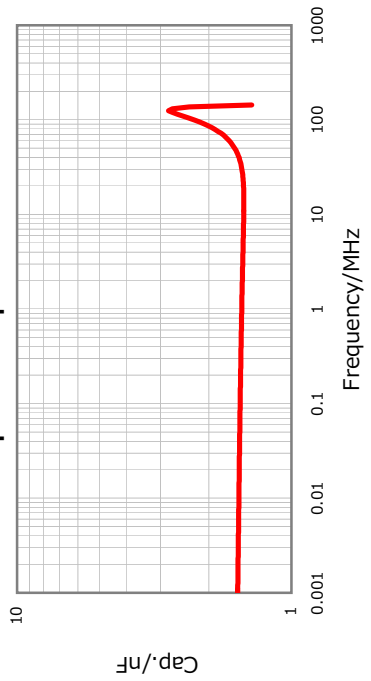

## Ripple Temperature Rise Characteristics

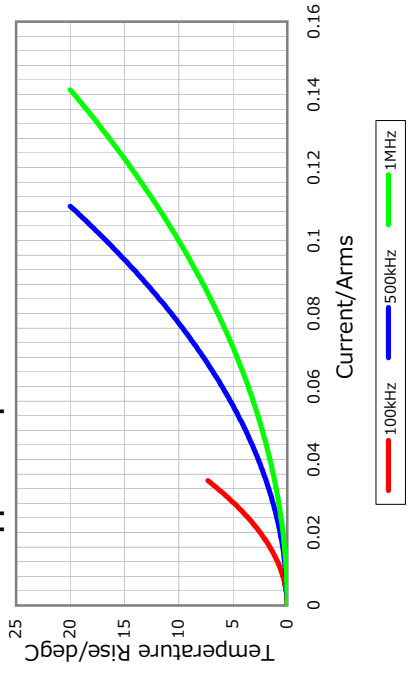

## Dimensions

- L 1.60mm +/-0.1mm
- W 0.80mm +/-0.1mm
- T 0.80mm +/-0.1mm
- B 0.20mm Min.
- G 0.30mm Min.

## Temperature Characteristic

JB (-25 to 85 degC +/-10%)

## Rated Voltage

2A (100Vdc)

## Capacitance

1.5nF

## Capacitance Tolerance

K (+/-10%)

## Dissipation Factor

3% Max.

## Insulation Resistance

10Gohm Min.

## AEC-Q200

Not Applicable



All specifications are subject to change without notice.

January 3, 2016