

LQH3NPN470MJ0#

“#” indicates a package specification code.

Size Code 3030 (1212) in mm (in inch), 1.2mm max. Thickness



< List of part numbers with package codes >
LQH3NPN470MJ0K LQH3NPN470MJ0L

Appearance & Shape

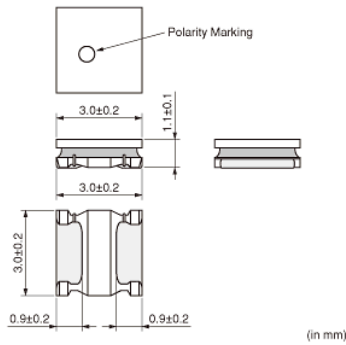
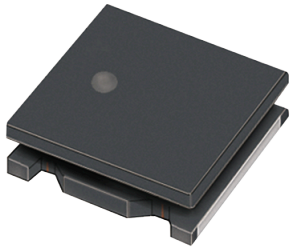

References

Packaging	Specifications	Standard Packing Quantity
K	330Embossed Tape	5000
L	180Embossed Tape	1000

Mass (typ.)	
1 piece	0.045g

Notices

When rated current is applied to the products, inductance will be within $\pm 30\%$ of nominal inductance value. When rated current is applied to the products, the temperature rise caused by self-generated heat shall be limited to 40°C max. Keep the temperature (ambient temperature plus self-generation of heat) under 125°C.

Attention

- 1.This datasheet is downloaded from the website of Murata Manufacturing Co., Ltd. Therefore, it's specifications are subject to change or our products in it may be discontinued without advance notice. Please check with our sales representatives or product engineers before ordering.
- 2.This datasheet has only typical specifications because there is no space for detailed specifications. Therefore, please review our product specifications or consult the approval sheet for product specifications before ordering.

LQH3NPN470MJ0#

“#” indicates a package specification code.



Specifications

L size	3.0±0.2mm
W size	3.0±0.2mm
T size	1.1±0.1mm
Size code inch (mm)	1212 (3030)
Inductance	47μH±20%
Inductance Test Frequency	1MHz
Rated current (Isat) (Based on Inductance change)	200mA
Rated current (Itemp) (Based on Temperature rise)	350mA
Max. of DC resistance	1.56Ω
Operating Temperature Range (Self-temperature rise is included)	-40°C to 125°C
Class of magnetic shield	Magnetic Resin
Self resonance frequency (min.)	15MHz
Operating Temperature Range (Self-temperature rise is not included)	-40°C to 85°C
Brand	Murata
DC Resistance Intermediate Values	1.30Ω±20%
Series	LQH3NPN_J0

Attention

- 1.This datasheet is downloaded from the website of Murata Manufacturing Co., Ltd. Therefore, it's specifications are subject to change or our products in it may be discontinued without advance notice. Please check with our sales representatives or product engineers before ordering.
- 2.This datasheet has only typical specifications because there is no space for detailed specifications. Therefore, please review our product specifications or consult the approval sheet for product specifications before ordering.

LQH3NPN470MJ0#

"#" indicates a package specification code.

Characteristic Data

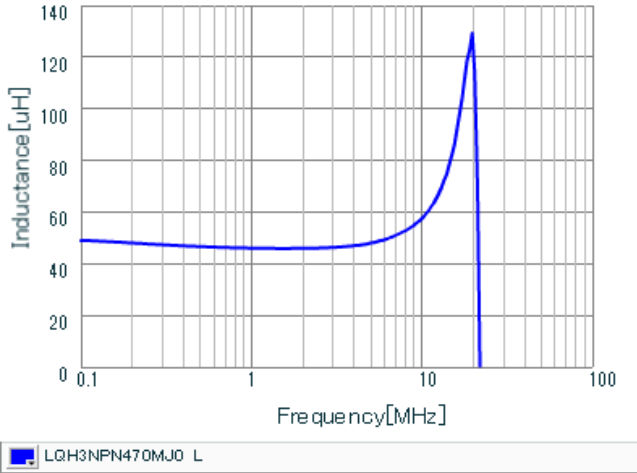

Inductance - Frequency Characteristics

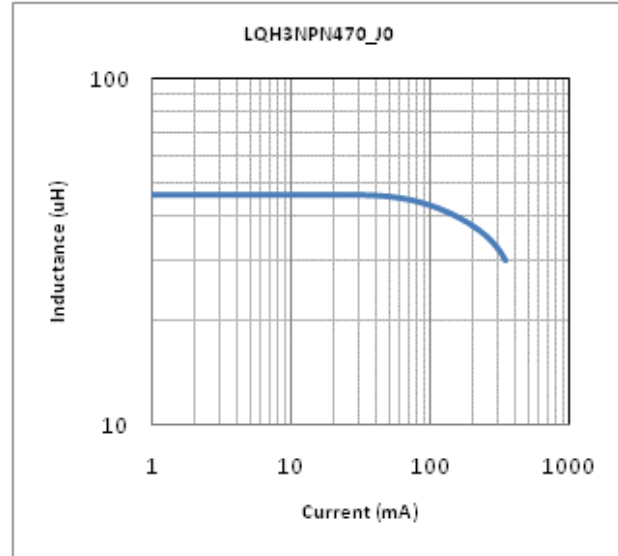

Impedance - Current Characteristics

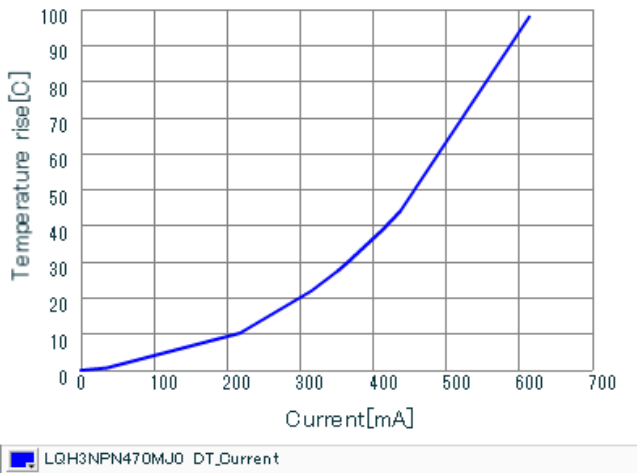

Temperature Increase Characteristic

Attention

- 1.This datasheet is downloaded from the website of Murata Manufacturing Co., Ltd. Therefore, it's specifications are subject to change or our products in it may be discontinued without advance notice. Please check with our sales representatives or product engineers before ordering.
- 2.This datasheet has only typical specifications because there is no space for detailed specifications. Therefore, please review our product specifications or consult the approval sheet for product specifications before ordering.