

FEATURES

- ±1.2% accuracy over line and load regulations @ 25°C
- Ultralow dropout voltage: 120 mV typical @ 100 mA
- Requires only $C_{OUT} = 0.47 \mu\text{F}$ for stability
- anyCAP LDOs are stable with all types of capacitors (including MLCC)
- Current and thermal limiting
- Low noise
- Low shutdown current: 1 μA
- 2.8 V to 12 V supply range
- 20°C to +85°C ambient temperature range
- Several fixed voltage options
- Ultrasmall 5-lead SOT-23 package
- Excellent line and load regulations

APPLICATIONS

- Cellular telephones
- Notebook, palmtop computers
- Battery-powered systems
- PCMCIA regulator
- Bar code scanners
- Camcorders, cameras

GENERAL DESCRIPTION

The ADP3309 is a member of the ADP330x family of precision low dropout anyCAP voltage regulators. It is pin-for-pin and functionally compatible with National's LP2981, but offers performance advantages. The ADP3309 stands out from conventional LDOs with a novel architecture and an enhanced process. Its patented design requires only a 0.47 μF output capacitor for stability. This device is stable with any type of capacitor regardless of its equivalent series resistance (ESR) value, including ceramic types for space restricted applications. The ADP3309 achieves $\pm 1.2\%$ accuracy at room temperature and $\pm 2.2\%$ overall accuracy over temperature, line, and load regulations. The dropout voltage of the ADP3309 is only 120 mV (typical) at 100 mA. This device also includes a current limit and a shutdown feature. In shutdown mode, the ground current is reduced to $\sim 1 \mu\text{A}$.

FUNCTIONAL BLOCK DIAGRAM

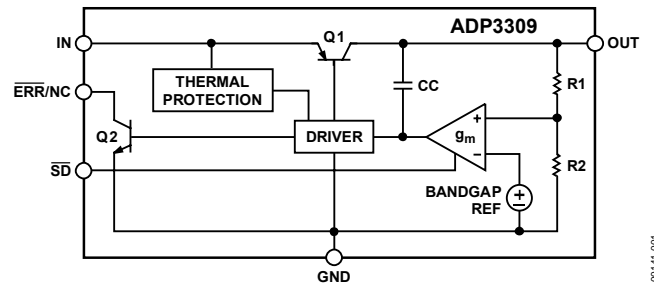

Figure 1.

00144-001

The ADP3309 operates with a wide input voltage range from 2.8 V to 12 V and delivers a load current in excess of 100 mA. The ADP3309 anyCAP LDO offers a wide range of output voltages.

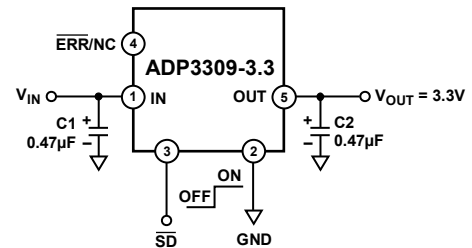

Figure 2. Typical Application Circuit

00144-002

Rev. C

Information furnished by Analog Devices is believed to be accurate and reliable. However, no responsibility is assumed by Analog Devices for its use, nor for any infringements of patents or other rights of third parties that may result from its use. Specifications subject to change without notice. No license is granted by implication or otherwise under any patent or patent rights of Analog Devices. Trademarks and registered trademarks are the property of their respective owners.

TABLE OF CONTENTS

Features	1	Capacitor Selection: anyCAP	10
Applications	1	Thermal Overload Protection	10
Functional Block Diagram	1	Calculating Junction Temperature	10
General Description	1	Printed Circuit Board Layout Consideration	10
Revision History	2	Shutdown Mode	10
Specifications	3	Error Flag Dropout Detector	10
Absolute Maximum Ratings	4	Application Circuits	11
ESD Caution	4	Crossover Switch	11
Pin Configuration and Function Descriptions	5	Higher Output Current	11
Typical Performance Characteristics	6	Constant Dropout Post Regulator	11
Theory of Operation	9	Outline Dimensions	12
Application Information	10	Ordering Guide	12

REVISION HISTORY

12/06—Rev. B to Rev. C

Change to Table 1	3
Updated Outline Dimensions	12
Changes to the Ordering Guide	12

7/04—Rev. A to Rev. B.

Changes to the Ordering Guide	3
Updated Outline Dimensions	8

12/00—Rev. 0 to Rev. A

9/98—Revision 0: Initial Version

SPECIFICATIONS

@ $T_A = -20^\circ\text{C}$ to $+85^\circ\text{C}$, $V_{IN} = 7\text{ V}$, $C_{IN} = 0.47\ \mu\text{F}$, $C_{OUT} = 0.47\ \mu\text{F}$, unless otherwise noted.¹ The following specifications apply to all voltage options.

Table 1.

Parameter	Symbol	Conditions	Min	Typ	Max	Unit
Output Voltage Accuracy	V_{OUT}	$V_{IN} = V_{OUTNOM} + 0.3\text{ V to }12\text{ V}$, $I_L = 0.1\text{ mA to }100\text{ mA}$, $T_A = 25^\circ\text{C}$	-1.2		+1.2	%
		$V_{IN} = V_{OUTNOM} + 0.3\text{ V to }12\text{ V}$, $I_L = 0.1\text{ mA to }100\text{ mA}$	-2.2		+2.2	%
Line Regulation	$\frac{\Delta V_{OUT}}{\Delta V_{IN}}$	$V_{IN} = V_{OUTNOM} + 0.3\text{ V to }12\text{ V}$, $T_A = 25^\circ\text{C}$		0.02		mV/V
Load Regulation	$\frac{\Delta V_{OUT}}{\Delta I_L}$	$I_L = 0.1\text{ mA to }100\text{ mA}$, $T_A = 25^\circ\text{C}$		0.06		mV/mA
Ground Current	I_{GND}	$I_L = 100\text{ mA}$		0.8	2.0	mA
		$I_L = 0.1\text{ mA}$		0.19	0.3	mA
Ground Current in Dropout	I_{GND}	$V_{IN} = 2.4\text{ V}$, $I_L = 0.1\text{ mA}$		0.9	1.7	mA
Dropout Voltage	$V_{DROPOUT}$	$V_{OUT} = 98\%$ of V_{OUTNOM}				
		$I_L = 100\text{ mA}$		0.12	0.25	V
		$I_L = 10\text{ mA}$		0.025	0.07	V
		$I_L = 1\text{ mA}$		0.004	0.015	V
Shutdown Threshold	V_{THSD}	On	2.0			V
		Off			0.3	V
Shutdown Pin Input Current	I_{SDIN}	$0 < V_{SD} \leq 5\text{ V}$			1	μA
		$5 < V_{SD} \leq 12\text{ V}$ @ $V_{IN} = 12\text{ V}$			9	μA
Ground Current in Shutdown Mode	I_Q	$V_{SD} = 0\text{ V}$, $V_{IN} = 12\text{ V}$, $T_A = 25^\circ\text{C}$		0.005	1	μA
		$V_{SD} = 0\text{ V}$, $V_{IN} = 12\text{ V}$, $T_A = 85^\circ\text{C}$		0.01	3	μA
Output Current in Shutdown Mode	I_{OSD}	$T_A = 25^\circ\text{C}$ @ $V_{IN} = 12\text{ V}$			2	μA
		$T_A = 85^\circ\text{C}$ @ $V_{IN} = 12\text{ V}$			4	μA
Error Pin Output Leakage	I_{EL}	$V_{EO} = 5\text{ V}$			13	μA
Error Pin Output Low Voltage	V_{EOL}	$I_{SINK} = 400\ \mu\text{A}$		0.12	0.3	V
Peak Load Current	I_{LDPK}	$V_{IN} = V_{OUTNOM} + 1\text{ V}$, $T_A = 25^\circ\text{C}$		150		mA
Output Noise @ 5 V Input	V_{NOISE}	$f = 10\text{ Hz to }100\text{ kHz}$		100		$\mu\text{V rms}$

¹ Ambient temperature of 85°C corresponds to a junction temperature of 125°C under typical full load test conditions.

ABSOLUTE MAXIMUM RATINGS

Table 2.

Parameter	Rating
Input Supply Voltage	-0.3 V to +16 V
Shutdown Input Voltage	-0.3 V to +16 V
Power Dissipation	Internally Limited
Operating Ambient Temperature Range	-55°C to +125°C
Operating Junction Temperature Range	-55°C to +125°C
θ_{JA}	190°C/W
θ_{JC}	92°C/W
Storage Temperature Range	-65°C to +150°C
Lead Temperature (Soldering 10 sec)	300°C
Vapor Phase (60 sec)	215°C
Infrared (15 sec)	220°C

Stresses above those listed under Absolute Maximum Ratings may cause permanent damage to the device. This is a stress rating only; functional operation of the device at these or any other conditions above those indicated in the operational section of this specification is not implied. Exposure to absolute maximum rating conditions for extended periods may affect device reliability.

ESD CAUTION



ESD (electrostatic discharge) sensitive device. Charged devices and circuit boards can discharge without detection. Although this product features patented or proprietary protection circuitry, damage may occur on devices subjected to high energy ESD. Therefore, proper ESD precautions should be taken to avoid performance degradation or loss of functionality.

PIN CONFIGURATION AND FUNCTION DESCRIPTIONS

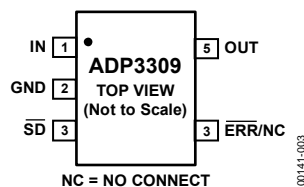

Figure 3. Pin Configuration

Table 3. Pin Function Descriptions

Pin No.	Mnemonic	Description
1	IN	Regulator Input.
2	GND	Ground Pin.
3	\overline{SD}	Active Low Shutdown Pin. Connect to ground to disable the regulator output. When shutdown is not used, this pin should be connected to the input pin.
4	$\overline{ERR/NC}$	Open Collector. Output that goes low to indicate the output is about to go out of regulation. This pin can be left open. (NC = No Connect).
5	OUT	Output of the Regulator. Fixed 2.5 V, 2.7 V, 2.85 V, 2.9 V, 3.0 V, 3.3 V, or 3.6 V output voltage. Bypass to ground with a 0.47 μ F or larger capacitor.

TYPICAL PERFORMANCE CHARACTERISTICS

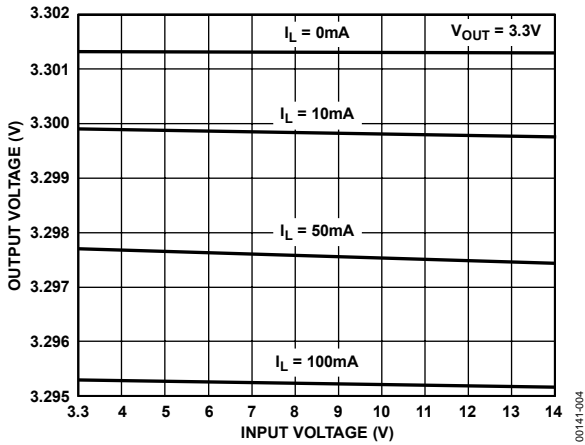

Figure 4. Line Regulation: Output Voltage vs. Supply Voltage

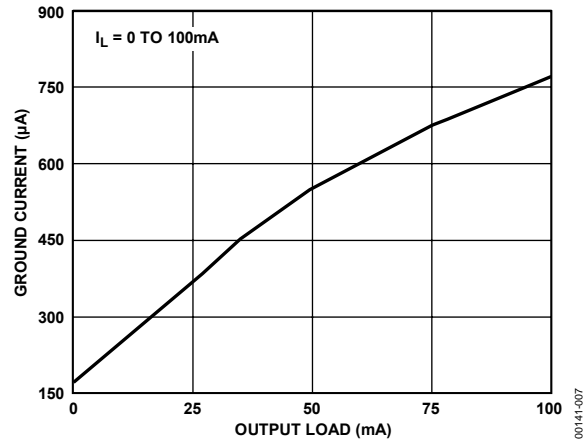

Figure 7. Quiescent Current vs. Load Current

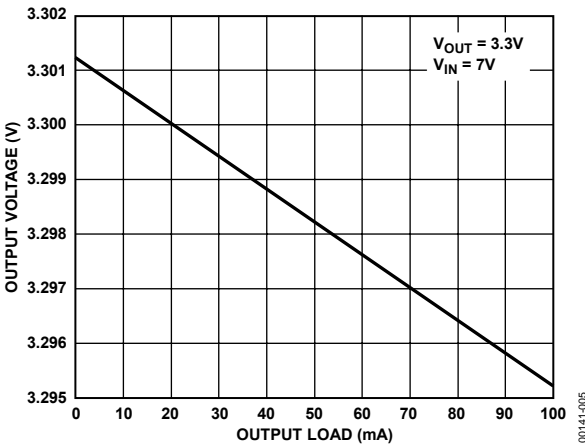

Figure 5. Output Voltage vs. Load Current

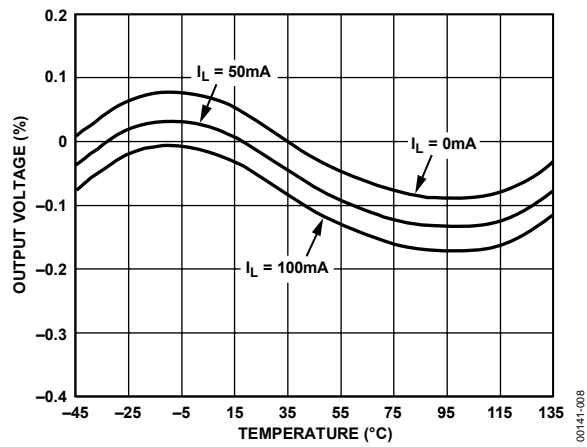

Figure 8. Output Voltage Variation % vs. Temperature

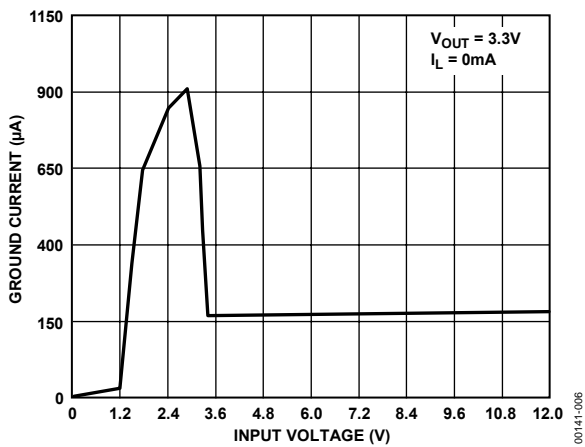

Figure 6. Quiescent Current vs. Supply Voltage

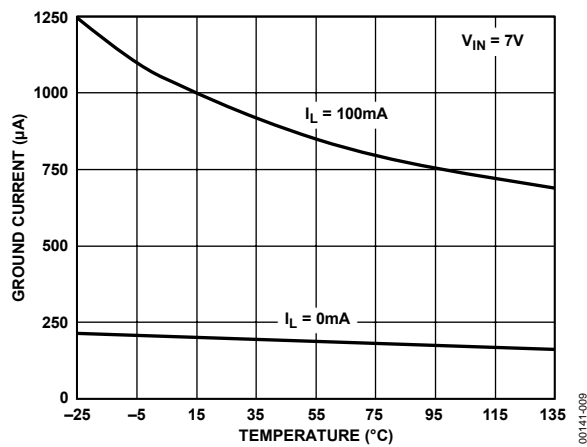

Figure 9. Quiescent Current vs. Temperature

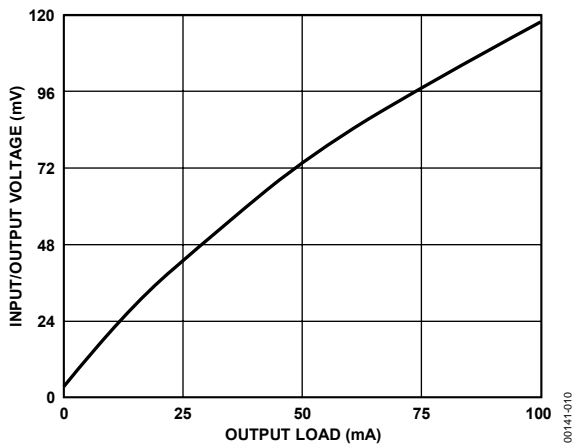

Figure 10. Dropout Voltage vs. Output Current

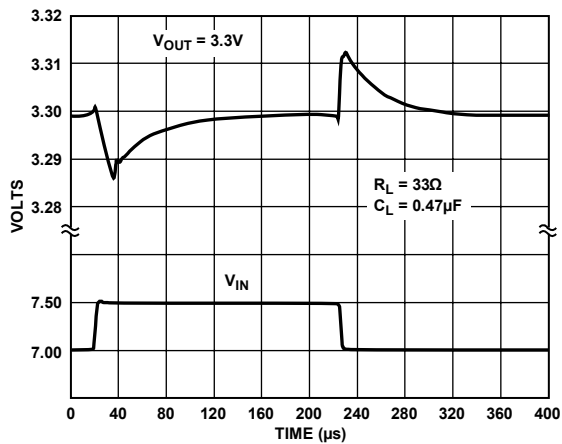

Figure 13. Line Transient Response

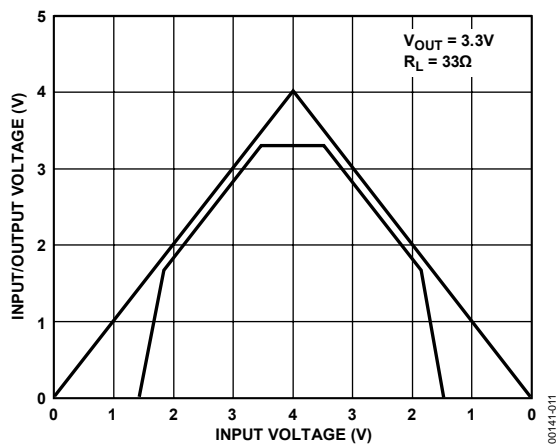

Figure 11. Power-Up/Power-Down

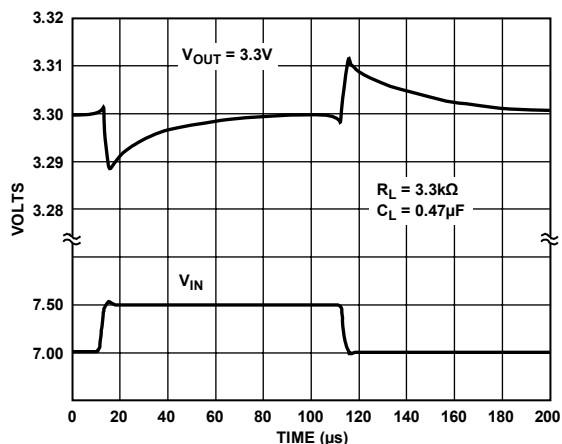

Figure 14. Line Transient Response

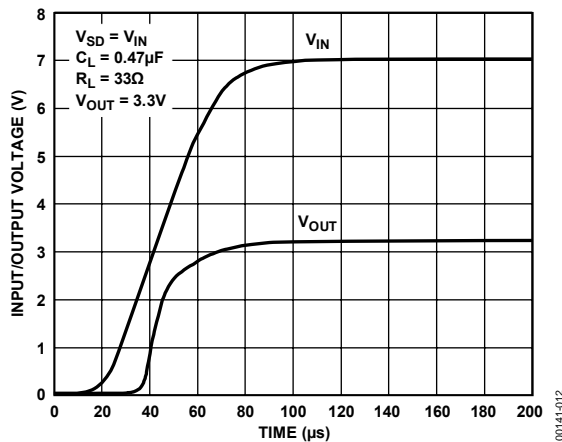

Figure 12. Power-Up Overshoot

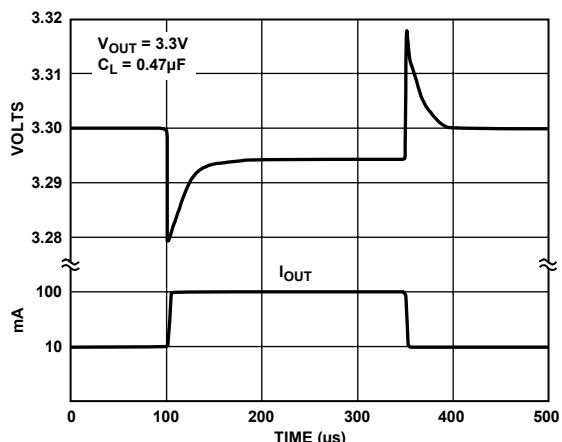

Figure 15. Load Transient

ADP3309

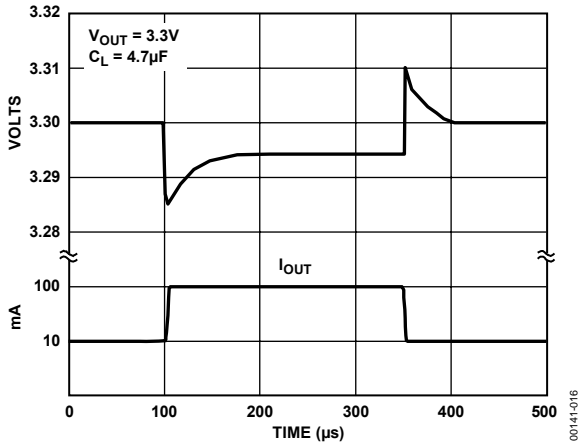

Figure 16. Load Transient

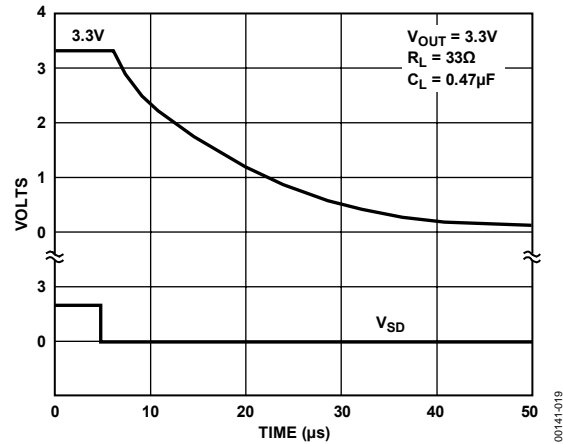

Figure 19. Turn-Off

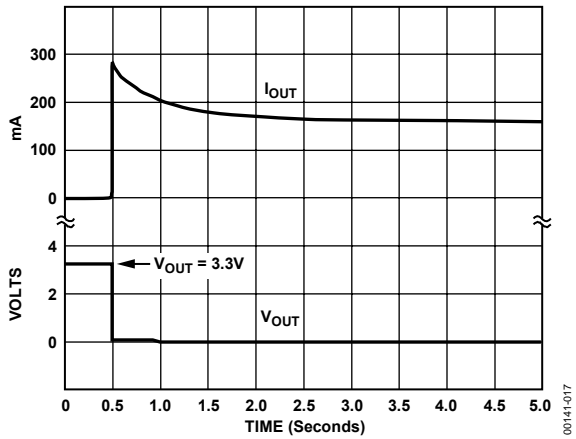

Figure 17. Short-Circuit Current

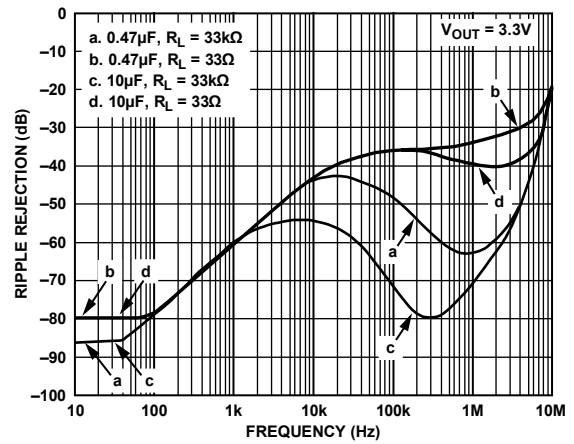

Figure 20. Power Supply Ripple Rejection

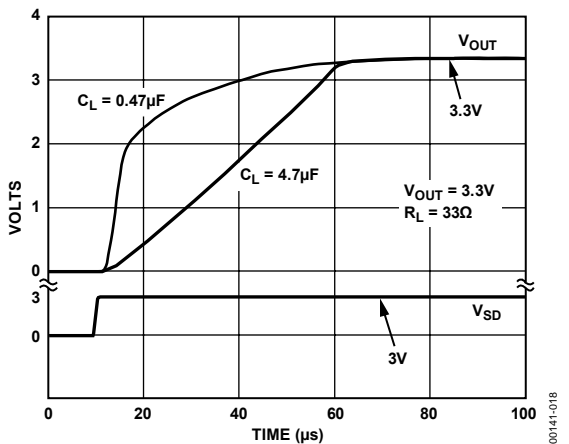

Figure 18. Turn-On

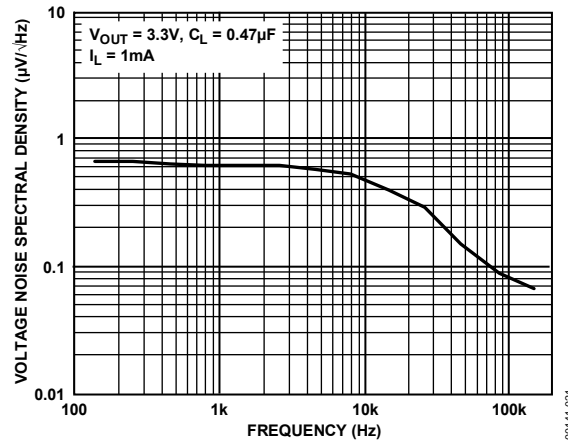

Figure 21. Output Noise Density

THEORY OF OPERATION

The ADP3309 anyCAP LDO uses a single control loop for regulation and reference functions. The output voltage is sensed by a resistive voltage divider consisting of R1 and R2, which is varied to provide the available output voltage option. Feedback is taken from this network by way of a series diode (D1) and a second resistor divider (R3 and R4) to the input of an amplifier.

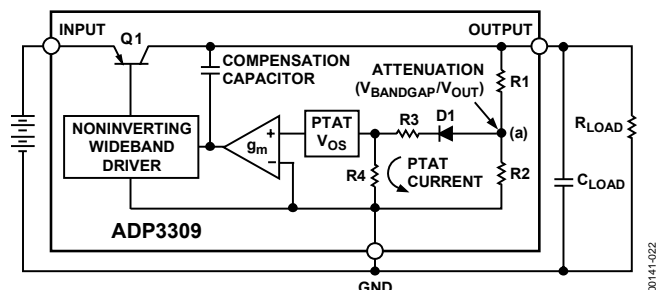

Figure 22. Functional Block Diagram

A very high gain error amplifier is used to control this loop. The amplifier is constructed in such a way that at equilibrium, it produces a large, temperature proportional input offset voltage that is repeatable and very well controlled. The temperature proportional offset voltage is combined with the complementary diode voltage to form a virtual band gap voltage, implicit in the network, although it never appears explicitly in the circuit. Ultimately, this patented design makes it possible to control the loop with only one amplifier. This technique also improves the noise characteristics of the amplifier by providing more flexibility on the trade-off of noise sources that leads to a low noise design.

The R1, R2 divider is chosen in the same ratio as the band gap voltage to the output voltage. Although the R1, R2 resistor divider is loaded by the diode (D1), and a second divider consisting of R3 and R4, the values can be chosen to produce a temperature stable output.

The patented amplifier controls a new and unique noninverting driver that drives the pass transistor (Q1). The use of this special noninverting driver enables the frequency compensation to include the load capacitor in a pole splitting arrangement to achieve reduced sensitivity to the value, type, and ESR of the load capacitance.

Most LDOs place very strict requirements on the range of ESR values for the output capacitor because they are difficult to stabilize due to the uncertainty of load capacitance and resistance. Moreover, the ESR value, required to keep conventional LDOs stable, changes depending on load and temperature. These ESR limitations make designing with LDOs more difficult because of their unclear specifications and extreme variations over temperature.

This is no longer true with the ADP3309 anyCAP LDO. It can be used with virtually any capacitor, with no constraint on the minimum ESR. This innovative design allows the circuit to be stable with just a small 0.47 μF capacitor on the output. Additional advantages of the design scheme include superior line noise rejection and very high regulator gain, which leads to excellent line, and load regulation. An impressive $\pm 2.2\%$ accuracy is guaranteed over line, load, and temperature.

Additional features of the circuit include current limit and thermal shutdown. Compared to the standard solutions that give warning after the output has lost regulation, the ADP3309 provides improved system performance by enabling the ERR pin to give warning before the device loses regulation.

As the chip's temperature rises above 165°C, the circuit activates a soft thermal shutdown, indicated by a signal low on the ERR pin, to reduce the current to a safe level.

APPLICATION INFORMATION

CAPACITOR SELECTION: anyCAP

Output Capacitors: As with any micropower device, output transient response is a function of the output capacitance. The ADP3309 is stable with a wide range of capacitor values, types, and ESR (anyCAP). A capacitor as low as 0.47 μF is all that is needed for stability. However, larger capacitors can be used if high output current surges are anticipated. The ADP3309 is stable with extremely low ESR capacitors ($\text{ESR} \approx 0$), such as multilayer ceramic capacitors (MLCC) or OSCON.

Input Bypass Capacitor: An input bypass capacitor is not required. However, for applications where the input source is high impedance or far from the input pin, a bypass capacitor is recommended. Connecting a 0.47 μF capacitor from the input pin (Pin 1) to ground reduces the circuit's sensitivity to PC board layout. If a bigger output capacitor is used, the input capacitor must be 1 μF minimum.

THERMAL OVERLOAD PROTECTION

The ADP3309 is protected against damage due to excessive power dissipation by its thermal overload protection circuit, which limits the die temperature to a maximum of 165°C. Under extreme conditions (that is, high ambient temperature and power dissipation) where die temperature starts to rise above 165°C, the output current is reduced until the die temperature has dropped to a safe level. The output current is restored when the die temperature is reduced.

Current and thermal limit protections are intended to protect the device against accidental overload conditions. For normal operation, device power dissipation should be externally limited so that junction temperatures do not exceed 125°C.

CALCULATING JUNCTION TEMPERATURE

Device power dissipation is calculated as follows:

$$P_D = (V_{IN} - V_{OUT}) I_{LOAD} + (V_{IN}) I_{GND}$$

where:

I_{LOAD} is the load current.

I_{GND} is the ground current.

V_{IN} is the input voltage.

V_{OUT} is the output voltage.

Assuming $I_{LOAD} = 100 \text{ mA}$, $I_{GND} = 2 \text{ mA}$, $V_{IN} = 5.0 \text{ V}$, and $V_{OUT} = 3.3 \text{ V}$, device power dissipation is

$$P_D = (5.0 - 3.3) 100 \text{ mA} + 5.0 \times 2 \text{ mA} = 180 \text{ mW}$$
$$\Delta T = T_J - T_A = P_D \times \theta_{JA} = 0.18 \times 190 = 34.2^\circ\text{C}$$

With a maximum junction temperature of 125°C, this yields a maximum ambient temperature of $\sim 90^\circ\text{C}$.

PRINTED CIRCUIT BOARD LAYOUT CONSIDERATION

Surface-mount components rely on the conductive traces or pads to transfer heat away from the device. Appropriate PC board layout techniques should be used to remove heat from the immediate vicinity of the package.

The following general guidelines will be helpful when designing a board layout:

1. PC board traces with larger cross section areas remove more heat. For optimum results, use PC boards with thicker copper and/or wider traces.
2. Increase the surface area exposed to open air so heat can be removed by convection or forced air flow.
3. Do not use solder mask or silk screen on the heat dissipating traces because it increases the junction to ambient thermal resistance of the package.

SHUTDOWN MODE

Applying a TTL high signal to the shutdown pin or tying it to the input pin turns the output on. Pulling the shutdown pin down to a TTL low signal or tying it to ground turns the output off. In shutdown mode, quiescent current is reduced to less than 1 μA .

ERROR FLAG DROPOUT DETECTOR

The ADP3309 maintains its output voltage over a wide range of load, input voltage, and temperature conditions. If the output is about to lose regulation, for example, by reducing the supply voltage below the combined regulated output and dropout voltages, the $\overline{\text{ERR}}$ pin will be activated. The $\overline{\text{ERR}}$ output is an open collector that will be driven low.

Once set, the $\overline{\text{ERR}}$ or flag's hysteresis keeps the output low until a small margin of operating range is restored either by raising the supply voltage or reducing the load.

APPLICATION CIRCUITS

CROSSOVER SWITCH

The circuit in Figure 23 shows that two ADP3309s can be used to form a mixed supply voltage system. The output switches between two different levels selected by an external digital input. Output voltages can be any combination of voltages from the Ordering Guide of the data sheet.

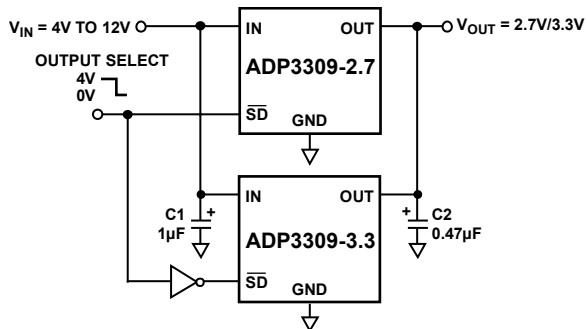
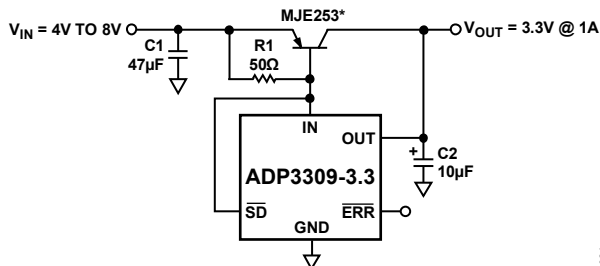

Figure 23. Crossover Switch

HIGHER OUTPUT CURRENT

The ADP3309 can source up to 100 mA without any heat sink or pass transistor. If higher current is needed, an appropriate pass transistor can be used, as in Figure 24, to increase the output current to 1 A.



*AAVID531002 HEAT SINK IS USED

Figure 24. Higher Output Current Linear Regulator

CONSTANT DROPOUT POST REGULATOR

The circuit in Figure 25 provides high precision with low dropout for any regulated output voltage. It significantly reduces the ripple from a switching regulator while providing a constant dropout voltage, which limits the power dissipation of the LDO to 30 mW. The ADP3000 used in this circuit is a switching regulator in the step-up configuration.

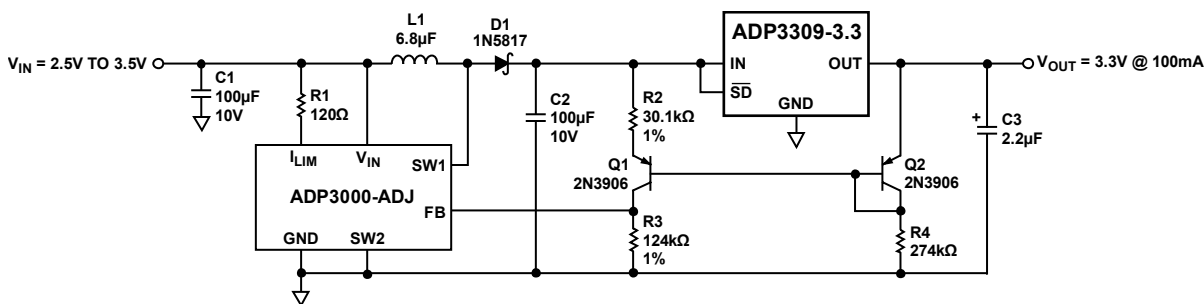
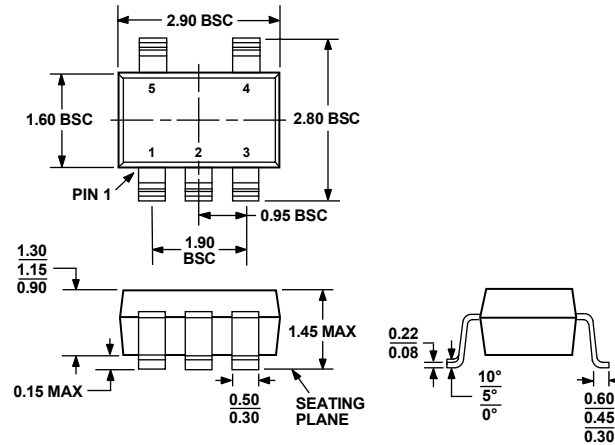

Figure 25. Constant Dropout Post Regulator

OUTLINE DIMENSIONS



COMPLIANT TO JEDEC STANDARDS MO-178-AA

Figure 26. 5-Lead Small Outline Transistor Package [SOT-23] (RJ-5)

Dimensions shown in millimeters

ORDERING GUIDE

Model	Temperature Range	Voltage Output	Package Description	Package Option	Branding
ADP3309ART-2.5-RL	-20°C to +85°C	2.5 V	5-Lead SOT-23	RJ-5	LDE
ADP3309ART-2.5-RL7	-20°C to +85°C	2.5 V	5-Lead SOT-23	RJ-5	LDE
ADP3309ARTZ-2.5RL7 ¹	-20°C to +85°C	2.5 V	5-Lead SOT-23	RJ-5	LDE#
ADP3309ART-2.7-RL	-20°C to +85°C	2.7 V	5-Lead SOT-23	RJ-5	DNC
ADP3309ART-2.7-RL7	-20°C to +85°C	2.7 V	5-Lead SOT-23	RJ-5	DNC
ADP3309ARTZ-2.7-R7 ¹	-20°C to +85°C	2.7 V	5-Lead SOT-23	RJ-5	L1P
ADP3309ART-2.85-R7	-20°C to +85°C	2.85 V	5-Lead SOT-23	RJ-5	DVC
ADP3309ART-2.85-RL	-20°C to +85°C	2.85 V	5-Lead SOT-23	RJ-5	DVC
ADP3309ARTZ-2.85R7 ¹	-20°C to +85°C	2.85 V	5-Lead SOT-23	RJ-5	L1R
ADP3309ART-2.9-RL	-20°C to +85°C	2.9 V	5-Lead SOT-23	RJ-5	DWC
ADP3309ART-2.9-RL7	-20°C to +85°C	2.9 V	5-Lead SOT-23	RJ-5	DWC
ADP3309ARTZ-2.9-R7 ¹	-20°C to +85°C	2.9 V	5-Lead SOT-23	RJ-5	L1S
ADP3309ART-3-REEL	-20°C to +85°C	3.0 V	5-Lead SOT-23	RJ-5	DPC
ADP3309ART-3-REEL7	-20°C to +85°C	3.0 V	5-Lead SOT-23	RJ-5	DPC
ADP3309ARTZ-3REEL7 ¹	-20°C to +85°C	3.0 V	5-Lead SOT-23	RJ-5	DPC#
ADP3309ART-3.3-RL	-20°C to +85°C	3.3 V	5-Lead SOT-23	RJ-5	DRC
ADP3309ART-3.3-RL7	-20°C to +85°C	3.3 V	5-Lead SOT-23	RJ-5	DRC
ADP3309ARTZ-3.3-R7 ¹	-20°C to +85°C	3.3 V	5-Lead SOT-23	RJ-5	L1Q
ADP3309ART-3.6-RL	-20°C to +85°C	3.6 V	5-Lead SOT-23	RJ-5	DTC
ADP3309ART-3.6-RL7	-20°C to +85°C	3.6 V	5-Lead SOT-23	RJ-5	DTC
ADP3309ARTZ-3.6-R7 ¹	-20°C to +85°C	3.6 V	5-Lead SOT-23	RJ-5	L1T

¹ Z = Pb-free part, # denotes lead-free product may be top or bottom marked.