

## AD ADC84/AD ADC85

### FEATURES

#### PERFORMANCE

**Complete 12-bit A/D converter with reference and clock**  
**Fast successive approximation conversion: 10  $\mu$ s or 5  $\mu$ s**  
**Buried Zener reference for long-term stability and low**

Gain TC: 10 ppm/ $^{\circ}$ C

Max nonlinearity:  $< \pm 0.012\%$

Low power: 880 mW typ

Low chip count—high reliability

Industry-standard pinout

Z models for  $\pm 12$  V operation available

MIL-STD-883B processing available

#### VERSATILITY

Negative true parallel logic outputs

Short cycle capability

Precision +6.3 V reference for external applications

### PRODUCT DESCRIPTION

The AD ADC84/AD ADC85 series devices are high speed, low cost 12-bit successive approximation analog-to-digital converters that include an internal clock, reference, and comparator. Its hybrid IC design utilizes MSI digital and linear monolithic chips in conjunction with a 12-bit monolithic DAC to provide modular performance and versatility with IC size, price, and reliability.

Important performance characteristics of the AD ADC84/AD ADC85 series include maximum linearity error of  $\pm 0.012\%$ ; gain TC below 15 ppm/ $^{\circ}$ C at 25 $^{\circ}$ C; typical power dissipation of 880 mW; and conversion time of less than 10  $\mu$ s for the 12-bit versions. Of considerable significance in severe and aerospace applications is the guaranteed performance from -55 $^{\circ}$ C to +125 $^{\circ}$ C of the AD ADC85S, which is also available with environmental screening. Monotonic operation of the feedback DAC guarantees no missing codes over temperature ranges of 0 $^{\circ}$ C to +70 $^{\circ}$ C, -25 $^{\circ}$ C to +85 $^{\circ}$ C, and -55 $^{\circ}$ C to +125 $^{\circ}$ C.

The design of the AD ADC84/AD ADC85 includes scaling resistors that provide analog input signal ranges of  $\pm 2.5$  V,  $\pm 5$  V,  $\pm 10$  V, 0 V to +5 V, or 0 V to +10 V. The 6.3 V precision reference, which can be used for external applications, and the input buffer amplifier add flexibility and value. All digital signals are fully DTL and TTL compatible, and the data output is negative-true and available in parallel form.

The AD ADC84/AD ADC85 are available in a performance grade specified for 12-bit accuracy ( $\pm 0.012\%$  FSR max) with 10  $\mu$ s maximum conversion time.

#### Rev. B

Information furnished by Analog Devices is believed to be accurate and reliable. However, no responsibility is assumed by Analog Devices for its use, nor for any infringements of patents or other rights of third parties that may result from its use. Specifications subject to change without notice. No license is granted by implication or otherwise under any patent or patent rights of Analog Devices. Trademarks and registered trademarks are the property of their respective owners.

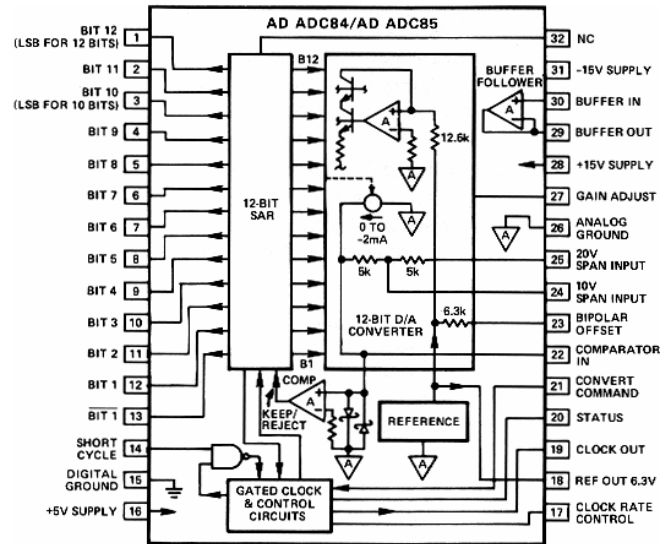

Figure 1. Functional Block Diagram

The AD ADC84 and AD ADC85C are specified for operation over the 0 $^{\circ}$ C to +70 $^{\circ}$ C temperature range. The AD ADC85 and AD ADC85S are specified for the -25 $^{\circ}$ C to +85 $^{\circ}$ C and -55 $^{\circ}$ C to +125 $^{\circ}$ C ranges, respectively. The serial output function is no longer supported on the AD ADC84/AD ADC85 after date code 9623.

### PRODUCT HIGHLIGHTS

1. The AD ADC84/AD ADC85 series devices are complete 12-bit ADCs. No external components are required to perform a conversion.
2. The AD ADC84/AD ADC85 directly replaces other devices of this type with significant increases in performance.
3. The fast conversion rates of the AD ADC84 and AD ADC85 (10  $\mu$ s) make them an excellent choice for applications requiring high system throughput rates.
4. The internal buried Zener reference is laser trimmed to 6.3 V  $\pm 0.1\%$  and  $\pm 10$  ppm/ $^{\circ}$ C typical TC. The reference is available externally and can provide up to 1 mA.
5. The integrated package construction provides high quality and reliability with small size and weight.
6. The monolithic 12-bit feedback DAC is used for reduced chip count and higher reliability.
7. The AD ADC85S/883B comes processed to MIL-STD-883, Class B requirements.

## TABLE OF CONTENTS

Specifications.....	3	Input Scaling .....	8
Typical Performance Characteristics .....	5	Input Voltage Range and LSB Values .....	8
Functional Description .....	6	Calibration.....	9
Offset Adjustment .....	6	Grounding.....	9
Gain Adjustment.....	6	Clock Rate Control Alternate Connections .....	10
Theory of Operation .....	6	Microprocessor Interfacing.....	10
Timing.....	6	Outline Dimensions .....	11
Digital Output Data .....	7	Ordering Guide .....	11

## REVISION HISTORY

### Revision B

#### 11/03—Data Sheet changed from Rev. A to Rev. B

Removed AD5240.....	Universal
Updated format.....	Universal
Added text to PRODUCT DESCRIPTION .....	1
Updated OUTLINE DIMENSIONS .....	11

## SPECIFICATIONS

Table 1. Typical @ 25°C, ±15 V and +5 V, unless otherwise noted

Model	AD ADC84	AD ADC85C	AD ADC85	AD ADC85S	Unit
RESOLUTION	12	12	12	12	Bits
ANALOG INPUTS					
Voltage Ranges					
Bipolar	±2.5, ±5, ±10	*	*	*	V
Unipolar	0 to +5, 0 to +10	*	*	*	V
Impedance (Direct Input)					
0 V to +5 V, ±2.5 V	2.5 (±20%)	*	*	*	kΩ
0 V to +10 V, ±5 V	5 (±20%)	*	*	*	kΩ
±10 V	10 (±20%)	*	*	*	kΩ
Buffer Amplifier <sup>1</sup>					
Impedance (Min)	100	*	*	*	MΩ
Bias Current	50	*	*	*	nA
Settling Time to 0.01% for 20 V Step	2	*	*	*	μs
DIGITAL INPUTS <sup>2</sup>					
Convert Command	Positive Pulse 100 ns Min Trailing Edge Initiates Conversion	*	*	*	
Logic Loading	1	*	*	*	TTL Load
TRANSFER CHARACTERISTICS ERROR					
Gain Error <sup>3</sup>	±0.1 (±0.25% max)	*	*	*	%
Offset Error	Adjustable to Zero	*	*	*	
Unipolar	±0.05 (±0.2% max)	*	*	*	% of FSR <sup>4</sup>
Bipolar <sup>5</sup>	±0.1 (±0.25% max)	*	*	*	% of FSR
Linearity Error (max) <sup>6</sup>	±0.012	*	*	*	% of FSR
Inherent Quantization Error	±0.5	*	*	*	LSB
Differential Linearity Error	±0.5	*	*	*	LSB
No Missing Codes					
Temperature Range	0 to +70	0 to +70	-25 to +85	-55 to +125	°C
Power Supply Sensitivity					
±15 V	±0.004	*	*	*	% of FSR/% V
+5 V	±0.001	*	*	*	% of FSR/% V
DRIFT					
Specification Temperature Range	0 to +70	*	-25 to +85	-55 to +125	°C
Gain (Max)	±30	±25	±15	±25	ppm/°C
Offset					
Unipolar	±3	*	*	±5 max	ppm/°C
Bipolar (Max)	±15	±12	±7	±10	ppm/°C
Linearity	±3	*	±2	*	ppm/°C
Monotonicity	Guaranteed	*	*	*	
CONVERSION SPEED (MAX)	10	*	*	*	μs

# AD ADC84/AD ADC85

Model	AD ADC84	AD ADC85C	AD ADC85	AD ADC85S	Unit
DIGITAL OUTPUT (All Codes Complementary)					
Parallel					
Output Codes <sup>7</sup>					
Unipolar	CSB	*	*	*	
Bipolar	COB, CTC	*	*	*	
Output Drive	2	*	*	*	TTL Loads
Status	Logic 1 during Conversion	*	*	*	
Status Output Drive	2	*	*	*	TTL Loads
Internal Clock					
Clock Output Drive	2	*	*	*	TTL Loads
Frequency	1.9/1.22	*	*	*	MHz
INTERNAL REFERENCE VOLTAGE	6.3/±15 mV max	*	*	*	V
Maximum External Current (with No Degradation of Specifications)	1.0	*	*	*	mA
Tempco of Drift (Max)	±20 max	±10 typ	±5 typ	±5 typ	ppm/°C
POWER REQUIREMENTS					
Rated Voltages	+5, ±15	*	*	*	V
Range for Rated Accuracy	+4.75 to +5.25 and ±13.5 to -16.5	*	*	*	V
Z Models <sup>8</sup>	+4.75 to +5.25 and ±11.4 to -16.5	*	*	*	V
Supply Drain					
+15 V	25 Max	*	*	*	mA
-15 V	35 Max	*	*	*	mA
+5 V	140 Max	*	*	*	mA
Total Power Dissipation	1500 Max	*	*	*	mW
TEMPERATURE RANGE					
Specification	0 to +70	*	-25 to +85	-55 to +125	°C
Operating (Derated Specs)	-25 to +85	*	-55 to +125	-55 to +125	°C
Storage	-55 to +125	*	*	*	°C
PACKAGE OPTION <sup>9</sup>					
DH-32F	Ceramic	Ceramic	Ceramic	Ceramic	

\*Specifications same as AD ADC84.

<sup>1</sup> Buffer settling time adds to conversion speed when buffer is connected to input.

<sup>2</sup> DTL/TTL compatible Logic 0 = 0.8 V max, Logic 1 = 2.0 V min for digital output, Logic 0 = 0.4 V max, Logic 1 = 2.4 V min.

<sup>3</sup> Adjustable to zero.

<sup>4</sup> FSR means full-scale range.

<sup>5</sup> Guaranteed at VIN = 0 V.

<sup>6</sup> Error shown is the same as ±1/2 LSB max error in % of FSR.

<sup>7</sup> See Table 2.

<sup>8</sup> For ±12 V operation, add Z to model number. Input range limited to a maximum of ±5 V.

<sup>9</sup> For package outline information, see Outline Dimensions section.

TYPICAL PERFORMANCE CHARACTERISTICS

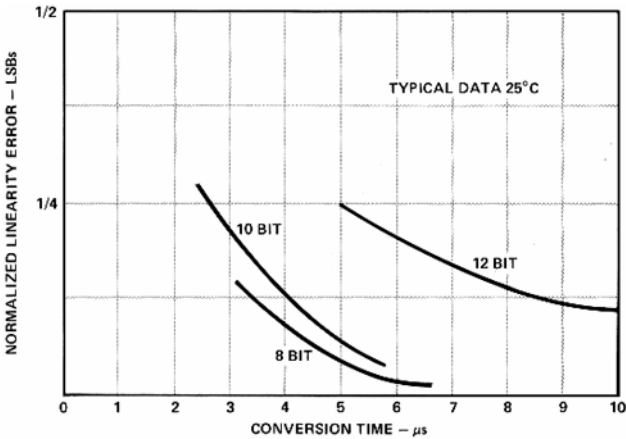

Figure 2. Linearity Error vs. Conversion Speed

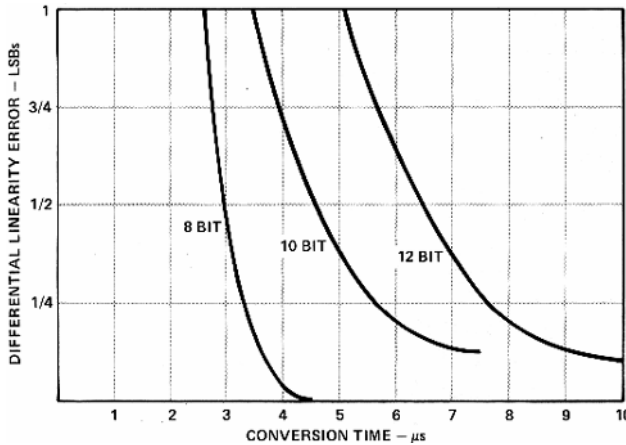

Figure 4. Change in Differential Linearity vs. Conversion Speed

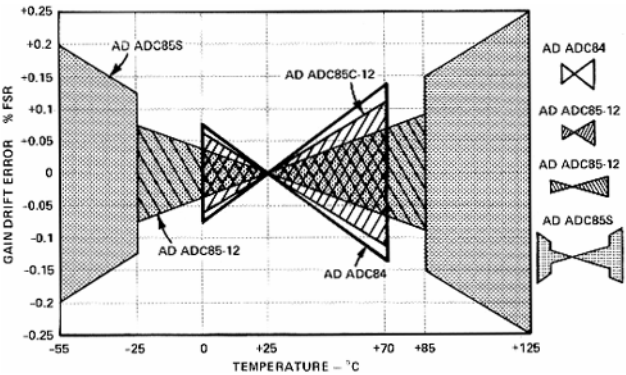

Figure 3. Gain Drift Error (%FSR) vs. Temperature

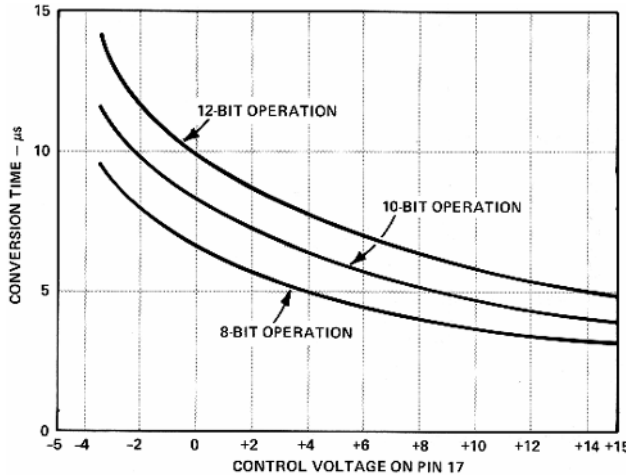

Figure 5. Conversion Speed vs. Control Voltage

## FUNCTIONAL DESCRIPTION

### OFFSET ADJUSTMENT

The zero adjust circuit consists of a potentiometer connected across  $\pm V_s$  with its slider connected through a 1.8 M $\Omega$  resistor to Comparator Input Pin 22 for all ranges. As shown in Figure 6, the tolerance of this fixed resistor is not critical, and a carbon composition type is generally adequate. Using a carbon composition resistor having a  $-1200$  ppm/ $^{\circ}\text{C}$  tempco contributes a worst-case offset tempco of  $8 \times 244 \times 10^{-6} \times 1200$  ppm/ $^{\circ}\text{C} = 2.3$  ppm/ $^{\circ}\text{C}$  of FSR, if the OFFSET ADJ potentiometer is set at either end of its adjustment range. Since the maximum offset adjustment required is typically no more than  $\pm 4$  LSB, use of a carbon composition offset summing resistor typically contributes no more than 1 ppm/ $^{\circ}\text{C}$  of FSR offset tempco.

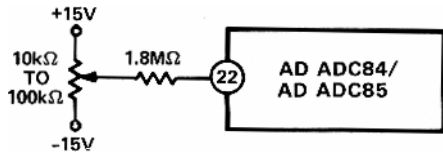

Figure 6. Offset Adjustment Circuit

An alternate offset adjust circuit, which contributes negligible offset tempco if metal film resistors (tempco  $< 100$  ppm/ $^{\circ}\text{C}$ ) are used, is shown in Figure 7.

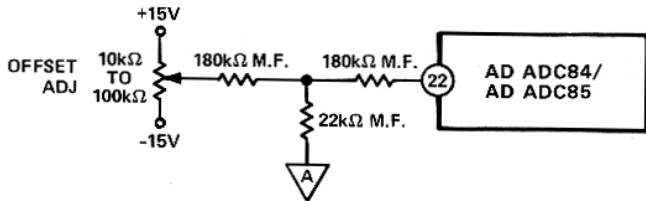

Figure 7. Low Tempco Zero Adjustment Circuit

In either zero adjust circuit, the fixed resistor connected to Pin 22 should be located close to this pin to keep the pin connection runs short. (Comparator Input Pin 22 is quite sensitive to external noise pickup).

### GAIN ADJUSTMENT

The gain adjust circuit consists of a potentiometer connected across  $\pm V_s$  with its slider connected through a 10M $\Omega$  resistor to the Gain Adjust pin 27 as shown in Figure 8.

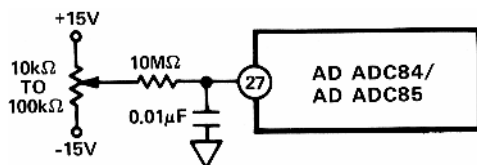

Figure 8. Gain Adjustment Circuit

An alternate gain adjust circuit which contributes negligible gain tempco if metal film resistors (Tempco  $< 100$  ppm/ $^{\circ}\text{C}$ ) are used is shown in Figure 9.

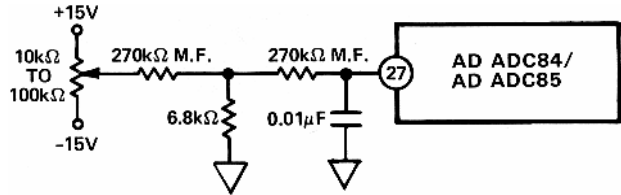

Figure 9. Low Tempco Gain Adjustment Circuit

### THEORY OF OPERATION

On receipt of a CONVERT START command, the AD ADC84/AD ADC85 converts the voltage as its analog input into an equivalent 12-bit binary number. This conversion is accomplished as follows: The 12-bit successive approximation register (SAR) has its 12-bit outputs connected both to the device bit output pins and to the corresponding bit inputs of the feedback DAC. The analog input is successively compared to the feedback DAC output, one bit at a time (MSB first, LSB last). The decision to keep or reject each bit is then made at the completion of each bit comparison period, depending on the state of the comparator at that time.

### TIMING

The timing diagram is shown in Figure 10. Receipt of a CONVERT START signal sets the STATUS flag, indicating conversion in progress. This, in turn, removes the inhibit applied to the gated clock, permitting it to run through 13 cycles. All the SAR parallel bits, STATUS flip-flops, and the gated clock inhibit signal are initialized on the trailing edge of the CONVERT START signal. At time  $t_0$ , Bit 1 is reset and Bit 2 to Bit 12 are set unconditionally. At  $t_1$ , the Bit 1 decision is made (keep) and Bit 2 is unconditionally reset. At  $t_2$ , the Bit 2 decision is made (keep) and Bit 3 is reset unconditionally. This sequence continues until the Bit 12 (LSB) decision (keep) is made at  $t_{12}$ . After a 40 ns delay period, the STATUS flag is reset, indicating that the conversion is complete and that the parallel output data is valid. Resetting the STATUS flag restores the gated clock inhibit signal, forcing the clock output to the Logic 0 state.

Corresponding parallel data bits become valid on the same positive-going clock edge (see Figure 10).

Incorporation of the 40ns delay guarantees that the parallel data is valid at the Logic 1 to 0 transition of the STATUS flag, permitting parallel data transfer to be initiated by the trailing edge of the STATUS signal.

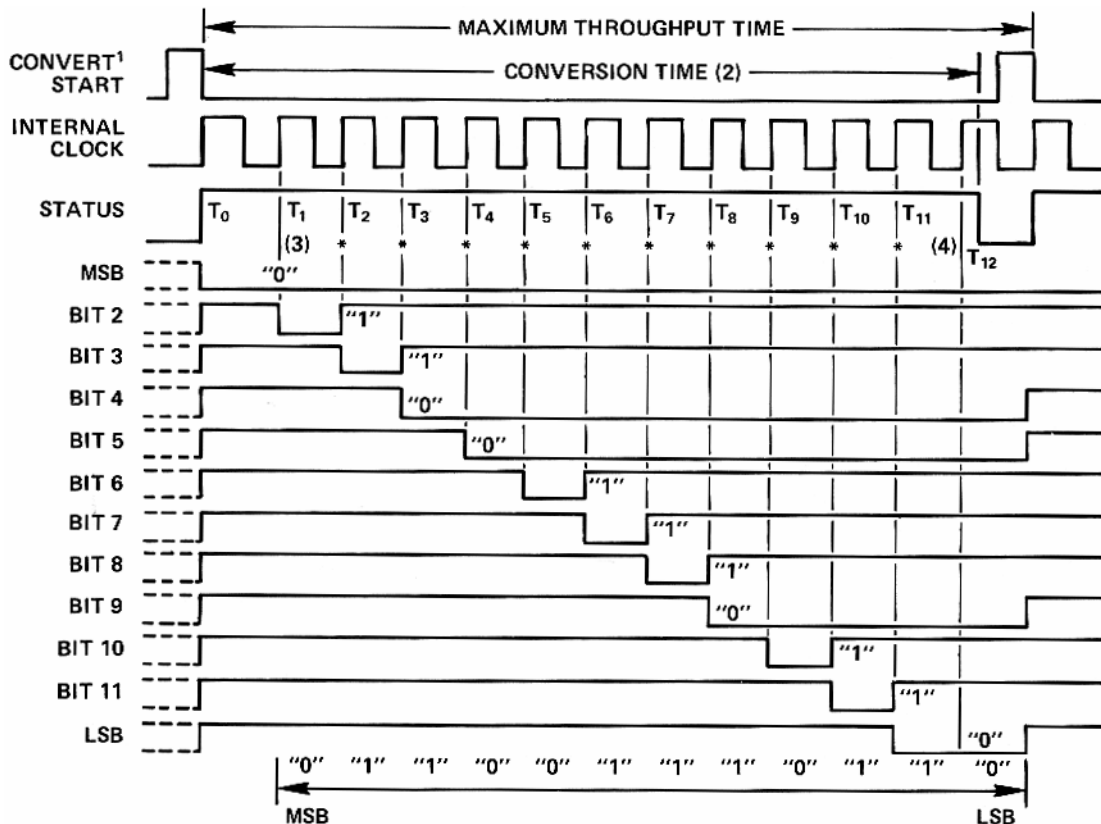

## NOTES

1. THE CONVERT START PULSE WIDTH IS 100ns MIN AND MUST REMAIN LOW DURING A CONVERSION. THE CONVERSION IS INITIATED BY THE "TRAILING EDGE" OF THE CONVERT COMMAND.
  2. 10 $\mu$ s FOR 12 BITS (AD ADC84/AD ADC85).
  3. MSB DECISION.
  4. LSB DECISION 20ns PRIOR TO THE STATUS GOING LOW.
- \*BIT DECISIONS.

Figure 10. Timing Diagram (Binary Code 011001110110)

## DIGITAL OUTPUT DATA

Parallel data from TTL storage registers are in negative true form. Parallel data coding is complementary binary for unipolar ranges and either complementary offset binary or complementary twos complement binary, depending on whether BIT 1 (Pin 12) or its logical inverse BIT 1 (Pin 13) is used as the MSB. Parallel data becomes valid approximately 40 ns before the STATUS flag returns to Logic "0", permitting parallel data transfer to be clocked on the "1" to "0" transition of the STATUS flag.

Parallel data outputs change state on positive-going clock edges. There are 13 negative-going clock edges in the complete 12-bit conversion cycle, as shown in Figure 10. The first edge shifts an invalid bit into the register, which is shifted out on the 13th negative-going clock edge.

## Short Cycle Input

A short cycle input, Pin 14, permits the timing cycle shown in Figure 10 to be terminated after any number of desired bits has been converted, permitting somewhat shorter conversion times in applications not requiring full 12-bit resolution. When 12-bit resolution is required, Pin 14 is connected to +5 V (Pin 16). When 10-bit resolution is required, Pin 14 is connected to Bit 11 output Pin 2. The conversion cycle then terminates, and the STATUS flag resets after the Bit 10 decision ( $t_{10} + 40$  ns in timing diagram of Figure 10). Short cycle pin connections and associated maximum 12-, 10-, and 8-bit conversion times are summarized in Table 2.

# AD ADC84/AD ADC85

## INPUT SCALING

The AD ADC84/AD ADC85 inputs should be scaled as close to the maximum input signal range as possible in order to utilize the maximum signal resolution of the A/D converter. Connect the input signal as shown in Table 3. See Figure 11 for circuit detail.

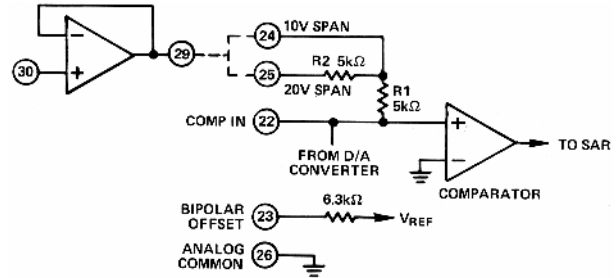

Figure 11. Input Scaling Circuit

Table 2. Short Cycle Connections

Connect Short Cycle Pin 14 to Pin	Connect Clock Rate Control Pin 17 to Pin	Bits	Resolution (% FSR)	AD ADC84/AD ADC85 Conversion Time ( $\mu$ s)	Status Flag Reset
16	15	12	0.024	10 (5)	$t_{12} + 40$ ns
2	16	10	0.100	8.5 (4.1)	$t_{10} + 40$ ns
4	28	8	0.390	6.8 (3.3)	$t_8 + 40$ ns

Table 3. Input Scaling Connections

Input Signal Range	Output Code	Connect Pin 23 to Pin	Connect Pin 25 to	For Direct Input Connect Input Signal to Pin	Input Pin 30 Connect Pin 29 to Pin
$\pm 10$ V	COB or CTC	22	Input Signal	25	25
$\pm 5$ V	COB or CTC	22	Open	24	24
$\pm 2.5$ V	COB or CTC	22	Pin 22	24	24
0 V to +5 V	CSB	26	Pin 22	24	24
0 V to +10 V	CSB	26	Open	24	24

## INPUT VOLTAGE RANGE AND LSB VALUES

Table 4. Input Voltages and Code Definition

Analog Input Voltage Range		$\pm 10$ V	$\pm 5$ V	$\pm 2.5$ V	0 V to +10 V	0 V to +5 V
Code Designation		COB <sup>1</sup> or CTC <sup>2</sup>	COB or CTC	COB or CTC	CSB <sup>3</sup>	CSB
One Least Significant Bit (LSB)	$\frac{FSR}{2^n}$	$\frac{20V}{2^n}$	$\frac{10V}{2^n}$	$\frac{5V}{2^n}$	$\frac{10V}{2^n}$	$\frac{5V}{2^n}$
	n = 8	78.13 mV	39.06 mV	19.53 mV	39.06 mV	19.53 mV
	n = 10	19.53 mV	9.77 mV	4.88 mV	9.77 mV	4.88 mV
	n = 12	4.88 mV	2.44 mV	1.22 mV	2.44 mV	1.22 mV
Transition Values						
MSB	LSB					
000 ... 000 <sup>4</sup>	+Full Scale	+10 V -3/2 LSB	+5 V -3/2 LSB	+2.5 -3/2 LSB	+10 V -3/2 LSB	+5 V -3/2 LSB
011 ... 111	Mid Scale	0	0	0	+5 V	+2.5 V
111 ... 110	-Full Scale	-10 V +1/2 LSB	-5 V +1/2 LSB	-2.5 V +1/2 LSB	0 V +1/2 LSB	0 V +1/2 LSB

<sup>1</sup> COB = Complementary Offset Binary.

<sup>2</sup> CTC = Complementary Twos Complement – obtained by using the complement of the most significant bit ( $\overline{MSB}$ ).  $\overline{MSB}$  is available to Pin 13.

<sup>3</sup> CSB = Complementary Straight Binary.

<sup>4</sup> Voltages given are the nominal value for transition to the code specified.







## OUTLINE DIMENSIONS

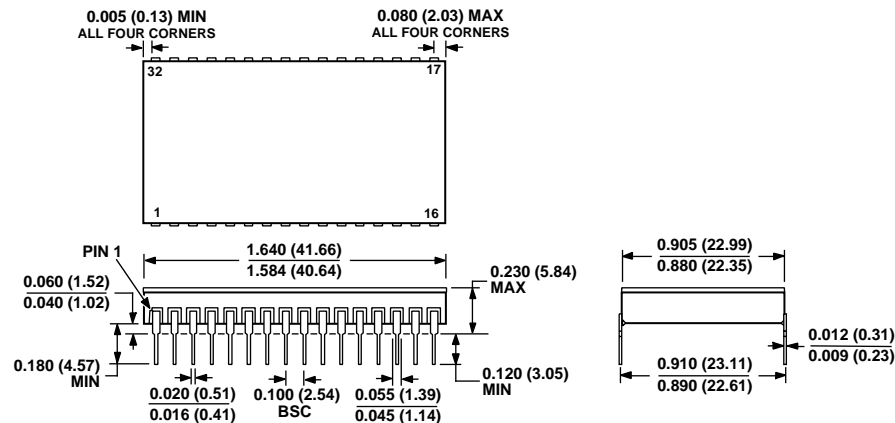

CONTROLLING DIMENSIONS ARE IN INCHES; MILLIMETER DIMENSIONS (IN PARENTHESES) ARE ROUNDED-OFF INCH EQUIVALENTS FOR REFERENCE ONLY AND ARE NOT APPROPRIATE FOR USE IN DESIGN

Figure 17. 32-Lead Side Brazed Ceramic DIP [SBDIP/H] (DH-32F)

### ESD CAUTION

ESD (electrostatic discharge) sensitive device. Electrostatic charges as high as 4000 V readily accumulate on the human body and test equipment and can discharge without detection. Although this product features proprietary ESD protection circuitry, permanent damage may occur on devices subjected to high energy electrostatic discharges. Therefore, proper ESD precautions are recommended to avoid performance degradation or loss of functionality.



### ORDERING GUIDE

Model <sup>1</sup>	Operation Voltage (V)	Linearity (%)	Temperature Range	Gain TC (ppm/°C)	Conversion Time (μs)
ADADC84-12 <sup>2</sup>	±15	±0.012	0°C to +70°C	±30	10
ADADC84Z-12 <sup>2</sup>	±12	±0.012	0°C to +70°C	±30	10
ADADC85C-12 <sup>2</sup>	±15	±0.012	0°C to +70°C	±25	10
ADADC85-12	±15	±0.012	-25°C to +85°C	±15	10
ADADC85Z-12 <sup>2</sup>	±12	±0.012	-25°C to +85°C	±15	10
ADADC85S-12	±15	±0.012	-55°C to +125°C	±25	10
ADADC85SZ-12	±12	±0.012	-55°C to +125°C	±25	10
ADADC85S12/883B	±15	±0.012	-55°C to +125°C	±25	10
ADADC85SZ12/883	±12	±0.012	-55°C to +125°C	±25	10

<sup>1</sup> For complete model number, suffixes must be added for "Z" option (±12 V operation), linearity. The following guide shows the proper suffix order: AD ADC(\*)(\*\*)-(\*\*\*), where \* = Model Number, \*\* = Z Version Designator, and \*\*\* = Linearity.  
Typical Part Numbers: AD ADC84-12, AD ADC85SZ-12.

<sup>2</sup> Last Time Buy.

**NOTES**