

FEATURES

- Up to 400 MSPS sample rate
- SNR of 63 dBFS @128 MHz
- SFDR of 70 dBFS @128 MHz
- VSWR of 1:1.5
- High or low gain grades
- Wideband ac-coupled input signal conditioning
- Enhanced spurious-free dynamic range
- Single-ended or differential ENCODE signal
- LVDS output levels
- Twos complement output data

APPLICATIONS

- Communications test equipment
- Radar and satellite subsystems
- Phased array antennas, digital beams
- Multichannel, multimode receivers
- Secure communications
- Wireless and wired broadband communications
- Wideband carrier frequency systems

GENERAL DESCRIPTION

The AD12401 is a 12-bit analog-to-digital converter (ADC) with a transformer-coupled analog input and digital post-processing for enhanced SFDR. The product operates at up to 400 MSPS conversion rate with outstanding dynamic performance in wideband carrier systems.

The AD12401 requires a 3.7 V analog supply and 3.3 V and 1.5 V digital supplies, and provides a flexible ENCODE signal that can be differential or single ended. No external reference is required.

The AD12401 package style is an enclosed 2.9" × 2.6" × 0.6" module. Performance is rated over a 0°C to 60°C case temperature range.

FUNCTIONAL BLOCK DIAGRAM

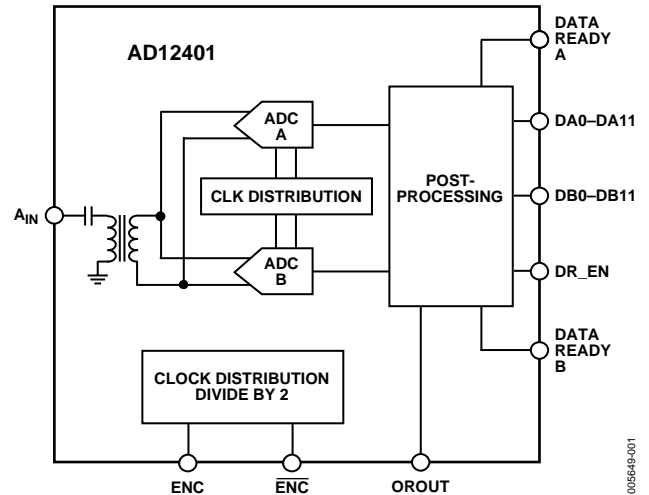

Figure 1.

PRODUCT HIGHLIGHTS

1. Guaranteed sample rate up to 400 MSPS.
2. Input signal conditioning with optimized dynamic performance to 175 MHz.
3. High and low gain grades available.
4. Additional performance options available (sample rates >400 MSPS or second Nyquist zone operation); contact sales.
5. Proprietary Advanced Filter Bank (AFB™) digital post-processing from V Corp Technologies, Inc.

Rev. A

Information furnished by Analog Devices is believed to be accurate and reliable. However, no responsibility is assumed by Analog Devices for its use, nor for any infringements of patents or other rights of third parties that may result from its use. Specifications subject to change without notice. No license is granted by implication or otherwise under any patent or patent rights of Analog Devices. Trademarks and registered trademarks are the property of their respective owners.

TABLE OF CONTENTS

Features	1	Time-Interleaving ADCs.....	18
Applications.....	1	Analog Input	18
Functional Block Diagram	1	Clock Input.....	18
General Description	1	Digital Outputs	19
Product Highlights	1	Power Supplies.....	19
Revision History	2	Start-Up and $\overline{\text{RESET}}$	19
Specifications.....	3	DR_EN.....	19
DC Specifications	3	Overrange.....	19
AC Specifications—ENCODE = 400 MSPS.....	4	Gain Select.....	20
AC Specifications—ENCODE = 360 MSPS.....	5	Thermal Considerations.....	20
AC Specifications—ENCODE = 326 MSPS.....	6	Package Integrity/Mounting Guidelines	20
Absolute Maximum Ratings.....	8	AD12401 Evaluation Kit	21
Explanation of Test Levels.....	8	Data Outputs.....	21
ESD Caution.....	8	Layout Guidelines.....	26
Pin Configuration and Function Descriptions.....	10	PCB Interface	26
Terminology	13	Outline Dimensions	28
Typical Performance Characteristics	15	Ordering Guide	28
Theory of Operation	18		

REVISION HISTORY

4/06—Rev. 0 to Rev. A

Changes to Features and Product Highlights	1
Changes to Table 1.....	3
Changes to Table 2.....	4
Changes to Table 4.....	6
Changes to Table 7.....	9
Changes to Figure 5.....	10
Changes to Table 9.....	11
Added Gain Select Section	20
Added H/L_GAIN Section.....	21
Changes to Figure 25.....	23
Changes to the Ordering Guide.....	28

7/05—Revision 0: Initial Version

SPECIFICATIONS

DC SPECIFICATIONS

VA = 3.7 V, VC = 3.3 V, VD = 1.5 V, 0°C ≤ T_{CASE} ≤ 60°C, unless otherwise noted.

Table 1.

Parameter	Case Temp	Test Level	AD12401-xxxKWS			AD12401-xxxJWS			Unit
			Min	Typ	Max	Min	Typ	Max	
RESOLUTION			12						Bits
ACCURACY			Guaranteed						
No Missing Codes	Full	IV							
Offset Error	Full	I	-12		+12	-12		+12	LSB
Gain Error @ 10 MHz	Full	I	-10		+10	-10		+10	%FS
Differential Nonlinearity (DNL)	60°C	V		±0.3			±0.3		LSB
Integral Nonlinearity (INL)	60°C	V		±0.5			±0.5		LSB
TEMPERATURE DRIFT									
Gain Error	60°C	V		0.02			0.02		%/°C
ANALOG INPUT (AIN)									
Full-Scale Input Voltage Range	60°C	V		3.2			1.6		V p-p
Flatness (10 MHz to 175 MHz)	Full	IV		0.5	1		0.5	1	dB
Input VSWR, 50 Ω (300 kHz to 175 MHz)	60°C	V		1.5			1.5		
Analog Input Bandwidth	60°C	V		480			480		MHz
POWER SUPPLY ¹									
Supply Voltage									
VA	Full	IV	3.6		3.8	3.6		3.8	V
VC	Full	IV	3.2		3.4	3.2		3.4	V
VD	Full	IV	1.45		1.55	1.45		1.55	V
Supply Current									
I _{VA} (VA = 3.7 V)	Full	I		0.95	1.2		0.95	1.2	A
I _{VC} (VC = 3.3 V)	Full	I		400	500		400	500	mA
I _{VD} (VD = 1.5 V)	Full	I		0.8	1.2		0.8	1.2	A
Total Power Dissipation	Full	I		5.7	6.8		5.7	6.8	W
ENCODE INPUTS									
Differential Inputs (ENC, $\overline{\text{ENC}}$)									
Input Voltage	Full	IV	0.4			0.4			V
Input Resistance	60°C	V		100			100		Ω
Input Capacitance	60°C	V		35			35		pF
Common-Mode Voltage	60°C	V		±3			±3		V
Single-Ended Inputs (ENC)									
Input Voltage	Full	IV	0.4		2	0.4		2	V p-p
Input Resistance	60°C	V		50			50		Ω
LOGIC INPUTS ($\overline{\text{RESET}}$) ²									
Logic 1 Voltage	Full	IV	2.0			2.0			V
Logic 0 Voltage	Full	IV			0.8			0.8	V
Source I _{IH}	60°C	IV		3.4	6		3.4	6	mA
Sink I _{IL}	60°C	IV		0.9	1		0.9	1	mA
LOGIC INPUTS (DR_EN)									
Logic 1 Voltage	Full	IV	1.7			1.7			V
Logic 0 Voltage	Full	IV			0.7			0.7	V
Source I _{IH}	60°C	IV		20	50		20	50	μA
Sink I _{IL}	60°C	IV		30	160		30	160	μA

AD12401

Parameter	Case Temp	Test Level	AD12401-xxxKWS			AD12401-xxxJWS			Unit
			Min	Typ	Max	Min	Typ	Max	
LOGIC OUTPUTS (DRA, DRB, OUTPUT BITS) ³									
Differential Output Voltage	Full	IV	247	350	454	247	350	454	mV
Output Common-Mode Voltage	Full	IV	1.125	1.25	1.375	1.125	1.25	1.375	V
Output High Voltage	60°C	IV			1.602			1.602	V
Output Low Voltage	60°C	IV	0.898			0.898			V

¹ Tested using input frequency of 70 MHz (see Figure 17).

² Refer to Table 8 for logic convention on all logic inputs.

³ Digital output logic levels: VC = 3.3 V, C_{LOAD} = 8 pF, 2.5 V LVDS, R_T = 100 Ω.

AC SPECIFICATIONS¹—ENCODE = 400 MSPS

VA = 3.7 V, VC = 3.3 V, VD = 1.5 V, ENCODE = 400 MSPS, 0°C ≤ T_{CASE} ≤ 60°C, unless otherwise noted.

Table 2.

Parameter	Case Temp	Test Level	AD12401-400KWS			AD12401-400JWS			Unit
			Min	Typ	Max	Min	Typ	Max	
DYNAMIC PERFORMANCE									
SNR									
Analog Input 10 MHz	Full	I	62	64		60	62		dBFS
@ -1.0 dBFS 70 MHz	Full	I	61.5	63.5		59.5	61.5		dBFS
128 MHz	Full	I	60	63		58	61		dBFS
175 MHz	Full	I	60	62.5		57.5	60.5		dBFS
SINAD ²									
Analog Input 10 MHz	Full	I	59	63.5		57	61.5		dBFS
@ -1.0 dBFS 70 MHz	Full	I	58.5	63		56.5	61		dBFS
128 MHz	Full	I	57.5	61.5		55.5	59.5		dBFS
175 MHz	Full	I	55	60		53	58		dBFS
Spurious-Free Dynamic Range ³									
Analog Input 10 MHz	Full	I	69	85		69	85		dBFS
@ -1.0 dBFS 70 MHz	Full	I	69	80		69	80		dBFS
128 MHz	Full	I	66	72		66	72		dBFS
175 MHz	Full	I	62	68		62	68		dBFS
Image Spur ⁴									
Analog Input 10 MHz	Full	I	60	75		60	75		dBFS
@ -1.0 dBFS 70 MHz	Full	I	60	72		60	72		dBFS
128 MHz	Full	I	60	66		60	66		dBFS
175 MHz	Full	I	57	63		57	63		dBFS
Offset Spur ⁴									
Analog Input @ -1.0 dBFS	60°C	V		65			65		dBFS
Two-Tone IMD ⁵									
F1, F2 @ -6 dBFS	60°C	V		-75			-75		dBc
ANALOG INPUT									
Frequency Range	Full	IV	10		175	10		175	MHz
DIGITAL INPUT (DR_EN)									
Minimum Time (Low)	Full	IV	5.0			5.0			ns
SWITCHING SPECIFICATIONS									
Conversion Rate ⁶	Full	IV	396	400	404	396	400	404	MSPS
Encode Pulse Width High (t _{EH}) ¹	60°C	V		1.25			1.25		ns
Encode Pulse Width Low (t _{EL}) ¹	60°C	V		1.25			1.25		ns

Parameter	Case Temp	Test Level	AD12401-400KWS			AD12401-400JWS			Unit
			Min	Typ	Max	Min	Typ	Max	
DIGITAL OUTPUT PARAMETERS									
Valid Time (t_v)	Full	IV		3.9			3.9		ns
Propagation Delay (t_{PD})	60°C	V		8.7			8.7		ns
Rise Time, t_R (20% to 80%)	60°C	V		0.3			0.3		ns
Fall Time, t_F (20% to 80%)	60°C	V		0.3			0.3		ns
DR Propagation Delay (t_{EDR})	60°C	V		11.2			11.2		ns
Data to DR Skew ($t_{EDR} - t_{PD}$)	60°C	V		2.5			2.5		ns
Pipeline Latency ⁷	Full	IV		74			74		Cycles
Start-Up Time	Full	IV	29	44	87	29	44	87	ms
Postprocessing Configuration Time	Full	IV		2.8			2.8		sec
APERTURE DELAY (t_A)	60°C	V		2.3			2.3		ns
APERTURE UNCERTAINTY (Jitter, t_j)	60°C	V		0.4			0.4		ps rms

¹ All ac specifications tested with a single-ended, 2.0 V p-p encode on ENCODE and $\overline{\text{ENCODE}}$ floating.

² The image spur is included in the SINAD measurement.

³ The image spur is not included in the SFDR specification.

⁴ The image spur is at $f_s/2 - A_{IN}$; the offset spur is at $f_s/2$.

⁵ $F_1 = 70$ MHz, $F_2 = 73$ MHz.

⁶ Parts are tested with 400 MSPS encode. Device can be clocked at lower encode rates, but specifications are not guaranteed. Specifications are guaranteed by design for encode 400 MSPS \pm 1%.

⁷ Pipeline latency is exactly 74 cycles with an additional t_{PD} required for data to emerge.

AC SPECIFICATIONS¹—ENCODE = 360 MSPS

$V_A = 3.7$ V, $V_C = 3.3$ V, $V_D = 1.5$ V, encode = 360 MSPS, $0^\circ\text{C} \leq T_{\text{CASE}} \leq 60^\circ\text{C}$, unless otherwise noted.

Table 3.

Parameter	Case Temp	Test Level	AD12401-360KWS			Unit
			Min	Typ	Max	
DYNAMIC PERFORMANCE						
SNR						
Analog Input 10 MHz	Full	I	62	64		dBFS
@ -1.0 dBFS 70 MHz	Full	I	61.5	63.5		dBFS
128 MHz	Full	I	60	63		dBFS
SINAD ²						
Analog Input 10 MHz	Full	I	59	63.5		dBFS
@ -1.0 dBFS 70 MHz	Full	I	58.5	63		dBFS
128 MHz	Full	I	57.5	61.5		dBFS
Spurious-Free Dynamic Range ³						
Analog Input 10 MHz	Full	I	69	85		dBFS
@ -1.0 dBFS 70 MHz	Full	I	69	80		dBFS
128 MHz	Full	I	66	72		dBFS
Image Spur ⁴						
Analog Input 10 MHz	Full	I	60	75		dBFS
@ -1.0 dBFS 70 MHz	Full	I	60	72		dBFS
128 MHz	Full	I	60	66		dBFS
Offset Spur ⁴						
Analog Input @ -1.0 dBFS	60°C	V		65		dBFS
Two-Tone IMD ⁵						
F_1, F_2 @ -6 dBFS	60°C	V		-75		dBc
ANALOG INPUT						
Frequency Range	Full	IV	10		160	MHz
DIGITAL INPUT (DR_EN)						
Minimum Time (Low)	Full	IV	5.6			ns

AD12401

Parameter	Case Temp	Test Level	AD12401-360KWS			Unit
			Min	Typ	Max	
SWITCHING SPECIFICATIONS						
Conversion Rate ⁶	Full	IV	356	360	364	MSPS
Encode Pulse Width High (t_{EH}) ¹	60°C	V		1.38		ns
Encode Pulse Width Low (t_{EL}) ¹	60°C	V		1.38		ns
DIGITAL OUTPUT PARAMETERS						
Valid Time (t_v)	Full	IV		4.5		ns
Propagation Delay (t_{PD})	60°C	V		8.7		ns
Rise Time, t_r (20% to 80%)	60°C	V		0.3		ns
Fall Time, t_f (20% to 80%)	60°C	V		0.3		ns
DR Propagation Delay (t_{EDR})	60°C	V		11.5		ns
Data to DR Skew ($t_{EDR} - t_{PD}$)	60°C	V		2.8		ns
Pipeline Latency ⁷	Full	IV		74		Cycles
Start-Up Time	Full	IV	29	44	87	ms
Postprocessing Configuration Time	Full	IV			3.1	sec
APERTURE DELAY (t_A)	60°C	V		2.3		ns
APERTURE UNCERTAINTY (Jitter, t_j)	60°C	V		0.4		ps rms

¹ All ac specifications tested with a single-ended, 2.0 V p-p encode on ENCODE and $\overline{\text{ENCODE}}$ floating.

² The image spur is included in the SINAD specification.

³ The image spur is not included in the SFDR specification.

⁴ The image spur is at $f_s/2 - A_{IN}$; the offset spur is at $f_s/2$.

⁵ $F1 = 70$ MHz, $F2 = 73$ MHz.

⁶ Parts are tested with 360 MSPS encode. Device can be clocked at lower encode rates, but specifications are not guaranteed. Specifications are guaranteed by design for encode 360 MSPS \pm 1%.

⁷ Pipeline latency is exactly 74 cycles with an additional t_{PD} required for data to emerge.

AC SPECIFICATIONS¹—ENCODE = 326 MSPS

$V_A = 3.7$ V, $V_C = 3.3$ V, $V_D = 1.5$ V, ENCODE = 326 MSPS, $0^\circ\text{C} \leq T_{\text{CASE}} \leq 60^\circ\text{C}$, unless otherwise noted.

Table 4.

Parameter	Case Temp	Test Level	AD12401-326KWS			AD12401-326JWS			Unit
			Min	Typ	Max	Min	Typ	Max	
DYNAMIC PERFORMANCE									
SNR									
Analog Input	10 MHz	Full	I	62	64	60	62		dBFS
@ -1.0 dBFS	70 MHz	Full	I	61.5	63.5	59.5	61.5		dBFS
	128 MHz	Full	I	60	63	58	61		dBFS
SINAD²									
Analog Input	10 MHz	Full	I	59	63.5	57	61.5		dBFS
@ -1.0 dBFS	70 MHz	Full	I	58.5	63	56.5	61		dBFS
	128 MHz	Full	I	57.5	61.5	55.5	59.5		dBFS
Spurious-Free Dynamic Range³									
Analog Input	10 MHz	Full	I	69	85	69	85		dBFS
@ -1.0 dBFS	70 MHz	Full	I	69	80	69	80		dBFS
	128 MHz	Full	I	66	72	66	72		dBFS
Image Spur⁴									
Analog Input	10 MHz	Full	I	60	75	60	75		dBFS
@ -1.0 dBFS	70 MHz	Full	I	60	72	60	72		dBFS
	128 MHz	Full	I	60	66	60	66		dBFS
Offset Spur⁵									
Analog Input @ -1.0 dBFS		60°C	V		65		65		dBFS
Two-Tone IMD⁵									
F1, F2 @ -6 dBFS		60°C	V		-75		-75		dBc

Parameter	Case Temp	Test Level	AD12401-326KWS			AD12401-326JWS			Unit
			Min	Typ	Max	Min	Typ	Max	
ANALOG INPUT									
Frequency Range	Full	IV	10		140	10		140	MHz
DIGITAL INPUT (DR_EN)									
Minimum Time (Low)	Full	IV	6.2			6.2			ns
SWITCHING SPECIFICATIONS									
Conversion Rate ⁶	Full	IV	323	326	329	323	326	329	MSPS
Encode Pulse Width High (t_{EH}) ¹	60°C	V		1.53			1.53		ns
Encode Pulse Width Low (t_{EL}) ¹	60°C	V		1.53			1.53		ns
DIGITAL OUTPUT PARAMETERS									
Valid Time (t_V)	Full	IV		5.0			5.0		ns
Propagation Delay (t_{PD})	60°C	V		8.7			8.7		ns
Rise Time, t_R (20% to 80%)	60°C	V		0.3			0.3		ns
Fall Time, t_F (20% to 80%)	60°C	V		0.3			0.3		ns
DR Propagation Delay (t_{EDR})	60°C	V		11.8			11.8		ns
Data to DR Skew ($t_{EDR} - t_{PD}$)	60°C	V		3.1			3.1		ns
Pipeline Latency ⁷	Full	IV		74			74		Cycles
Start-Up Time	Full	IV	29	44	87	29	44	87	ms
Postprocessing Configuration Time	Full	IV			3.4			3.4	sec
APERTURE DELAY (t_A)	60°C	V		2.3			2.3		ns
APERTURE UNCERTAINTY (Jitter, t_j)	60°C	V		0.4			0.4		ps rms

¹ All ac specifications tested with a single-ended, 2.0 V p-p encode on ENCODE and $\overline{\text{ENCODE}}$ floating.

² The image spur is included in the SINAD measurement.

³ The image spur is not included in the SFDR specification.

⁴ The image spur is at $f_s/2 - A_{IN}$; the offset spur is at $f_s/2$.

⁵ F1 = 70 MHz, F2 = 73 MHz.

⁶ Parts are tested with 326 MSPS encode. Device can be clocked at lower encode rates, but specifications are not guaranteed. Specifications are guaranteed by design for encode 326 MSPS $\pm 1\%$.

⁷ Pipeline latency is exactly 74 cycles with an additional t_{PD} required for data to emerge.

ABSOLUTE MAXIMUM RATINGS

Table 5.

Parameter	Value
VA to AGND	5 V
VC to DGND	4 V
VD to DGND	1.6 V max
Analog Input Voltage	6 V (dc)
Analog Input Power	18 dBm (ac)
ENCODE Input Voltage	6 V (dc)
ENCODE Input Power	12 dBm (ac)
Logic Inputs	-0.3 V to +4 V
Storage Temperature Range, Ambient	-65°C to +150°C
Operating Temperature Range	0°C to 60°C

Stresses above those listed under Absolute Maximum Ratings may cause permanent damage to the device. This is a stress rating only; functional operation of the device at these or any other conditions above those indicated in the operational section of this specification is not implied. Exposure to absolute maximum rating conditions for extended periods may affect device reliability.

EXPLANATION OF TEST LEVELS

Table 6.

Level	Description
I	100% production tested.
II	100% production tested at 25°C and sample tested at specified temperatures.
III	Sample tested only.
IV	Parameter is guaranteed by design and characterization testing.
V	Parameter is a typical value only.
VI	100% production tested at 25°C; guaranteed by design and characterization testing for industrial temperature range; 100% production tested at temperature extremes for military devices.

ESD CAUTION

ESD (electrostatic discharge) sensitive device. Electrostatic charges as high as 4000V readily accumulate on the human body and test equipment and can discharge without detection. Although this product features proprietary ESD protection circuitry, permanent damage may occur on devices subjected to high energy electrostatic discharges. Therefore, proper ESD precautions are recommended to avoid performance degradation or loss of functionality.



Table 7. Output Coding (Twos Complement)

Code	A_{IN} (V)		Digital Output
	KWS	JWS	
4095	+1.6	+0.8	0111 1111 1111
.	.	.	.
.	.	.	.
.	.	.	.
2048	0	0	0000 0000 0000
2047	-0.000781 to	+0.0003905	1111 1111 1111
.	.	.	.
.	.	.	.
0	-1.6 to	+0.8	1000 0000 0000

Table 8. Option Pin List with Necessary Associated Circuitry

Pin Name	Active High	Logic Level Type	Default Level	Associated Circuitry Within Part
RESET	Low	LVTTTL	High	3.74 kΩ Pull-Up
DR_EN	High	LVTTTL	High	Weak Pull-Up (>16 kΩ)

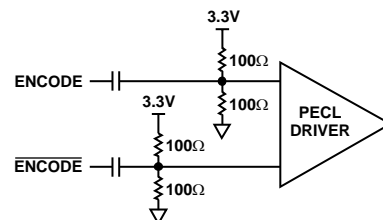
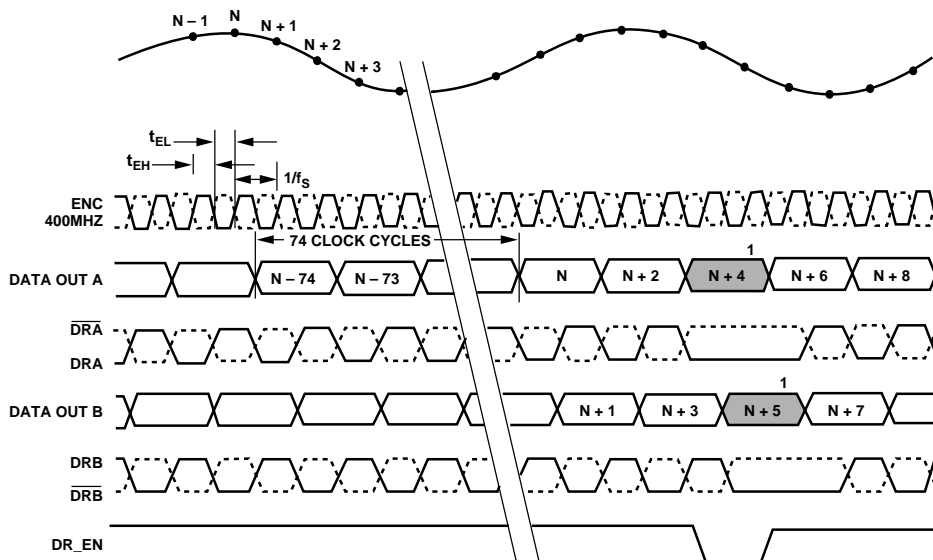

Figure 2. ENCODE Equivalent Circuit



NOTES

1. DATA LOST DUE TO ASSERTION OF DR_EN. LATENCY OF 74 ENCODE CLOCK CYCLES BEFORE DATA VALID.
2. IF A SINGLE-ENDED SINE WAVE IS USED FOR ENCODE, USE THE ZERO CROSSING POINT (AC-COUPLED) AS THE 50% POINT AND APPLY THE SAME TIMING INFORMATION.
3. THE DR_EN PIN IS USED TO SYNCHRONIZE THE COLLECTION OF DATA INTO EXTERNAL BUFFER MEMORIES. THE DR_EN PIN CAN BE APPLIED SYNCHRONOUSLY OR ASYNCHRONOUSLY TO THE AD12401. IF APPLIED ASYNCHRONOUSLY, DR_EN MUST BE HELD LOW FOR A MINIMUM OF 5ns TO ENSURE CORRECT OPERATION. THE FUNCTION SHUTS OFF DRA AND DRB UNTIL THE DR_EN PIN IS SET HIGH AGAIN. DRA AND DRB RESUME ON THE NEXT VALID DRA AFTER DR_EN IS RETURNED HIGH. IF THIS FEATURE IS NOT REQUIRED, TIE THIS PIN TO 3.3V THROUGH A 3.74kΩ RESISTOR OR LEAVE IT FLOATING.

Figure 3. Timing Diagram

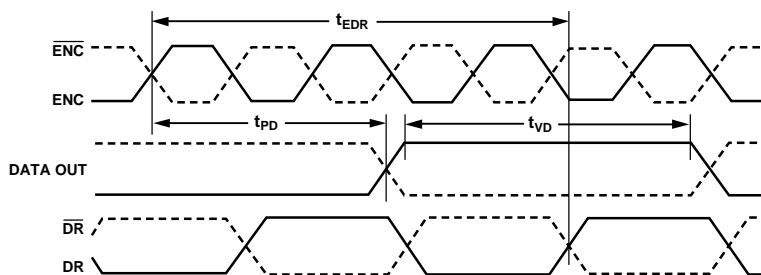

Figure 4. Highlighted Timing Diagram

PIN CONFIGURATION AND FUNCTION DESCRIPTIONS

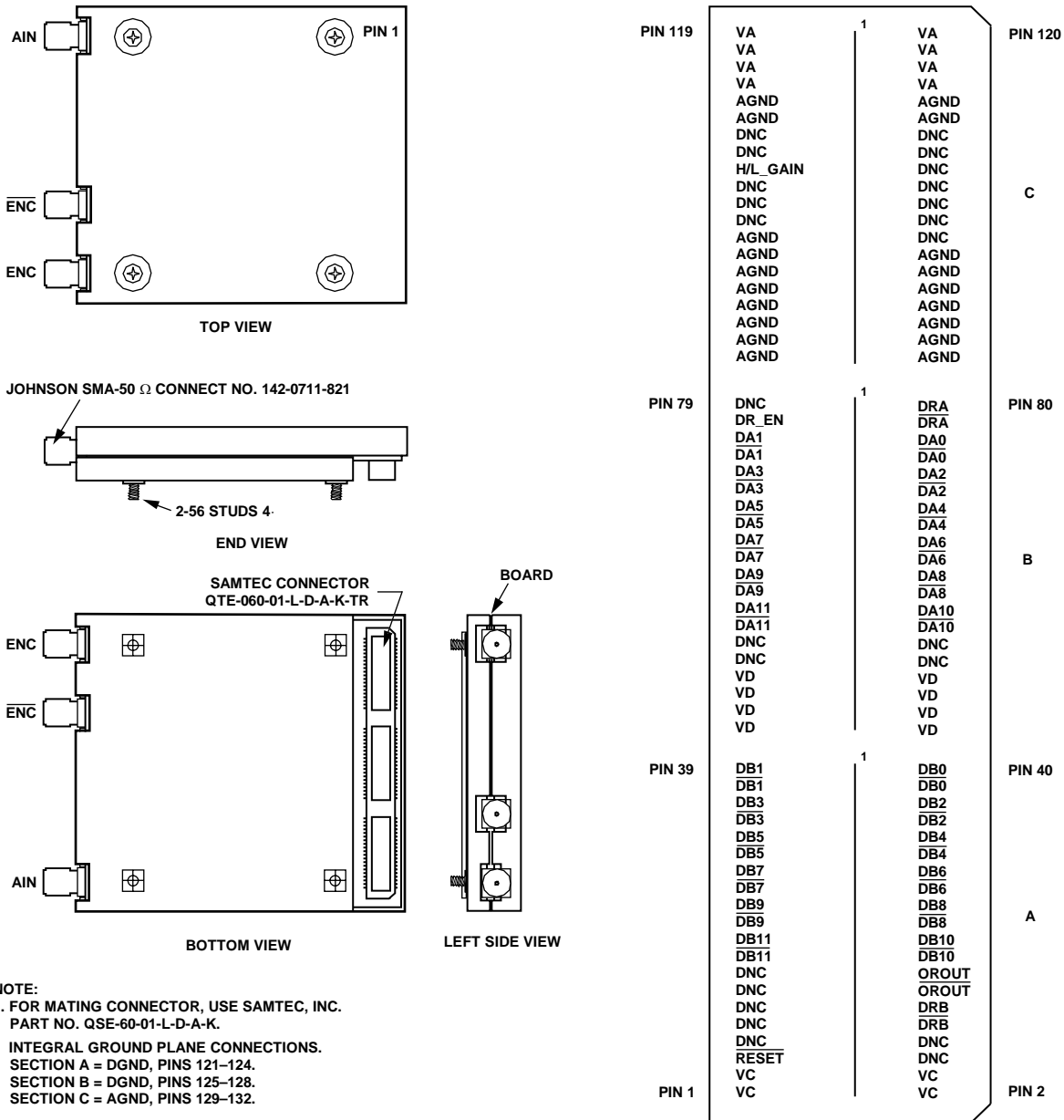

Figure 5. Pin Configuration

Table 9. Pin Function Descriptions

Pin No.	Mnemonic	Description
1 to 4	VC	Digital Supply, 3.3 V.
5	RESET	LVTTL. 0 = device reset. Minimum width = 200 ns. Device resumes operation after 600 ms maximum.
6 to 9, 11, 13, 15, 49 to 52, 79, 96 to 102, 104 to 108	DNC	Do Not Connect.
10	$\overline{\text{DRB}}$	Channel B Data Ready. Complement output.
12	DRB	Channel B Data Ready. True output.
14	$\overline{\text{OROUT}}$	Overrange. Complement output.
16	OROUT	Overrange. True Output 1 = overranged, 0 = normal operation.
17	$\overline{\text{DB11}}$	Channel B Data Bit 11. Complement output bit.
18	$\overline{\text{DB10}}$	Channel B Data Bit 10. Complement output bit.
19	DB11	Channel B Data Bit 11. True output bit.
20	DB10	Channel B Data Bit 10. True output bit.
21	$\overline{\text{DB9}}$	Channel B Data Bit 9. Complement output bit.
22	$\overline{\text{DB8}}$	Channel B Data Bit 8. Complement output bit.
23	DB9	Channel B Data Bit 9. True output bit.
24	DB8	Channel B Data Bit 8. True output bit.
25	$\overline{\text{DB7}}$	Channel B Data Bit 7. Complement output bit.
26	$\overline{\text{DB6}}$	Channel B Data Bit 6. Complement output bit.
27	DB7	Channel B Data Bit 7. True output bit.
28	DB6	Channel B Data Bit 6. True output bit.
29	$\overline{\text{DB5}}$	Channel B Data Bit 5. Complement output bit.
30	$\overline{\text{DB4}}$	Channel B Data Bit 4. Complement output bit.
31	DB5	Channel B Data Bit 5. True output bit.
32	DB4	Channel B Data Bit 4. True output bit.
33	$\overline{\text{DB3}}$	Channel B Data Bit 3. Complement output bit.
34	$\overline{\text{DB2}}$	Channel B Data Bit 2. Complement output bit.
35	DB3	Channel B Data Bit 3. True output bit.
36	DB2	Channel B Data Bit 2. True output bit.
37	$\overline{\text{DB1}}$	Channel B Data Bit 1. Complement output bit.
38	$\overline{\text{DB0}}$	Channel B Data Bit 0. Complement output bit. DB0 is LSB.
39	DB1	Channel B Data Bit 1. True output bit.
40	DB0	Channel B Data Bit 0. True output bit. DB0 is LSB.
41 to 48	VD	Digital Supply, 1.5 V.
53	$\overline{\text{DA11}}$	Channel A Data Bit 11. Complement output bit.
54	$\overline{\text{DA10}}$	Channel A Data Bit 10. Complement output bit.
55	DA11	Channel A Data Bit 11. True output bit.
56	DA10	Channel A Data Bit 10. True output bit.
57	$\overline{\text{DA9}}$	Channel A Data Bit 9. Complement output bit.
58	$\overline{\text{DA8}}$	Channel A Data Bit 8. Complement output bit.
59	DA9	Channel A Data Bit 9. True output bit.
60	DA8	Channel A Data Bit 8. True output bit.
61	$\overline{\text{DA7}}$	Channel A Data Bit 7. Complement output bit.
62	$\overline{\text{DA6}}$	Channel A Data Bit 6. Complement output bit.
63	DA7	Channel A Data Bit 7. True output bit.
64	DA6	Channel A Data Bit 6. True output bit.
65	$\overline{\text{DA5}}$	Channel A Data Bit 5. Complement output bit.
66	$\overline{\text{DA4}}$	Channel A Data Bit 4. Complement output bit.
67	DA5	Channel A Data Bit 5. True output bit.
68	DA4	Channel A Data Bit 4. True output bit.

AD12401

Pin No.	Mnemonic	Description
69	DA3	Channel A Data Bit 3. Complement output bit.
70	DA2	Channel A Data Bit 2. Complement output bit.
71	DA3	Channel A Data Bit 3. True output bit.
72	DA2	Channel A Data Bit 2. True output bit.
73	DA1	Channel A Data Bit 1. Complement output bit.
74	DA0	Channel A Data Bit 0. Complement output bit. DA0 is LSB.
75	DA1	Channel A Data Bit 1. True output bit.
76	DA0	Channel A Data Bit 0. True output bit. DA0 is LSB.
77	DR_EN	Data Ready Enable, Typically DNC. See the DR_EN section.
78	DRA	Channel A Data Ready. Complement output.
80	DRA	Channel A Data Ready. True output.
103	H/L GAIN	Gain Select Pin. Ground for low gain mode (KWS); pull up to 3.3 V for high gain mode (JWS).
81 to 95, 109 to 112, 129 to 132 ¹	AGND	Analog Ground.
113 to 120	VA	Analog Supply, 3.7 V.
121 to 128 ¹	DGND	Digital Ground.

¹ Internal ground plane connections: Section A = DGND, Pin 121 to Pin 124; Section B = DGND, Pin 125 to Pin 128; Section C = AGND, Pin 129 to Pin 132.

TERMINOLOGY

Analog Bandwidth

The analog input frequency at which the spectral power of the fundamental frequency (as determined by the FFT analysis) is reduced by 3 dB.

Aperture Delay

The delay between the 50% point on the rising edge of the ENCODE command and the instant at which the analog input is sampled.

Analog Input VSWR (50 Ω)

VSWR is a ratio of the transmitted and reflected signals. The VSWR can be related to input impedance.

$$\Gamma = (Z_L - Z_S)/(Z_L + Z_S)$$

where:

Z_L = actual load impedance.

Z_S = reference impedance.

$$VSWR = (1 - |\Gamma|)/(1 + |\Gamma|)$$

Aperture Uncertainty (Jitter)

The sample-to-sample variation in aperture delay.

Differential Nonlinearity

The deviation of any code width from an ideal 1 LSB step.

Distortion, Image Spur

The ratio of the rms signal amplitude to the rms signal amplitude of the image spur, reported in dBFS. The image spur, a result of gain and phase errors between two time-interleaved conversion channels, is located at $f_s/2 - f_{AIN}$.

Distortion, Offset Spur

The ratio of the rms signal amplitude to the rms signal amplitude of the offset spur, reported in dBFS. The offset spur, a result of offset errors between two time-interleaved conversion channels, is located at $f_s/2$.

Effective Number of Bits (ENOB)

Calculated from the measured SNR based on the equation

$$ENOB = \frac{SNR_{MEASURED} - 1.76 \text{ dB}}{6.02}$$

ENCODE Pulse Width/Duty Cycle

Pulse width high is the minimum amount of time the ENCODE pulse should be left in Logic 1 state to achieve rated performance; pulse width low is the minimum time the ENCODE pulse should be left in low state.

Full-Scale Input Power

Expressed in dBm. Computed using the equation

$$POWER_{Full-Scale} = 10 \log ((V^2_{Full-Scale}{}^{rms})/(|Z_{INPUT}| \times 0.001))$$

Full-Scale Input Voltage Range

The maximum peak-to-peak input signal magnitude that results in a full-scale response, 0 dBFS on a single-tone input signal case. Any magnitude increase from this value results in an overrange condition.

Gain Error

The difference between the measured and ideal full-scale input voltage range of the ADC.

Harmonic Distortion, Second

The ratio of the rms signal amplitude to the rms value of the second harmonic component, reported in dBFS.

Harmonic Distortion, Third

The ratio of the rms signal amplitude to the rms value of the third harmonic component, reported in dBFS.

Integral Nonlinearity

The deviation of the transfer function from a reference line measured in fractions of 1 LSB using a best straight line determined by a least square curve fit.

Maximum Conversion Rate

The maximum ENCODE rate at which the image spur calibration degrades no more than 1 dB (when the image spur is 70 dB).

Minimum Conversion Rate

The minimum ENCODE rate at which the image spur calibration degrades no more than 1 dB (when the image spur is 70 dB).

Offset Error

The dc offset imposed on the input signal by the ADC, reported in LSB (codes).

Output Propagation Delay

The delay between a differential crossing of ENCODE and ENCODE (or zero crossing of a single-ended ENCODE).

Pipeline Latency

The number of clock cycles the output data lags the corresponding clock cycle.

Power Supply Rejection Ratio (PSRR)

The ratio of power supply voltage change to the resulting ADC output voltage change.

Signal-to-Noise-and-Distortion (SINAD)

The ratio of the rms signal amplitude (set 1 dB below full scale) to the rms value of the sum of all other spectral components, including harmonics, but excluding dc and image spur.

Signal-to-Noise Ratio (SNR)

The ratio of the rms signal amplitude (set at 1 dB below full scale) to the rms value of the sum of all other spectral components, excluding the first five harmonics and dc.

Spurious-Free Dynamic Range (SFDR)

The ratio of the rms signal amplitude to the rms value of the peak spurious spectral component, except the image spur. The peak spurious component may or may not be a harmonic. It can be reported in dBc (that is, degrades as signal level is lowered) or dBFS (always related back to converter full-scale).

Total Noise

Calculated as

$$V_{NOISE} = \sqrt{Z \times 0.001 \times 10^{\left(\frac{FS_{dBm} - SNR_{dBc} - Signal_{dBFS}}{10}\right)}}$$

where:

Z is the input impedance.

FS is the full scale of the device for the frequency in question.

SNR is the value of the particular input level.

$Signal$ is the signal level within the ADC reported in dB below full scale. This value includes both thermal and quantization noise.

Two-Tone Intermodulation Distortion Rejection

The ratio of the rms value of either input tone to the rms value of the worst third-order intermodulation product; reported in dBc.

Two-Tone SFDR

The ratio of the rms value of either input tone to the rms value of the peak spurious component. The peak spurious component may or may not be an IMD product. It can be reported in dBc (that is, degrades as signal level is lowered) or in dBFS (always related back to converter full-scale).

TYPICAL PERFORMANCE CHARACTERISTICS

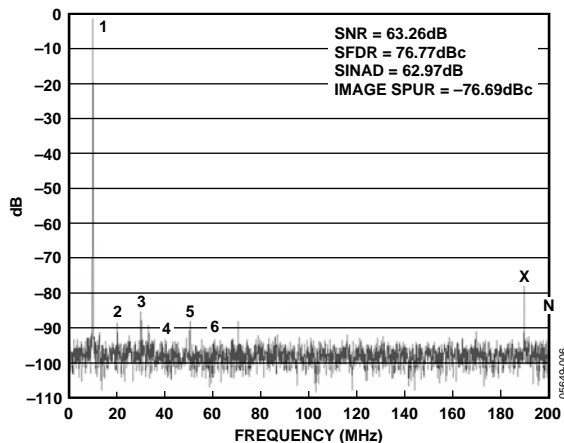

Figure 6. FFT: $f_s = 400$ MSPS, $A_{IN} = 10.123$ MHz @ -1.0 dBFS;
 $X =$ Image Spur, $N =$ Interleaved Offset Spur

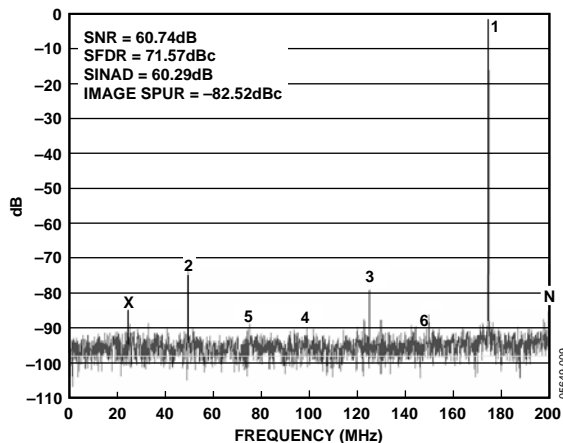

Figure 9. FFT: $f_s = 400$ MSPS, $A_{IN} = 175.123$ MHz @ -1.0 dBFS;
 $X =$ Image Spur, $N =$ Interleaved Offset Spur

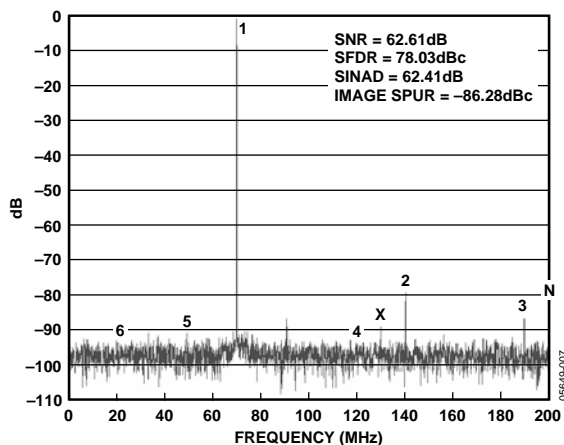

Figure 7. FFT: $f_s = 400$ MSPS, $A_{IN} = 70.123$ MHz @ -1.0 dBFS;
 $X =$ Image Spur, $N =$ Interleaved Offset Spur

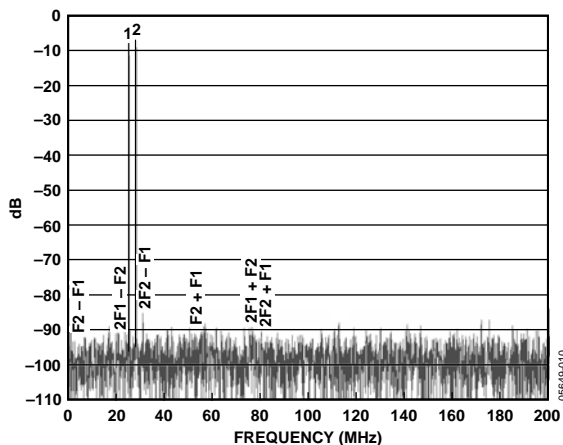

Figure 10. Two-Tone Intermodulation Distortion (25.1 MHz and 28.1 MHz; $f_s = 400$ MSPS);
 $X =$ Image Spur, $N =$ Interleaved Offset Spur

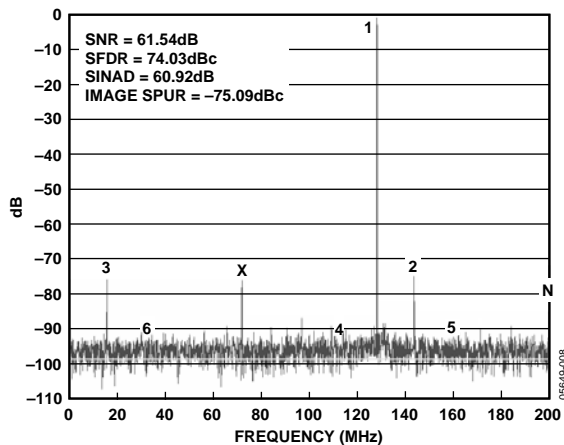

Figure 8. FFT: $f_s = 400$ MSPS, $A_{IN} = 128.123$ MHz @ -1.0 dBFS;
 $X =$ Image Spur, $N =$ Interleaved Offset Spur

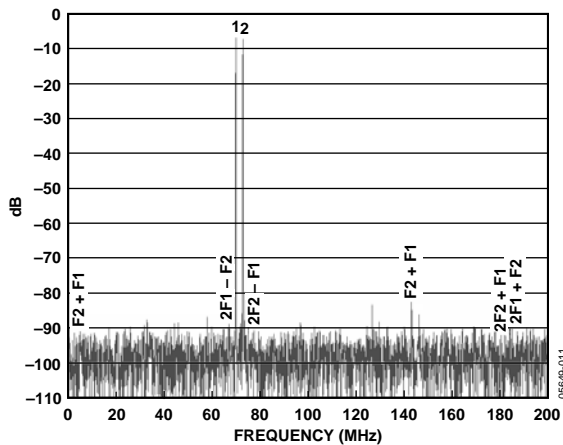

Figure 11. Two-Tone Intermodulation Distortion (70.1 MHz and 73.1 MHz; $f_s = 400$ MSPS);
 $X =$ Image Spur, $N =$ Interleaved Offset Spur

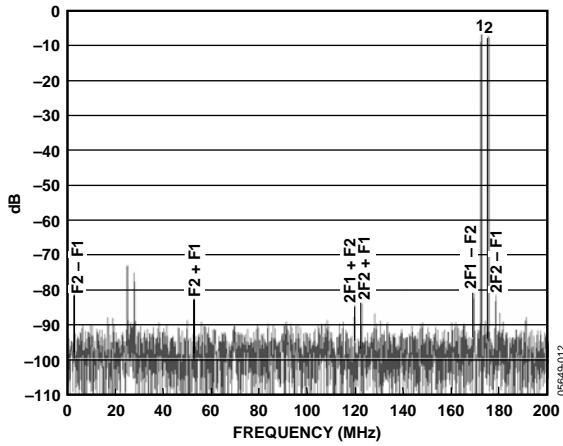

Figure 12. Two-Tone Intermodulation Distortion (172.1 MHz and 175.1 MHz; $f_s = 400$ MSPS), SFDR = 70 dBc; X = Image Spur, N = Interleaved Offset Spur

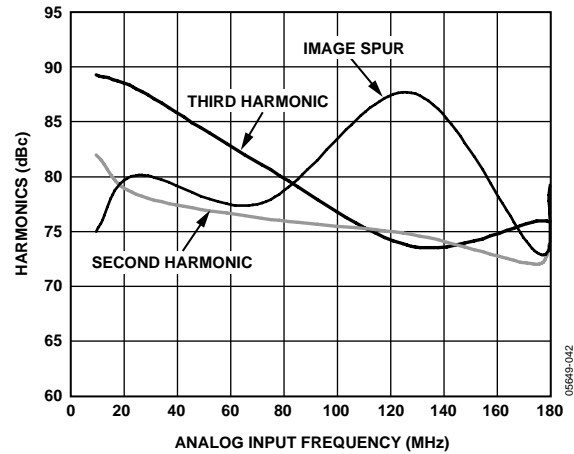

Figure 15. Harmonics vs. Analog Input Frequency

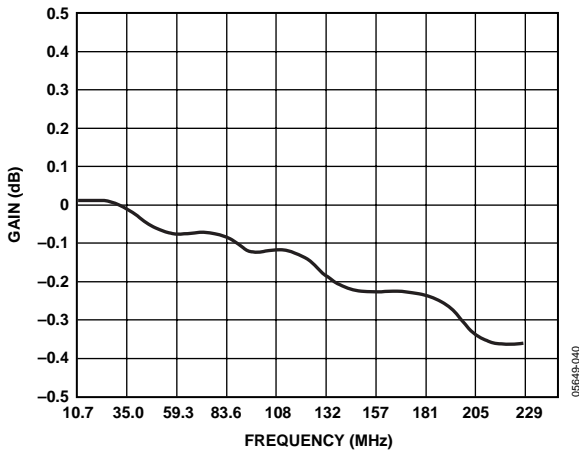

Figure 13. Interleaved Gain Flatness

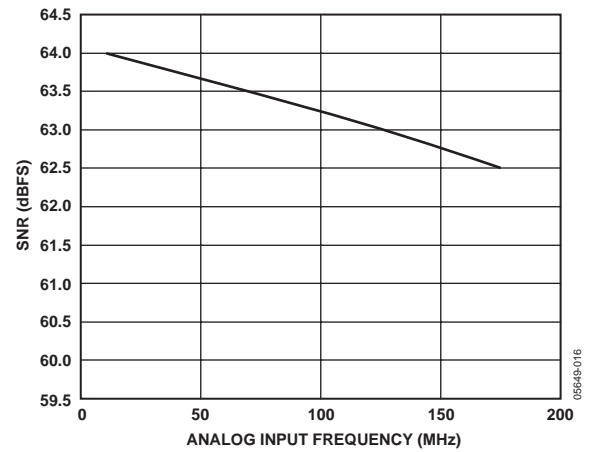

Figure 16. SNR vs. Analog Input Frequency

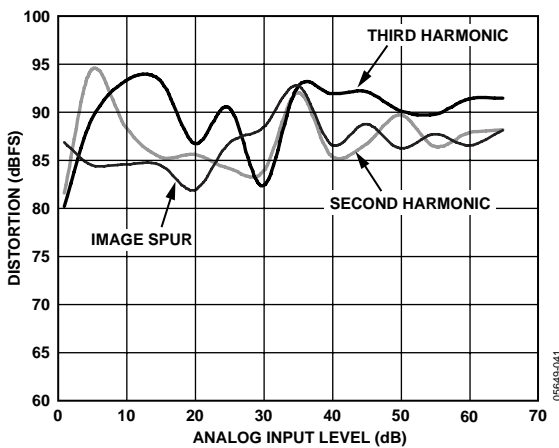

Figure 14. Second/Third Harmonics and Image Spur vs. Analog Input Level; $f_s = 400$ MSPS, $A_{IN} = 70$ MHz

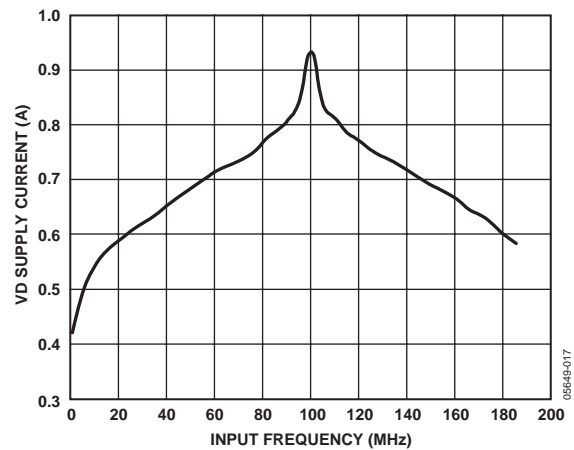

Figure 17. VD Supply Current vs. A_{IN} Frequency

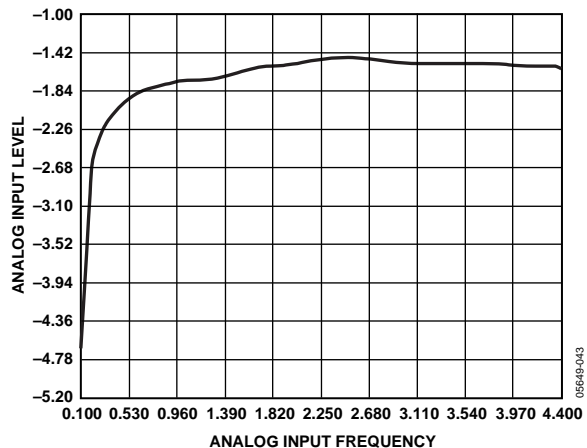

Figure 18. Low Frequency Gain Flatness

THEORY OF OPERATION

The AD12401 uses two high speed, 12-bit ADCs in a time-interleaved configuration to double the sample rate, while maintaining a high level of dynamic range performance. The digital output of each ADC channel is calibrated using a proprietary digital postprocessing technique, Advanced Filter Bank (AFB). AFB is implemented using a state-of-the-art field programmable gate array (FPGA) and provides a wide bandwidth and wide temperature match for any gain, phase, and clock timing errors between each ADC channel.

TIME-INTERLEAVING ADCS

When two ADCs are time-interleaved, gain and/or phase mismatches between each channel produce an image spur at $f_s/2 - f_{AIN}$ and an offset spur, as shown in Figure 19. These mismatches can be the result of any combination of device tolerance, temperature, and frequency deviations.

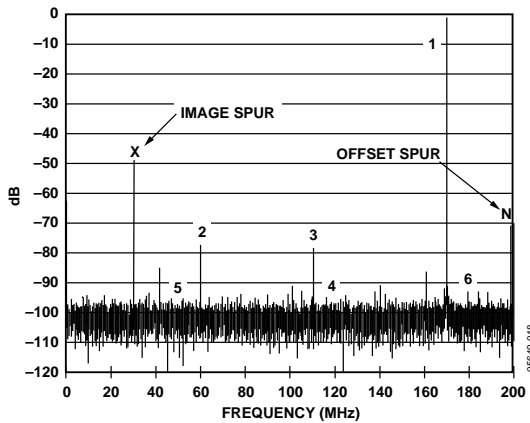

Figure 19. Image Spur due to Mismatches Between Two Interleaved ADCs (No AFB Digital Postprocessing)

Figure 20 shows the performance of a similar converter with on-board AFB postprocessing implemented. The -44 dBFS image spur has been reduced to -77 dBFS and, as a result, the dynamic range of this time-interleaved ADC is no longer limited by the channel matching.

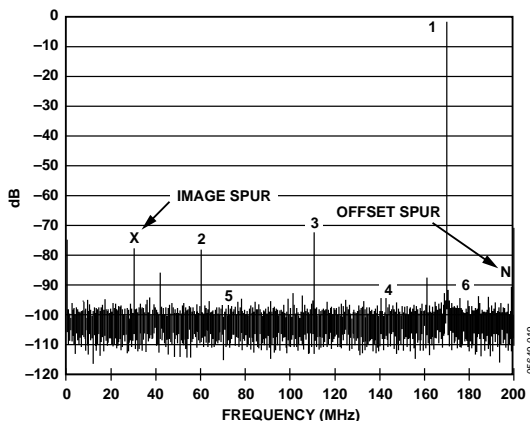

Figure 20. AD12401 with AFB Digital Postprocessing

The relationship between image spur and channel mismatches is captured in Table 10 for specific conditions.

Table 10. Image Spur vs. Channel Mismatch

Gain Error (%)	Aperture Delay Error (ps)	Image Spur (dBc)
1	15	-40
0.25	2.7	-54
0.2	1.1	-62
0.025	0.5	-70

For a more detailed description of time-interleaving in ADCs and a design example using the AD12401, see [Advanced Digital Post-Processing Techniques Enhance Performance in Time-Interleaved ADC Systems](#), which was published in the August, 2003 edition of the Analog Dialogue (www.analog.com/analogDialogue).

ANALOG INPUT

The AD12401 analog input is ac-coupled using a proprietary transformer front-end circuit that provides 1 dB of gain flatness over the first Nyquist zone and a -3 dB bandwidth of 480 MHz. This front-end circuit provides a VSWR of 1.5 (50Ω) over the first Nyquist zone, and the typical full-scale input is 3.2 V p-p. The Mini-Circuits® HELA-10 amplifier module can be used to drive the input at these power levels.

CLOCK INPUT

The AD12401 requires a 400 MSPS ENCODE that is divided by 2 and distributed to each ADC channel, 180° out of phase from each other. Internal ac-coupling and bias networks provide the framework for flexible clock input requirements that include single-ended sine wave, single-ended PECL, and differential PECL. While the AD12401 is tested and calibrated using a single-ended sine wave, properly designed PECL circuits that provide fast slew rates (>1 V/ns) and minimize ringing result in comparable dynamic range performance.

Aperture jitter and harmonic content are two major factors to consider when designing the input clock circuit for the AD12401. The relationship between aperture jitter and SNR can be characterized using the following equation. The equation assumes a full-scale, single-tone input signal.

$$SNR = -20 \log \left[\sqrt{\left(20\pi \times f_A \times 0t_{J_{RMS}}\right)^2 + \frac{1}{1.5} \times \left(\frac{1+\varepsilon}{2^N}\right)^2 + \left(\frac{2\sqrt{2} \times V_{NOISE_{rms}}}{2^N}\right)^2} \right]$$

where:

f_A = input frequency.

$t_{J_{RMS}}$ = aperture jitter.

N = ADC resolution (bits).

ε = ADCDNL (LSB).

$V_{NOISE_{rms}}$ = ADC input noise (LSB rms).

Figure 21 displays the application of this relationship to a full-scale, single-tone input signal on the AD12401, where the DNL was assumed to be 0.4 LSB, and the input noise was assumed to be 0.8 LSB rms. The vertical marker at 0.4 ps displays the SNR at the jitter level present in the AD12401 evaluation system, including the jitter associated with the AD12401 itself.

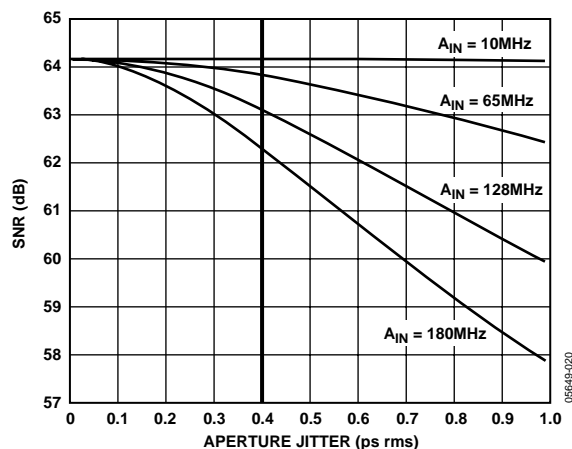

Figure 21. SNR vs. Aperture Jitter

In addition to jitter, the harmonic content of the single-ended sine wave clock sources must be controlled. The clock source used in the test and calibration process has a harmonic performance that is better than 60 dBc. Additionally, when using PECL or other square-wave clock sources, unstable behavior, such as overshoot and ringing, can affect phase matching and degrade the image spur performance.

DIGITAL OUTPUTS

The AD12401's digital postprocessing circuit provides two parallel, 12-bit, 200 MSPS data output buses. By providing two output busses that operate at one half the conversion rate, the AD12401 eliminates the need for large, expensive, high power demultiplexing circuits. The output data format is twos complement, maintaining the standard set by other high speed ADCs, such as the AD9430 and AD6645. Data-ready signals are provided for facilitating proper timing in the data capture circuit.

POWER SUPPLIES

The AD12401 requires three different supply voltages: a 1.5 V supply for the digital postprocessing circuit, a 3.3 V supply to facilitate digital I/O through the system, and a 3.8 V supply for the analog conversion and clock distribution circuits. The AD12401 incorporates two key features that result in solid PSRR performance. First, on-board linear regulators are used to provide an extra level of power supply rejection for the analog circuits. The linear regulator used to supply the ADCs provides an additional 60 dB of rejection at 100 kHz. Second, to address higher frequency noise (where the linear regulators' rejection degrades), the AD12401 incorporates high quality ceramic decoupling capacitors.

While this product was designed to provide good PSRR performance, system designers need to be aware of the risks associated with switching power supplies and consider using linear regulators in their high speed ADC systems. Switching power supplies typically produces both conducted and radiated energy that result in common-/differential-mode EMI currents. Any system that requires 12-bit performance has very little room for errors associated with power supply EMI. For example, a system goal of 74 dB dynamic range performance on the AD12401 requires noise currents that are less than 4.5 μ A and noise voltages of less than 225 μ V in the analog input path.

STARTUP AND RESET

The AD12401's FPGA configuration is stored in the on-board EPROM and loaded into the FPGA when power is applied to the device. The RESET pin (active low) allows the user to reload the FPGA in case of a low digital supply voltage condition or a power supply glitch. Pulling the RESET pin low pulls the data-ready and output bits high until the FPGA is reloaded. The RESET pin should remain low for a minimum of 200 ns. On the rising edge of the reset pulse, the AD12401 starts loading the configuration into the FPGA. The reload process requires a maximum of 87 ms to complete. Valid signals on the data-ready pins indicate the reset process is complete. In addition, system designers must be aware of the thermal conditions of the AD12401 at startup. If large thermal imbalances are present, the AD12401 can require additional time to stabilize before providing specified image spur performance.

DR_EN

The DR_EN pin is used to synchronize the collection of data into external buffer memories. DR_EN must be held low for a minimum amount of time (see Table 2 through Table 4 for each ENCODE rate) to ensure correct operation. The function shuts off DRA and DRB until the DR_EN pin is set high again. DRA and DRB resume on the next valid DRA after DR_EN is released. If this feature is not required, tie this pin to 3.3 V through a 3.74 k Ω .

OVERRANGE

The differential OROUT pins are used to determine if the AD12401 input is overranged. OROUT timing is identical to the Channel B data. If the OROUT pin is high, then the Channel B data coincident with the overrange indication or the Channel A data immediately preceding it resulted from an overrange input. If the OROUT pin is low, the operation is normal.

AD12401

GAIN SELECT

The AD12401 is graded out for the gain mode and should be ordered accordingly: the AD12401-xxxKWS is calibrated in the low gain mode, and the AD12401-xxxJWS is calibrated in the high gain mode. Performance is not guaranteed if either grade is used in the wrong gain mode.

The high gain mode sets the analog input voltage to approximately 1.6 V p-p. The low gain mode sets the analog input voltage to approximately 3.2 V p-p. For high gain mode, the user should pull Pin 103 (H/L_GAIN) up to 3.3 V using a 4.02 k Ω resistor. For low gain mode, the user should ground Pin 103.

THERMAL CONSIDERATIONS

The module is rated to operate over a case temperature of 0°C to 60°C. To maintain the tight channel matching and reliability of the AD12401, care must be taken to ensure that proper thermal and mechanical considerations have been made and addressed to ensure case temperature is kept within this range. Each application requires evaluation of the thermal management as applicable to the system design. This section provides information that should be used in the evaluation of the AD12401's thermal management for each specific use.

In addition to the radiation of heat into its environment, the AD12401 module enables the flow of heat through the mounting studs and standoffs as they contact the motherboard. As described in the Package Integrity/Mounting Guidelines section, the module should be secured to the motherboard using 2-56 nuts (washer use is optional). The torque on the nuts should not exceed 32-inch ounces. Using a thermal grease at the standoffs results in better thermal coupling between the board and module. Depending on the ambient conditions, airflow can be necessary to ensure the components in the module do not exceed their maximum operating temperature. For reliability, the most sensitive component has a maximum junction temperature rating of 125°C.

Figure 22 and Figure 23 provide a basic guideline for two key thermal management decisions: the use of thermal interface material between the module bottom cover/mother board and airflow. Figure 21 characterizes the typical thermal profile of an AD12401 that is not using thermal interface material. Figure 22 provides the same information for a configuration that uses gap-filling thermal interface material. In this case, Thermagon T-flex 600 Series™, 0.040" thickness, was used. These profiles show that the maximum die temperature is reduced by approximately 2°C when thermal interface material is used. Figure 22 and Figure 23 also provide a guideline for determining the airflow requirements for given ambient conditions. For example, a goal of 120°C die temperature in a 40°C ambient environment without the use of thermal interface material requires an airflow of 100 LFM.

From a channel-matching perspective, the most important consideration is external thermal influences. It is possible for thermal imbalances in the end application to adversely affect the dynamic performance. Due to the temperature dependence of the image spur, substantial deviation from the factory calibration conditions can have a detrimental effect. Unbalanced thermal influences can cause gradients across the module, and performance degradation can result. Examples of unbalanced thermal influences can include large heat dissipating elements near one side of the AD12401, or obstructed airflow that does not flow uniformly across the module. The thermal sensitivity of the module can be affected by a change in thermal gradient across the module of 2°C.

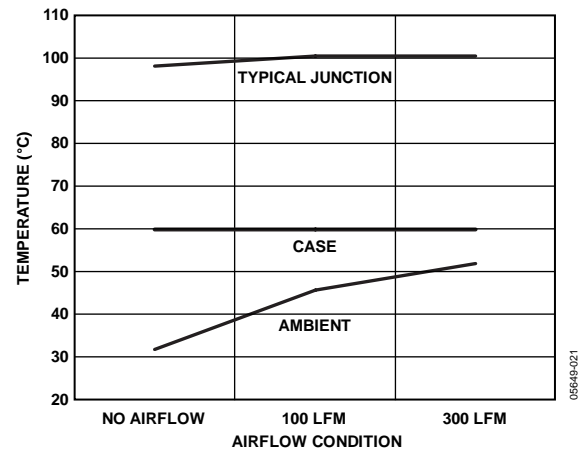

Figure 22. Typical Temperature vs. Airflow with No Module/Board Interface Material (Normalized to 60°C Module Case Temperature)

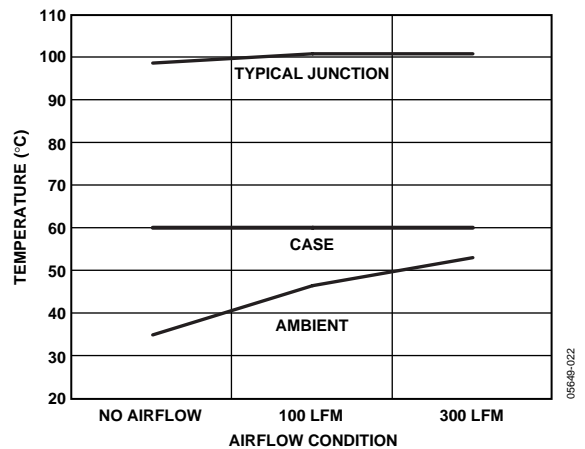

Figure 23. Typical Temperature vs. Airflow with T-flex Module/Board Interface Material (Normalized to 60°C Module Case Temperature Ambient)

PACKAGE INTEGRITY/MOUNTING GUIDELINES

The AD12401 is a printed circuit board (PCB)-based module designed to provide mechanical stability and to support the intricate channel-to-channel matching necessary to achieve high dynamic range performance. The module should be secured to the motherboard using 2-56 nuts (washer use is optional). The torque on the nuts should not exceed 32-inch ounces.

The SMA edge connectors (AIN and ENC/ENC) are surface mounted to the board to achieve minimum height of the module. When attaching and routing the cables, one must ensure they are stress-relieved and do not apply stress to the SMA connector/board. The presence of stress on the cables can degrade electrical performance and mechanical integrity of the module. In addition to the routing precautions, the smallest torque necessary to achieve consistent performance should be used to secure the system cable to the AD12401's SMA connectors. The torque should never exceed 5-inch pounds.

Any disturbances to the AD12401 structure, including removing the covers or mounting screws, invalidates the calibration and results in degraded performance. See the Outline Dimensions section for mounting stud dimensions, see Figure 38 for PCB interface locations. Mounting stud length typically accommodates a PCB thickness of 0.093". Consult sales if board thickness requirements exceed this dimension.

AD12401 EVALUATION KIT

The AD12401/KIT offers an easy way to evaluate the AD12401. The AD12401/KIT includes the AD12401 mounted on an adapter card, the AD12401 evaluation board, the power supply cables, a 225 MHz buffer memory FIFO board, and the Dual Analyzer software. The user must supply a clock source, an analog input source, a 1.5 V power supply, a 3.3 V power supply, a 5 V power supply, and a 3.8 V power supply. The clock source and analog input source connect directly to the AD12401. The power supply cables (included) and a parallel port cable (not included) connect to the evaluation board. The AD12401 works on the same evaluation board as the AD12400 and the AD12500: GS08054.

Power Connector

Power is supplied to the board via a detachable 12-lead power strip (three 4-pin blocks).

Table 11. Power Connector

Supply	Description
VA 3.7 V	Analog supply for the ADC (950 mA typ)
VC 3.3 V	Digital supply for the ADC outputs (400 mA typ)
VD 1.5V ¹	Digital supply for the FPGA (1.25 A max, 0.7 A typ)
VB 5.0 V	Digital supply for the buffer memory board (400 mA typ)

¹ The power supply cable has an approximately 100 mV drop. The VD supply current is dependent on the analog input frequency (see Figure 17).

Analog Input

The analog input source connects directly to an SMA on the AD12401.

H/L_GAIN

The H/L_GAIN select jumper, Pin 103, should be on for low gain mode (AD12401-xxxKWS). The H/L_GAIN select jumper should be removed for high gain mode, AD12401-xxxJWS.

ENCODE

The single-ended or differential ENCODE signal connects directly to SMA connector(s) on the AD12401. A single-ended sine wave at 10 dBm connected to the ENCODE SMA is recommended.

A low jitter clock source (<0.5 ps) is recommended to properly evaluate the AD12401.

DATA OUTPUTS

The AD12401xxxKWS digital outputs are available at the 80-pin connector, P2, on the evaluation board. The AD12401/KIT comes with a buffer memory FIFO board connected to P2, which provides the interface to the parallel port of a PC. The Dual Analyzer software is compatible with Windows® 95, Windows 98, Windows 2000, and Windows NT®.

The buffer memory FIFO board can be removed, and an external logic analyzer or other data acquisition module can be connected to this connector, if required.

Adapter Card

The AD12401 is attached to an adapter card that interfaces to the evaluation board through a 120-pin connector, P1, which is on the top side of the evaluation board.

Digital Postprocessing Control

The evaluation board has a 2-pin jumper, labeled AFB, that allows the user to enable/disable the digital postprocessing. The digital postprocessing is active when the AFB jumper is applied. When the jumper is removed, the FPGA is set to a passthrough mode, which demonstrates to the user the performance of the AD12401 without the digital postprocessing.

RESET

The AD12401's FPGA configuration is stored in an EEPROM and loaded into the FPGA when power is applied to the AD12401. The RESET switch, SW1 (active low), allows the user to reload the FPGA in case of a low voltage condition or a power supply glitch. Depressing the RESET switch pulls the data-ready and output bits high. The RESET switch should remain low for a minimum of 200 ns. On the rising edge of the RESET pulse, the AD12401 starts loading the configuration into the on-module FPGA. The reload process requires a maximum of 600 ms to complete. Valid signals on the data-ready pins indicate the reset process is complete.

The AD12401 is not compatible with the HSC-ADC-EVAL-DC/SC hardware or software.

AD12401

Table 12. Evaluation Board Bill of Materials (BOM)

Item No.	Qty.	Ref-Des	Device	Package	Value, Mfg
1	2	C3, C5	Capacitors	603	0.1 μ F, 25 V
2	2	C4, C6	Capacitors	805	10 μ F, 6.3 V
3	1	R9	Resistor	603	4.02 k Ω , 1%
4	1	AFB	2-Pin Header/Jumper	Pin Strip	Molex/GC/Weldon
5	1	P2	80-Pin Dual Connector Assembly	Surface-Mount	Post Header AMP
6	1	SW1	Switch Push Button SPST	6 MM	Panasonic
7	3	J2, J3, J4	4-Pin Header Power Connectors	Pin Strip	Wieland
8	1	P1	60-Pin Dual-Socket Assembly	Surface-Mount	Samtec
9	1	PCB	AD12401 Interface Board GS08054	PCB	

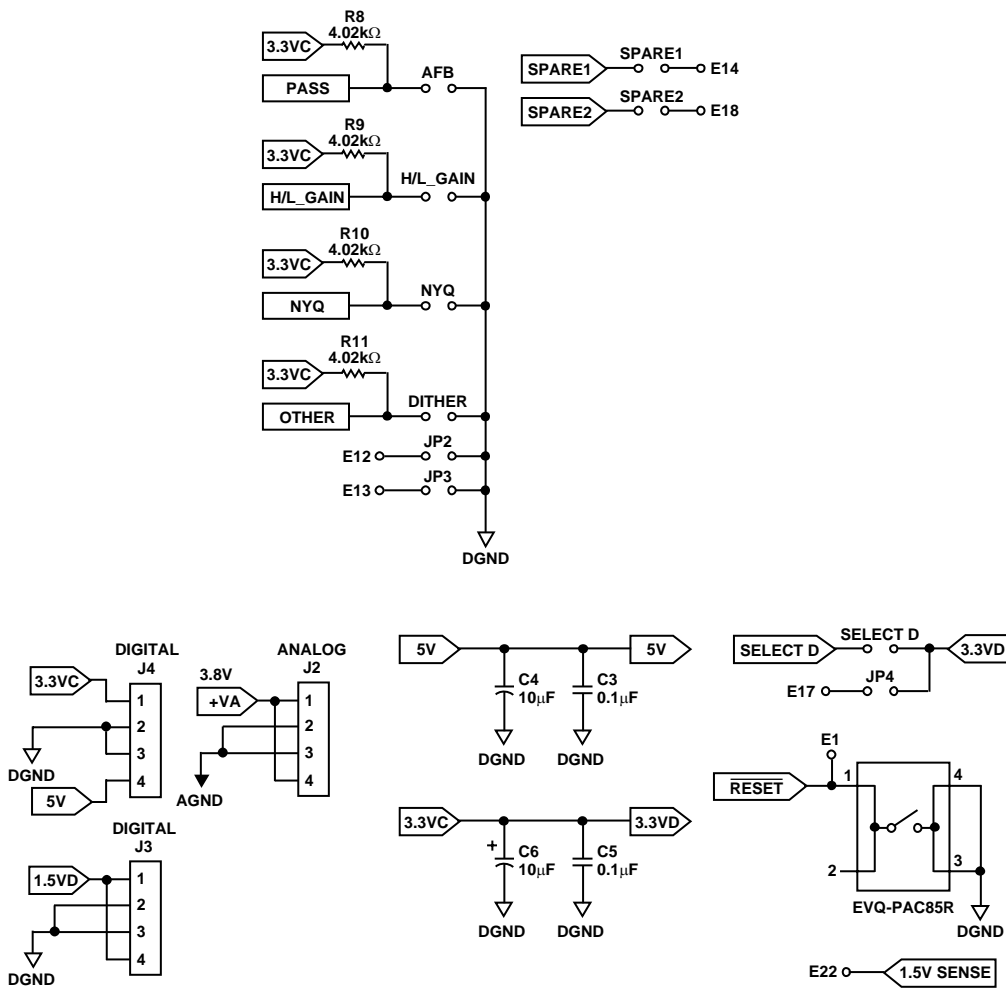

Figure 24. Evaluation Board

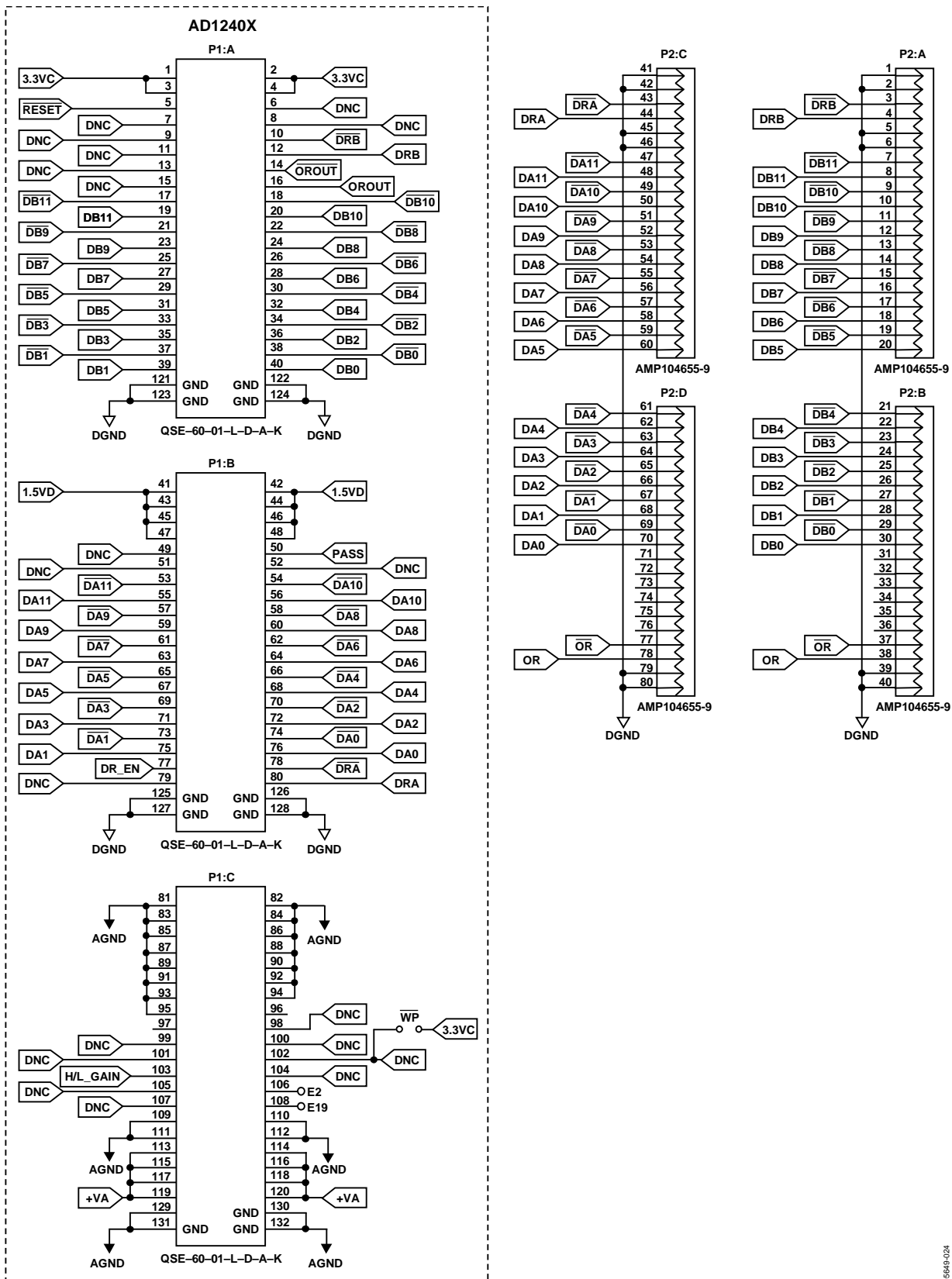
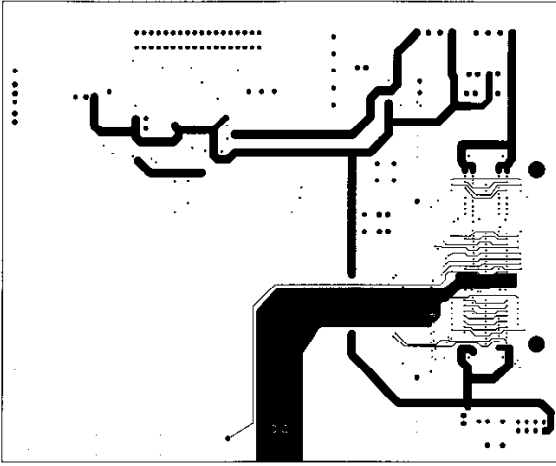
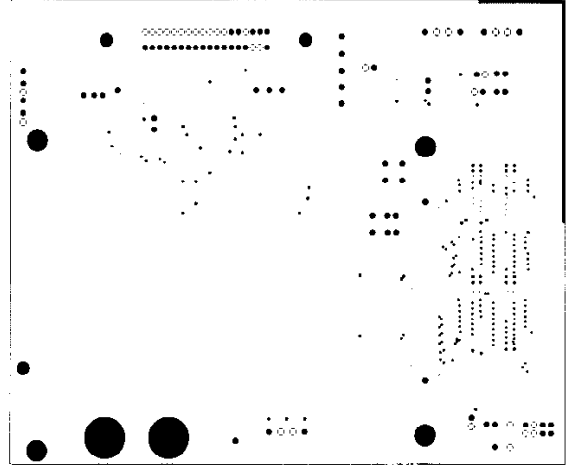

Figure 25. Evaluation Board



05649-025

Figure 26. Power Plane 1



05649-028

Figure 29. Second Ground Plane

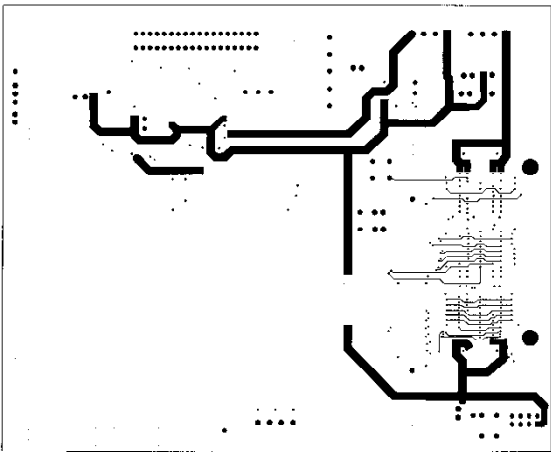

05649-026

Figure 27. Power Plane 2

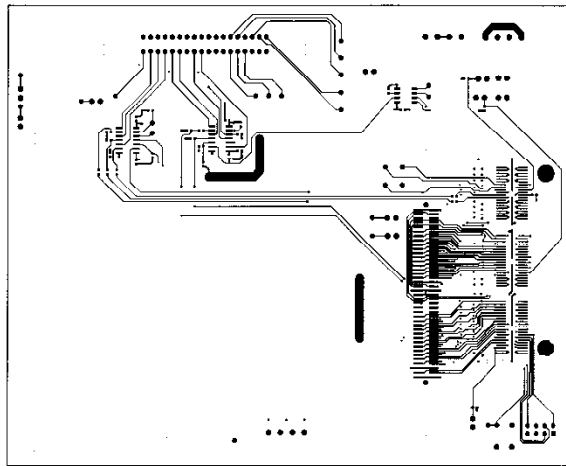

05649-029

Figure 30. Top Side Copper

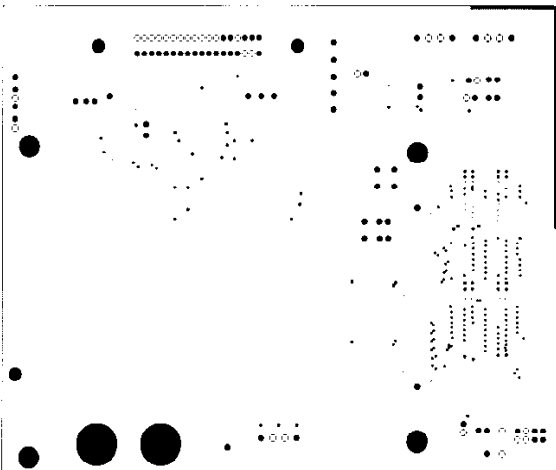

05649-027

Figure 28. First Ground Plane

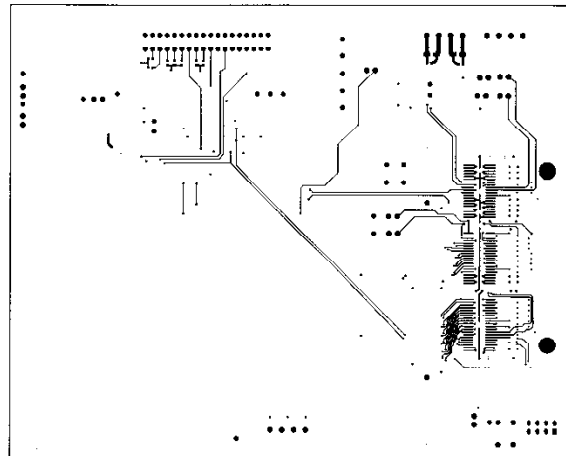

05649-030

Figure 31. Bottom Side Copper

LAYOUT GUIDELINES

The AD12401 requires a different approach from traditional high speed ADC system layouts. While the AD12401's internal PCB isolates digital and analog grounds, these planes are tied together through the product's aluminum case structure. Therefore, the decision to isolate the analog and digital grounds on the system PCB has additional factors to consider.

For example, if the AD12401 is attached with conductive thermal interface material to the system PCB, there is essentially no benefit to keeping the analog and digital ground planes separate. If neither thermal interface material nor nonconductive interface material is used, system architects must consider the ground loop that is created if analog and digital planes are tied together directly under the AD12401. This EMI-based decision must be considered on a case-by-case basis and is largely dependent on the other sources of EMI in the system. One critical consideration is that a 12-bit performance requirement (-74 dBc) requires keeping conducted EMI currents (referenced to the input of the AD12401) below $4.5 \mu\text{A}$. All the characterization and testing of the AD12401 is performed using a system that isolated these ground planes.

If thermal interface material is used in the final system design, the following layout factors need to be considered: open solder mask on the area that contacts the interface material and the thickness of the ground plane. While this should be analyzed in each specific system design, the use of solder mask can negate any advantage achieved by using the thermal interface material, and its use should be carefully considered. The ground plane thickness does not have a major impact on the thermal performance, but if design margin is slight, additional thickness can yield incremental improvements.

PCB INTERFACE

Figure 38 provides the mounting hole footprint for assembling the AD12401 to the second-level assembly. The diagram is referenced to the center of the mating QTE connector. Refer to the QTE/QSE series connector documentation at www.samtec.com for the SMT footprint of the mating connector.

The top view of the second-level assembly footprint provides a diagram of the second-level assembly locating tab locations for mating the Samtec QTE-060-01-L-A-K-TR terminal strip on the AD12401 to a QSE-060-01-L-A-K-TR socket on the second-level assembly. The diagram is referenced to the center of the QTE terminal strip on the AD12401 and the mounting holds for the screws, which holds the AD12401 to the second-level assembly board. The relationship of these locating tabs is based on information provided by Samtec (connector supplier) and should be verified with Samtec by the customer.

Mating and unmating forces—the knifing or peeling action of applying force to one end or one side—must be avoided to prevent damage to the connector and guidepost.

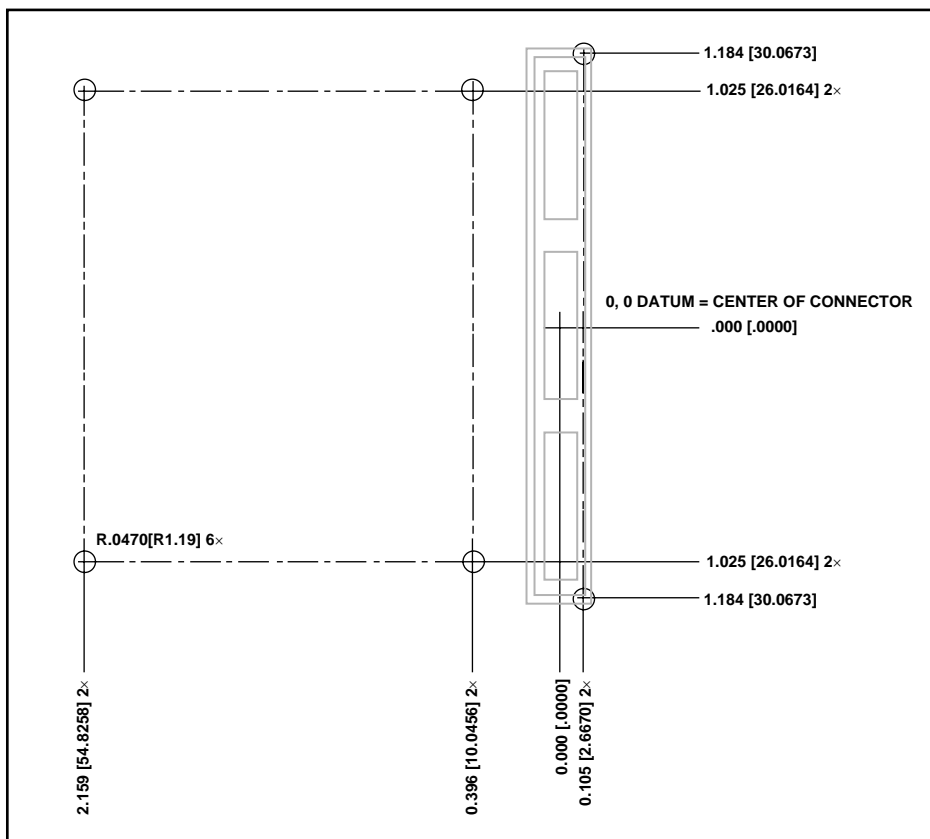

05649-038

Figure 38. Top View of Interface PCB Assembly

AD12401

OUTLINE DIMENSIONS

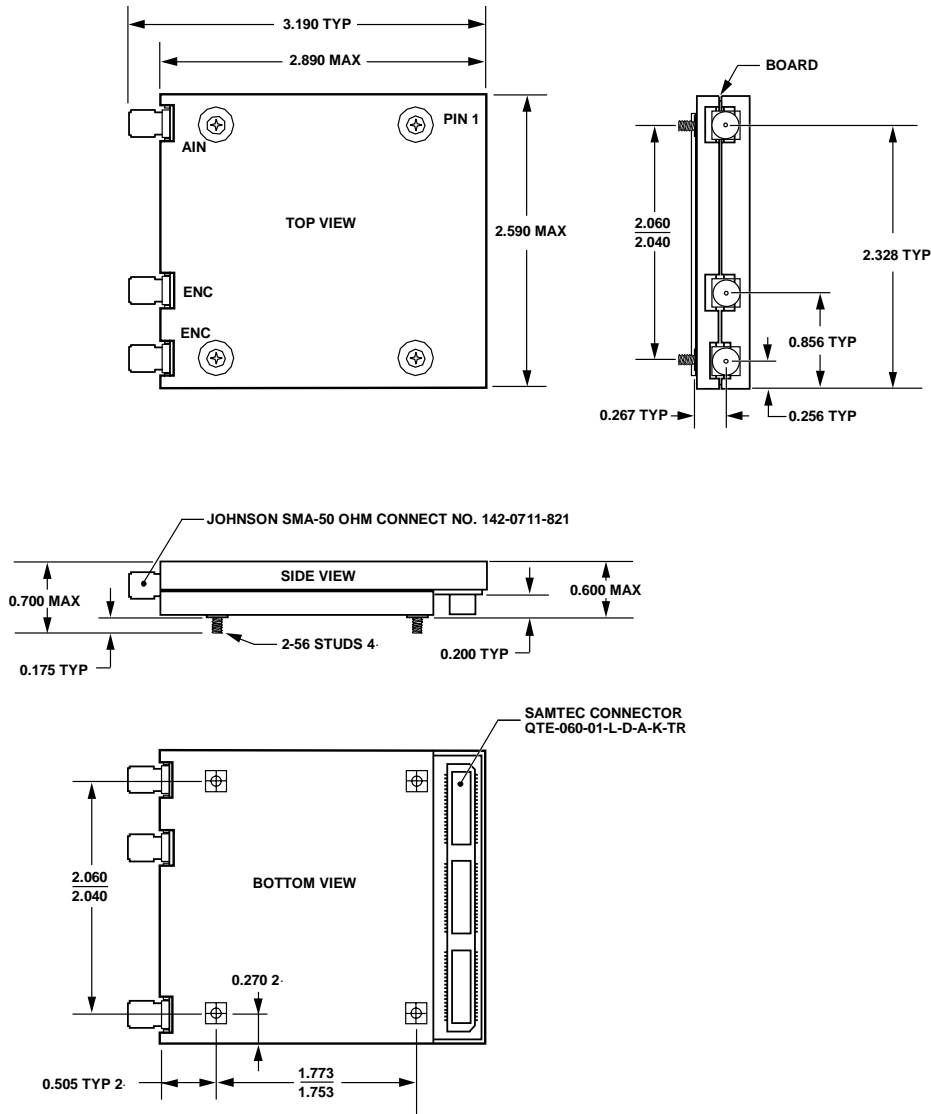

Figure 39. Non-Hermetic Hybrid—Surface-Mounted Parts
(WS-Suffix)

Dimensions shown in inches
Tolerances: 0.xxx = ± 5 mils

ORDERING GUIDE

Model	Temperature Range	Package Description
AD12401-326KWS	0°C to 60°C (Case)	2.9" × 2.6" × 0.6" Module
AD12401-326JWS	0°C to 60°C (Case)	2.9" × 2.6" × 0.6" Module
AD12401-360KWS	0°C to 60°C (Case)	2.9" × 2.6" × 0.6" Module
AD12401-400KWS	0°C to 60°C (Case)	2.9" × 2.6" × 0.6" Module
AD12401-400JWS	0°C to 60°C (Case)	2.9" × 2.6" × 0.6" Module
AD12401/KIT ¹		Evaluation Kit

¹ The encode rate and gain mode must be selected when ordering the AD12401/KIT. The standard AD12401/KIT is configured for low gain mode at 400 MSPS.