

CSTNR7M37GH5L000R0

In Production

Recommended

RoHS

REACH

Appearance & Shape

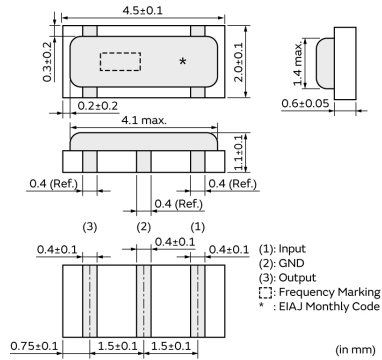
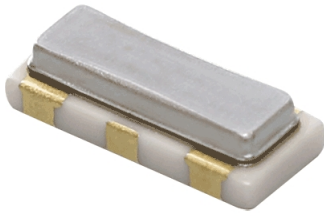

Features

MURATA's frequency adjustment and packaging technology expertise has enabled the development of the chip CERALOCK(R) with built-in load capacitors.

Features

1. Oscillation circuits do not require external load capacitors.
2. Available for a wide frequency range.
3. Extremely small and have a low profile.
4. No adjustment is necessary for oscillation circuits.
5. Stable supply is ensured due to not using precious metal(Palladium).

Applications

Other Usage	Consumer/Industrial
-------------	---------------------

Packaging Information

Packaging	Specifications	Standard Packing Quantity
R0	180mm Embossed Tape	3000

Attention

1. This datasheet is downloaded from the website of Murata Manufacturing Co., Ltd. Therefore, its specifications are subject to change or our products in it may be discontinued without advance notice. Please check with our sales representatives or product engineers before ordering.
2. This datasheet has only typical specifications because there is no space for detailed specifications. Therefore, please review our product specifications or consult the approval sheet for product specifications before ordering.

CSTNR7M37GH5L000R0

Specifications

Product Type	Ceramic Resonator (CERALOCK)
Series	CSTNR_GH5L
Frequency	7.370MHz
Frequency Tolerance	+/-0.07% max.
Operating Temperature Range	-20°C~85°C
Frequency Shift by Temperature	+/-0.11% max.
Frequency Aging	+/-0.07% max.
Resonant Impedance (R1)	50ohm max.
Built-in Load Capacitance (CL1/CL2)	39pF
Shape	SMD
Wash	Not available
L x W (size)	4.5x2.0mm
Mass	26.47mg

Attention

- 1.This datasheet is downloaded from the website of Murata Manufacturing Co., Ltd. Therefore, it's specifications are subject to change or our products in it may be discontinued without advance notice. Please check with our sales representatives or product engineers before ordering.
- 2.This datasheet has only typical specifications because there is no space for detailed specifications. Therefore, please review our product specifications or consult the approval sheet for product specifications before ordering.