

# 600mA Low Noise Multi-LED Camera Light Charge Pumps

## FEATURES

- Charge Pump Provides High Efficiency with Automatic Mode Switching
- Multimode Operation: 1x, 1.5x, 2x
- Four Low Dropout LED Outputs
- Up to 600mA Total Output Current
- Independent Torch and Flash  $I_{SET}$  and Enable Pins
- Low Noise Constant Frequency Operation\*
- PWM Brightness Control via the EN2 Pin
- Low Shutdown Current: 4 $\mu$ A
- Internal Soft-Start Limits Inrush Current During Start-Up and Mode Switching
- Open/Short LED Protection
- No Inductors
- (3mm x 3mm) 16-Lead QFN Plastic Package

## APPLICATIONS

- Multi-LED Camera Light Supply for Cellphones/ DSCs/PDAs

LT, LT, LTC and LTM are registered trademarks of Linear Technology Corporation. All other trademarks are the property of their respective owners. \*Protected by U.S. Patents including 6411531.

## DESCRIPTION

The LTC<sup>®</sup>3217 is a low noise charge pump DC/DC converter designed to power four high current LEDs. The LTC3217 requires only four small ceramic capacitors and two current set resistors to form a complete LED power supply and current controller.

Built-in soft-start circuitry prevents excessive inrush current during start-up and mode changes. High switching frequency enables the use of small external capacitors. Independent high and low current settings are programmed by two external resistors. Shutdown mode and current output levels are selected via two logic inputs.

The current through the LEDs is programmed via  $I_{SET1}$  and  $I_{SET2}$ . In addition, the brightness can be controlled by pulse width modulation of the EN2 pin.

The charge pump optimizes efficiency based on the voltage across the LED current sources. The part powers up in 1x mode and will automatically switch to boost mode whenever any enabled LED current source begins to enter dropout. The first dropout switches the part into 1.5x mode and a subsequent dropout switches the part into 2x mode. The LTC3217 resets to 1x mode whenever the part is shut down.

The LTC3217 is available in a low profile 16-lead (3mm x 3mm x 0.75mm) QFN package.

## TYPICAL APPLICATION

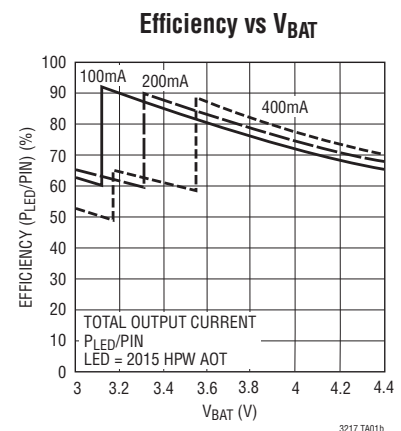
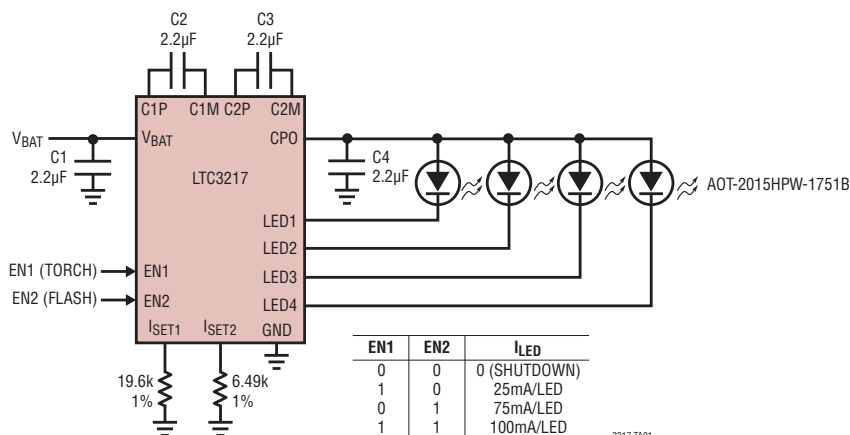

## ABSOLUTE MAXIMUM RATINGS

(Note 1)

$V_{BAT}$ , CPO to GND.....	-0.3V to 6V
EN1, EN2.....	-0.3V to ( $V_{BAT} + 0.3V$ )
$I_{CPO}$ (Note 2).....	600mA
$I_{LED1-4}$ (Note 3).....	150mA
CPO Short-Circuit Duration.....	Indefinite
Operating Temperature Range (Note 4)....	-40°C to 85°C
Storage Temperature Range.....	-65°C to 125°C

## PIN CONFIGURATION

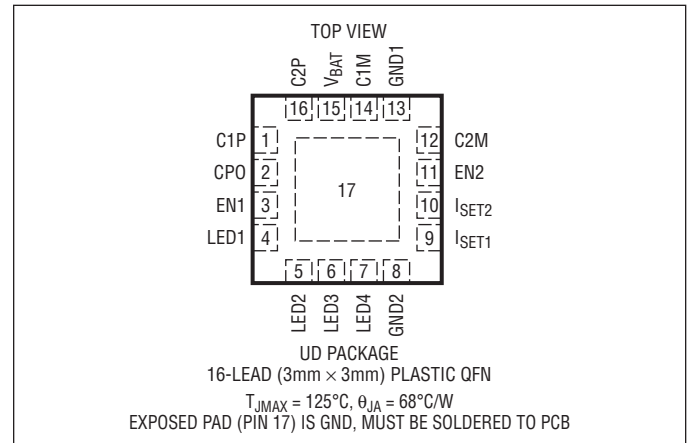

## ORDER INFORMATION

LEAD FREE FINISH	TAPE AND REEL	PART MARKING	PACKAGE DESCRIPTION	TEMPERATURE RANGE
LTC3217EUD#PBF	LTC3217EUD#TRPBF	LBTQ	16-Lead (3mm x 3mm) Plastic QFN	-40°C to 85°C

Consult LTC Marketing for parts specified with wider operating temperature ranges.

Consult LTC Marketing for information on non-standard lead based finish parts.

For more information on lead free part marking, go to: <http://www.linear.com/leadfree/>

For more information on tape and reel specifications, go to: <http://www.linear.com/tapeandreeel/>

## ELECTRICAL CHARACTERISTICS

The ● denotes the specifications which apply over the full operating temperature range, otherwise specifications are at  $T_A = 25^\circ\text{C}$ .  $V_{BAT} = 3.6\text{V}$ ,  $C1 = C2 = C3 = C4 = 2.2\mu\text{F}$ , unless otherwise noted.

PARAMETER	CONDITIONS	MIN	TYP	MAX	UNITS
$V_{BAT}$ Operating Voltage		● 2.9		4.5	V
$I_{VBAT}$ Operating Current	$R_{ISET1} = R_{ISET2} = 20\text{k}$ , EN1 = EN2 = High $I_{CPO} = 0\text{mA}$ , 1x Mode $I_{CPO} = 0\text{mA}$ , 1.5x Mode $I_{CPO} = 0\text{mA}$ , 2x Mode		1 4 6		mA mA mA
$V_{BAT}$ Shutdown Current			4		$\mu\text{A}$
<b>LED 1-4 Current</b>					
LED Current Ratio ( $I_{LED}/I_{SET1/2}$ )	$I_{LED} = 25\text{mA}$ to $100\text{mA}$	● 370	400	430	mA/mA
LED Dropout Voltage	Mode Switch Threshold, $I_{LED} = 100\text{mA}$		330		mV
Mode Switching Delay	EN1 Only		2.5		ms
LED Current Matching	Any Two Outputs, $I_{LED} = 100\text{mA}$		1		%
<b>Charge Pump (CPO)</b>					
1x Mode Output Voltage	$I_{CPO} = 0\text{mA}$		$V_{BAT}$		V
1.5x Mode Output Voltage	$I_{CPO} = 0\text{mA}$		4.5		V
2x Mode Output Voltage	$I_{CPO} = 0\text{mA}$		5.05		V
1x Mode Output Impedance			0.5		$\Omega$
1.5x Mode Output Impedance	$V_{BAT} = 3.4\text{V}$ , $V_{CPO} \leq 4.6\text{V}$ (Note 5)		2.8		$\Omega$
2x Mode Output Impedance	$V_{BAT} = 3.2\text{V}$ , $V_{CPO} \leq 5.1\text{V}$ (Note 5)		3.2		$\Omega$
CLOCK Frequency		● 0.6	0.85	1.15	MHz

3217fa

**ELECTRICAL CHARACTERISTICS** The ● denotes the specifications which apply over the full operating temperature range, otherwise specifications are at  $T_A = 25^\circ\text{C}$ .  $V_{\text{BAT}} = 3.6\text{V}$ ,  $C1 = C2 = C3 = C4 = 2.2\mu\text{F}$ , unless otherwise noted.

**CPO Short Circuit Detection**

Threshold Voltage		●	0.4	1.3	V
Test Current	CPO = 0V, EN1 = EN2 = Low	●	10	30	mA

**Unused LED Detection**

Threshold Voltage	$V_{\text{CPO}} - \text{LED}$	●	0.5	1.5	V
Test Current	LED Tied to CPO	●	4	16	$\mu\text{A}$

**EN1, EN2**

Low Level Input Voltage ( $V_{\text{IL}}$ )		●		0.4	V
High Level Input Voltage ( $V_{\text{IH}}$ )		●	1.4		V
Input Current ( $I_{\text{IH}}$ )		●	7	30	$\mu\text{A}$
Input Current ( $I_{\text{IL}}$ )		●	-1	1	$\mu\text{A}$
Minimum PWM On-Time	EN2 Only	●	50		$\mu\text{s}$
Maximum PWM Off-Time	EN2 to Remain Enabled, EN1 = Low	●		1	ms

**I<sub>SET1</sub>, I<sub>SET2</sub>**

$V_{\text{ISET1}}, \text{ISET2}$	$I_{\text{LED1-4}} = 12.5\text{mA}$	●	1.175	1.215	1.255	V
$I_{\text{ISET1}}, \text{ISET2}$ Current Range		●	31.25		375	$\mu\text{A}$
$I_{\text{ISET1}}, \text{ISET2}$ Short-Circuit Current				800		$\mu\text{A}$

**Note 1:** Stresses beyond those listed under Absolute Maximum Ratings may cause permanent damage to the device. Exposure to any Absolute Maximum Rating condition for extended periods may affect device reliability and lifetime.

**Note 2:** Based on charge pump long-term current density limitations. Assumes an operating duty cycle of  $\leq 10\%$  under absolute maximum conditions for durations less than 10 seconds. Maximum current for continuous operation is 300mA.

**Note 3:** Based on LED current source long-term current density limitations. Assumes an operating duty cycle of  $\leq 10\%$  under absolute

maximum conditions for durations less than 10 seconds. Maximum current for continuous operation is 100mA.

**Note 4:** The LTC3217E is guaranteed to meet performance specifications from  $0^\circ\text{C}$  to  $85^\circ\text{C}$ . Specifications over the  $-40^\circ\text{C}$  to  $85^\circ\text{C}$  ambient operating temperature range are assured by design, characterization and correlation with statistical process controls.

**Note 5:** 1.5x mode output impedance is defined as  $(1.5V_{\text{BAT}} - V_{\text{CPO}})/I_{\text{OUT}}$ . 2x mode output impedance is defined as  $(2V_{\text{BAT}} - V_{\text{CPO}})/I_{\text{OUT}}$ .

**TYPICAL PERFORMANCE CHARACTERISTICS**  $T_A = 25^\circ\text{C}$  unless otherwise noted.

**LED Dropout Voltage vs LED Current**

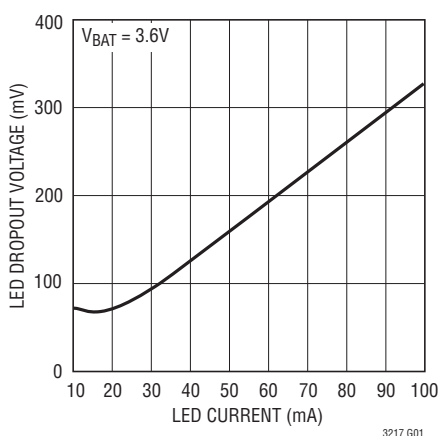

3217 G01

**LED Pin Current vs LED Pin Voltage**

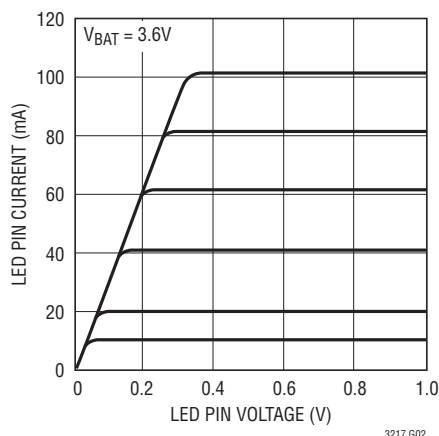

3217 G02

**I<sub>LED</sub> vs R<sub>ISET</sub>**

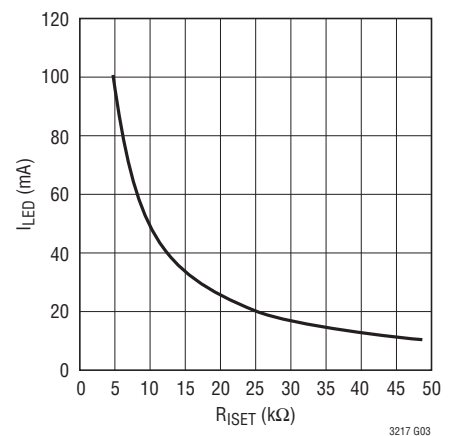

3217 G03

3217fa

## TYPICAL PERFORMANCE CHARACTERISTICS $T_A = 25^\circ\text{C}$ unless otherwise noted.

**1x Mode Switch Resistance vs Temperature**

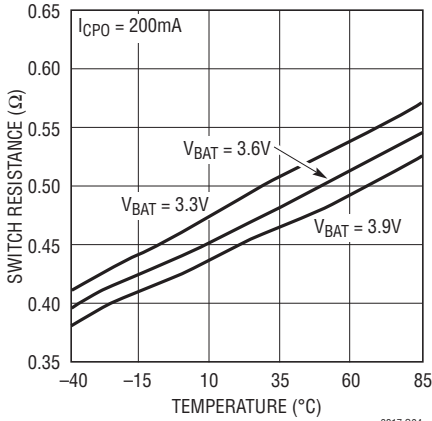

**1.5x Mode Charge Pump Open-Loop Output Resistance vs Temperature  $(1.5V_{BAT} - V_{CPO})/I_{CPO}$**

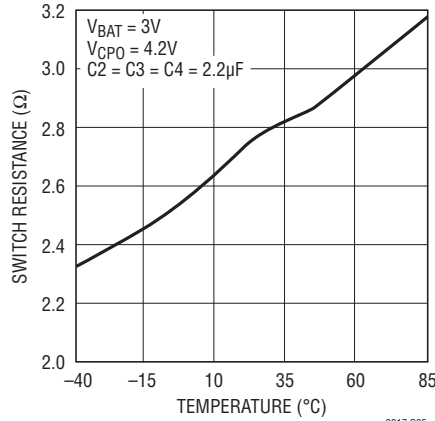

**2x Mode Charge Pump Open-Loop Output Resistance vs Temperature  $(2V_{BAT} - V_{CPO})/I_{CPO}$**

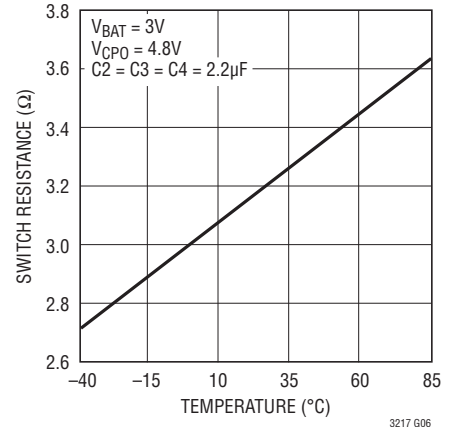

**$V_{BAT}$  Shutdown Current vs  $V_{BAT}$  Voltage**

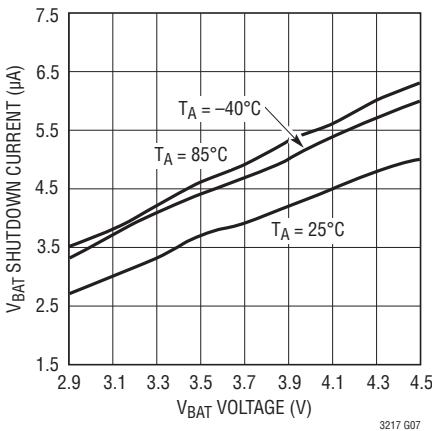

**Oscillator Frequency vs Supply Voltage**

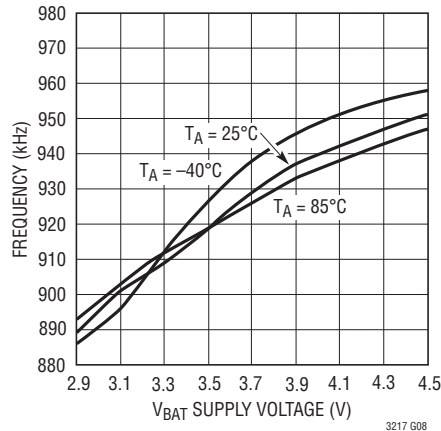

**Efficiency vs  $V_{BAT}$**

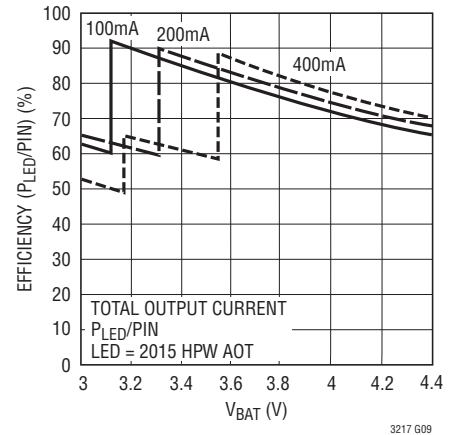

**1.5x Mode CPO Output Ripple**

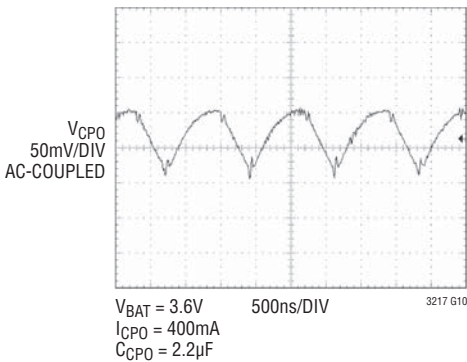

**2x Mode CPO Output Ripple**

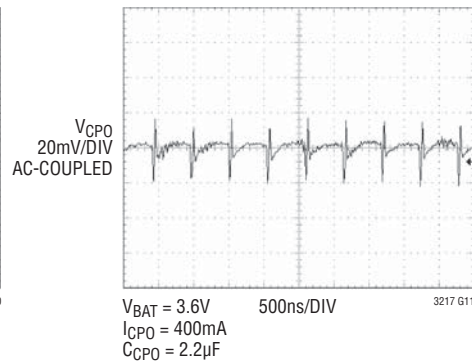

**Charge Pump Mode Switching and Input Current to Ground (400mA Load)**

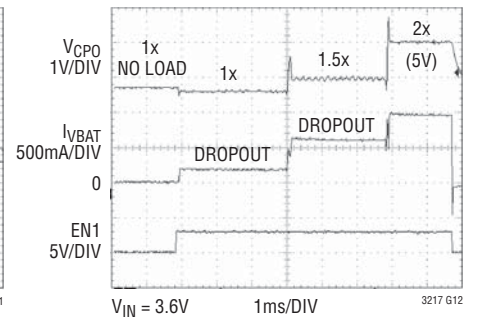

## TYPICAL PERFORMANCE CHARACTERISTICS $T_A = 25^\circ\text{C}$ unless otherwise noted.

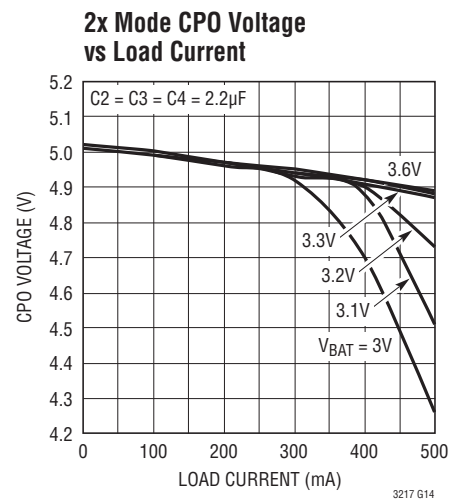
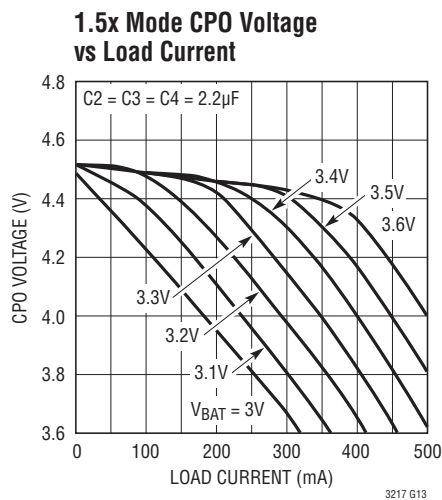

## PIN FUNCTIONS

**C1P, C2P, C1M, C2M (Pins 1, 16, 14, 12):** Charge Pump Flying Capacitor Pins. A  $2.2\mu\text{F}$  X7R or X5R ceramic capacitor should be connected from C1P to C1M and C2P to C2M.

**CPO (Pin 2):** Output of the charge pump used to power all LEDs. This pin is enabled or disabled using the EN1 and EN2 inputs. A  $2.2\mu\text{F}$  X5R or X7R ceramic capacitor should be connected to ground.

**EN1, EN2 (Pins 3, 11):** Inputs. The EN1 and EN2 pins are used to select which current level is being supplied to the LEDs, as well as to put the part into shutdown mode. The truth table for these pins is as follows:

Truth Table

EN1	EN2	MODE
0	0	Shutdown
1	0	Low Current
0	1	High Current
1	1	Low + High Current

EN2 can be used for PWM of the LED currents. For proper operation, the minimum pulse width should be  $50\mu\text{s}$  and the maximum low time should be 1ms if EN1 is low. If EN1 is high then the 1ms low time limitation does not apply.

**LED1, LED2, LED3, LED4 (Pins 4, 5, 6, 7):** LED1 to LED4 are the current source outputs. Each LED is connected

in between CPO (anodes) and LED1 – 4 (cathodes). The current to each LED output is set via the EN1 and EN2 inputs, and the programming resistors connected from  $I_{\text{SET1}}$  and  $I_{\text{SET2}}$  to GND. With the LTC3217, any of the four LED outputs can be disabled by connecting the output directly to CPO.  $10\mu\text{A}$  of current will flow through each directly connected LED output. For single LED applications, all four LED pins may be tied together and will accurately share current.

**GND2 (Pin 8):** Analog Ground. This pin should be connected directly to a low impedance ground plane.

**$I_{\text{SET1}}/I_{\text{SET2}}$  (Pins 9, 10):** LED Current Programming Resistor Pins. The  $I_{\text{SET1}}$  and  $I_{\text{SET2}}$  pins will servo to 1.22V. Resistors connected between each of these pins and GND are used to set the high and low LED current levels. Connecting a resistor 2k or less will cause the LTC3217 to enter overcurrent shutdown.

**GND1 (Pin 13):** Charge Pump Ground. This pin should be connected directly to a low impedance ground plane.

**$V_{\text{BAT}}$  (Pin 15):** Supply Voltage. This pin should be bypassed with a  $2.2\mu\text{F}$ , or greater low ESR ceramic capacitor.

**Exposed Pad (Pin 17):** This pad should be connected directly to a low impedance ground plane for optimal thermal and electrical performance.

## BLOCK DIAGRAM

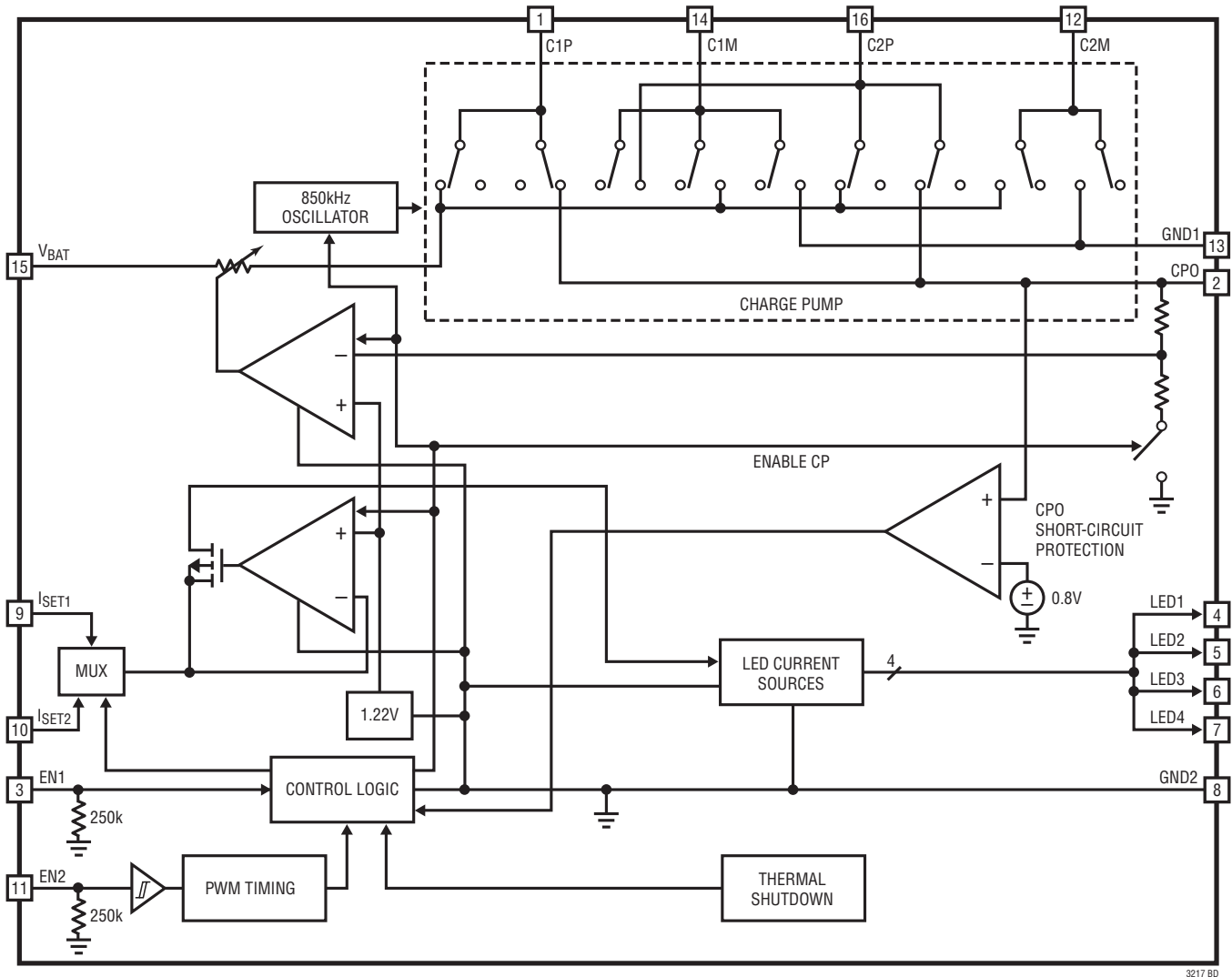

3217 BD

## OPERATION

## Power Management

The LTC3217 uses a switched capacitor charge pump to boost CPO to as much as 2 times the input voltage up to 5.1V. The parts start up in 1x mode. In this mode, V<sub>BAT</sub> is connected directly to CPO. This mode provides maximum efficiency and minimum noise. The LTC3217 will remain in 1x mode until an LED current source drops out. Dropout occurs when a current source voltage becomes too low for the programmed current to be supplied. When dropout is detected, the LTC3217 will switch into 1.5x mode. The CPO voltage will then start to increase and will attempt to reach 1.5x V<sub>BAT</sub> up to 4.5V. Any subsequent dropout will

cause the part to enter the 2x mode. The CPO voltage will attempt to reach 2x V<sub>BAT</sub> up to 5.05V. The LTC3217 will be reset to 1x mode whenever the part is shut down.

A two phase non-overlapping clock activates the charge pump switches. In the 2x mode the flying capacitors are charged on alternate clock phases from V<sub>BAT</sub> to minimize input current ripple and CPO voltage ripple. In 1.5x mode the flying capacitors are charged in series during the first clock phase and stacked in parallel on V<sub>BAT</sub> during the second phase. This sequence of charging and discharging the flying capacitors continues at a constant frequency of 850kHz.

3217fa

## OPERATION

The LED currents are delivered by the four programmable current sources. Three discrete current settings (Low, High, Low + High) are available and may be selected via the EN1 and EN2 pins. The values of these currents may be selected by choosing the appropriate programming resistors. Each resistor is connected between the I<sub>SET1</sub> or I<sub>SET2</sub> pin to ground. The resistor values required to attain the desired current levels can be determined by Equation 1.

$$R_{SET1/2} = \frac{488}{I_{LEDx}} \quad (1)$$

An R<sub>SETx</sub> resistor value of 2k or less (i.e., short-circuit) will cause the LTC3217 to enter overcurrent shutdown mode. This mode prevents damage to the part and external LEDs by shutting down the high power sections of the part.

Each LED output can be disabled by connecting the pin directly to CPO. Do not leave pins open as this will cause dropout and subsequently mode changing.

### Pulse Width Modulation Option

EN2 can be pulse width modulated to control the LED brightness. The minimum allowable pulse width is 50μs and the maximum low time is 1ms. Pulse width modulating the EN2 input can be performed with EN1 high or low. If EN1 is high then there is no limitation on the EN2 low time. When EN1 is low the part would normally go into shutdown whenever EN2 goes low. Prevention of shutdown in this case is achieved by an internal timer which delays shutdown until EN2 has remained low for at least 1ms.

### Soft-Start

Initially, when the part is in shutdown, a weak switch connects V<sub>BAT</sub> to CPO. This allows V<sub>BAT</sub> to slowly charge the CPO output capacitor and prevent large charging currents to occur.

The LTC3217 also employs a soft-start feature on its charge pump to prevent excessive inrush current and supply droop when switching into the step-up modes. The current available to the CPO pin is increased linearly over a typical period of 125μs. Soft-start occurs at the start of both 1.5x and 2x mode changes.

### Charge Pump Strength and Regulation

Regulation is achieved by sensing the voltage at the CPO pin and modulating the charge pump strength based on the error signal. The CPO regulation voltages are set internally, and are dependent on the charge pump modes as shown in Table 1.

When the LTC3217 operates in either 1.5x mode or 2x mode, the charge pump can be modeled as a Thevenin-equivalent circuit to determine the amount of current available from the effective input voltage and effective open-loop output resistance, R<sub>OL</sub> (Figure 1).

**Table 1. Charge Pump Output Regulation Voltages**

CHARGE PUMP MODE	REGULATED V <sub>CPO</sub>
1.5x	4.5V
2x	5.05V

R<sub>OL</sub> is dependent on a number of factors including the switching term, 1/(2f<sub>OSC</sub> • C<sub>FLY</sub>), internal switch resistances and the non-overlap period of the switching circuit. However, for a given R<sub>OL</sub>, the amount of current available will be directly proportional to the advantage voltage of 1.5V<sub>BAT</sub> – V<sub>CPO</sub> for 1.5x mode and 2V<sub>BAT</sub> – V<sub>CPO</sub> for 2x mode. Consider the example of driving white LEDs from a 3.1V supply. If the LED forward voltage is 3.8V and the current sources require 100mV, the advantage voltage for 1.5x mode is 3.1V • 1.5 – 3.8V – 0.1V or 750mV. Notice that if the input voltage is raised to 3.2V, the advantage voltage jumps to 900mV—a 20% improvement in available strength.

From Figure 1, for 1.5x mode the available current is given by:

$$I_{OUT} = \frac{1.5V_{BAT} - V_{CPO}}{R_{OL}} \quad (2)$$

For 2x mode, the available current is given by:

$$I_{OUT} = \frac{2V_{BAT} - V_{CPO}}{R_{OL}} \quad (3)$$

Notice that the advantage voltage in this case is 3.1V • 2 – 3.8V – 0.1V = 2.3V. R<sub>OL</sub> is higher in 2x mode but a significant overall increase in available current is achieved.

## OPERATION

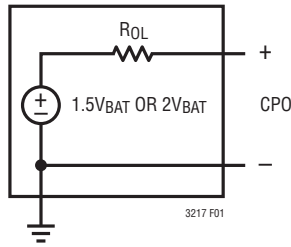

Figure 1. Equivalent Open-Loop Circuit

$V_{CPO}$  in calculating Equations 2 and 3 is the minimum required voltage for the LED and not the regulated voltage.

Typical values of  $R_{OL}$  as a function of temperature are shown in Figures 2 and 3.

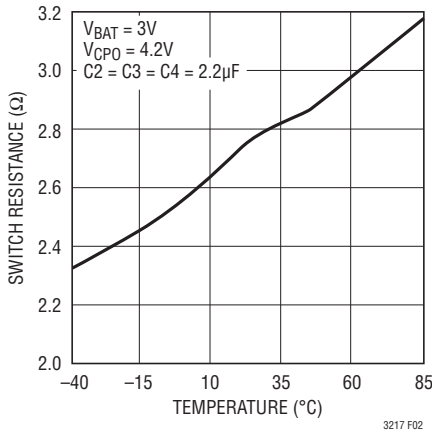

Figure 2. 1.5x Mode Charge Pump Open-Loop Output Resistance vs Temperature  $(1.5V_{BAT} - V_{CPO})/I_{CPO}$

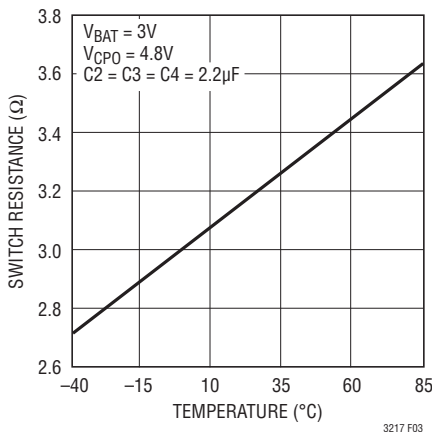

Figure 3. 2x Mode Charge Pump Open-Loop Output Resistance vs Temperature  $(2V_{BAT} - V_{CPO})/I_{CPO}$

### Shutdown Current

In shutdown mode all the circuitry is turned off and the LTC3217 draws a very low current from the  $V_{BAT}$  supply. Furthermore, CPO is weakly connected to  $V_{BAT}$ . The LTC3217 enters shutdown mode when both the EN1 and EN2 pins are brought low. EN1 and EN2 have 250k pull-down resistors to ground.

### Thermal Protection

The LTC3217 has built-in overtemperature protection. At internal die temperatures of around 150°C thermal shutdown will occur. This will disable all of the current sources and charge pump until the die has cooled by about 15°C. This thermal cycling will continue until the fault has been corrected.

### CPO Short-Circuit Protection

The LTC3217 has internal CPO short-circuit protection. An internal comparator senses when CPO is below 0.8V which forces the part into shutdown. A pull-up device ensures start-up.

### Mode Switching

The LTC3217 will automatically switch from 1x mode to 1.5x mode and subsequently to 2x mode whenever a dropout condition is detected at an LED pin. Dropout occurs when a current source voltage becomes too low for the programmed current to be supplied. The time from dropout detection and mode switching is about 2.5ms. This delay allows for the LED to warm up and reduce its forward voltage which may remove the dropout condition.

If PWM is used on the EN2 pin, then the dropout time is dependent on one to two PWM clock pulses.

The part is reset back to 1x mode when the part is shut down (EN1 = EN2 = Low). The part may be set to the desired output current level via EN1 and EN2. An internal comparator will not allow the main switches to connect  $V_{BAT}$  and CPO in 1x mode until the voltage at the CPO pin has decayed to less than or equal to the voltage at the  $V_{BAT}$  pin.



## APPLICATIONS INFORMATION

### $V_{BAT}$ CPO Capacitor Selection

The style and value of the capacitors used with the LTC3217 determine several important parameters such as regulator control loop stability, output ripple, charge pump strength and minimum start-up time.

To reduce noise and ripple, it is recommended that low equivalent series resistance (ESR) ceramic capacitors are used for both  $C_{VBAT}$  and  $C_{CPO}$ . Tantalum and aluminum capacitors are not recommended due to high ESR.

The value of  $C_{CPO}$  directly controls the amount of output ripple for a given load current. Increasing the size of  $C_{CPO}$  will reduce output ripple at the expense of higher start-up current. The peak-to-peak output ripple of the 1.5x mode is approximately given by the expression:

$$I_{RIPPLE-P} = \frac{I_{OUT}}{(3f_{OSC} \cdot C_{CPO})} \quad (4)$$

Where  $f_{OSC}$  is the LTC3217 oscillator frequency or typically 850kHz and  $C_{CPO}$  is the output storage capacitor.

The output ripple in 2x mode is very small due to the fact that load current is supplied on both cycles of the clock.

Both style and value of the output capacitor can significantly affect the stability of the LTC3217. As shown in the Block Diagram, the LTC3217 uses a control loop to adjust the strength of the charge pump to match the required output current. The error signal of the loop is stored directly on the output capacitor. The output capacitor also serves as the dominant pole for the control loop. To prevent ringing or instability, it is important for the output capacitor to maintain at least 1 $\mu$ F of capacitance over all conditions.

In addition, excessive output capacitor ESR will tend to degrade the loop stability. The ESR of the output capacitor should be <100m $\Omega$ . Multilayer ceramic chip capacitors typically have exceptional ESR performance. MLCCs combined with a tight board layout will result in very good stability. As the value of  $C_{CPO}$  controls the amount of output ripple, the value of  $C_{VBAT}$  controls the amount of ripple present at the input pin ( $V_{BAT}$ ). The LTC3217 input

current will be relatively constant while the charge pump is either in the input charging phase or the output charging phase but will drop to zero during the clock non-overlap times. Since the non-overlap time is small (~25ns), these missing “notches” will result in only a small perturbation on the input power supply line. Note that a higher ESR capacitor such as tantalum will have higher input noise due to the higher ESR. Therefore, ceramic capacitors are recommended for low ESR. Input noise can be further reduced by powering the LTC3217 through a very small series inductor as shown in Figure 4. A 10nH inductor will reject the fast current notches, thereby presenting a nearly constant current load to the input power supply. For economy, the 10nH inductor can be fabricated on the PC board with about 1cm (0.4”) of PC board trace.

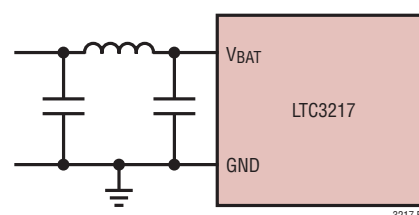

Figure 4. 10nH Inductor Used for Input Noise Reduction (Approximately 1cm of Board Trace)

### Flying Capacitor Selection

**Warning: Polarized capacitors such as tantalum or aluminum should never be used for the flying capacitors since their voltage can reverse upon start-up of the LTC3217. Ceramic capacitors should always be used for the flying capacitors.**

The flying capacitors control the strength of the charge pump. In order to achieve the rated output current it is necessary to have at least 1.6 $\mu$ F of capacitance for each of the flying capacitors. Capacitors of different materials lose their capacitance with higher temperature and voltage at different rates. For example, a ceramic capacitor made of X7R material will retain most of its capacitance from -40°C to 85°C whereas a Z5U or Y5V style capacitor will lose considerable capacitance over that range. Z5U

## APPLICATIONS INFORMATION

and Y5V capacitors may also have a very poor voltage coefficient causing them to lose 60% or more of their capacitance when the rated voltage is applied. Therefore, when comparing different capacitors, it is often more appropriate to compare the amount of achievable capacitance for a given case size rather than comparing the specified capacitance value. For example, over rated voltage and temperature conditions, a 1 $\mu$ F, 10V, Y5V ceramic capacitor in a 0603 case may not provide any more capacitance than a 0.22 $\mu$ F, 10V, X7R available in the same case. The capacitor manufacturer's data sheet should be consulted to determine what value of capacitor is needed to ensure minimum capacitances at all temperatures and voltages.

Table 2 shows a list of ceramic capacitor manufacturers and how to contact them:

**Table 2. Recommended Capacitor Vendors**

AVX	www.avxcorp.com
Kemet	www.kemet.com
Murata	www.murata.com
Taiyo Yuden	www.t-yuden.com
Vishay	www.vishay.com

### Layout Considerations and Noise

Due to its high switching frequency and the transient currents produced by the LTC3217, careful board layout is necessary. A true ground plane and short connections to all capacitors will improve performance and ensure proper regulation under all conditions.

The flying capacitor pins C1P, C2P, C1M and C2M will have very high edge rate waveforms. The large dv/dt on these pins can couple energy capacitively to adjacent PCB runs. Magnetic fields can also be generated if the flying capacitors are not close to the LTC3217 (i.e., the loop area is large). To decouple capacitive energy transfer, a Faraday shield may be used. This is a grounded PCB trace between the sensitive node and the LTC3217 pins. For a high quality AC ground, it should be returned to a solid ground plane that extends all the way to the LTC3217.

The following guidelines should be followed when designing a PCB layout for the LTC3217:

1. The Exposed Pad should be soldered to a large copper plane that is connected to a solid, low impedance ground plane using plated through-hole vias for proper heat sinking and noise protection.
2. Input and output capacitors must be placed close to the part.
3. The flying capacitors must be placed close to the part. The traces from the pins to the capacitor pad should be as wide as possible.
4.  $V_{BAT}$ , CPO traces must be wide to minimize inductance and handle high currents.
5. LED pads must be large and connected to other layers of metal to ensure proper LED heat sinking.

### Power Efficiency

To calculate the power efficiency ( $\eta$ ) of a white LED driver chip, the LED power should be compared to the input power. The difference between these two numbers represents lost power whether it is in the charge pump or the current sources. Stated mathematically, the power efficiency is given by:

$$\eta = \frac{P_{LED}}{P_{IN}} \quad (5)$$

The efficiency of the LTC3217 depends upon the mode in which it is operating. Recall that the LTC3217 operates as a pass switch, connecting  $V_{BAT}$  to CPO, until dropout is detected at the LED pin. This feature provides the optimum efficiency available for a given input voltage and LED forward voltage. When it is operating as a switch, the efficiency is approximated by:

$$\eta = \frac{P_{LED}}{P_{IN}} = \frac{(V_{LED} \cdot I_{LED})}{(V_{BAT} \cdot I_{BAT})} = \frac{V_{LED}}{V_{BAT}} \quad (6)$$

since the input current will be very close to the sum of the LED currents.

## PACKAGE DESCRIPTION

At moderate to high output power, the quiescent current of the LTC3217 is negligible and the expression shown in Equation 6 is valid.

Once dropout is detected at the LED pin, the LTC3217 enables the charge pump in 1.5x mode.

In 1.5x boost mode, the efficiency is similar to that of a linear regulator with an effective input voltage of 1.5 times the actual input voltage. This is because the input current for a 1.5x charge pump is approximately 1.5 times the load current. In an ideal 1.5x charge pump, the power efficiency would be given by:

$$\eta_{IDEAL} = \frac{P_{LED}}{P_{IN}} = \frac{(V_{LED} \cdot I_{LED})}{(V_{BAT} \cdot (1.5) \cdot I_{LED})} = \frac{V_{LED}}{(1.5 \cdot V_{BAT})} \quad (7)$$

Similarly, in 2x boost mode, the efficiency is similar to that of a linear regulator with an effective input voltage

of 2 times the actual input voltage. In an ideal 2x charge pump, the power efficiency would be given by:

$$\eta_{IDEAL} = \frac{P_{LED}}{P_{IN}} = \frac{(V_{LED} \cdot I_{LED})}{(V_{BAT} \cdot (2) \cdot I_{LED})} = \frac{V_{LED}}{(2 \cdot V_{BAT})} \quad (8)$$

## Thermal Management

For higher input voltages and maximum output current, there can be substantial power dissipation in the LTC3217. If the junction temperature increases above approximately 150°C the thermal shutdown circuitry will automatically deactivate the output current sources and charge pump. To reduce maximum junction temperature, a good thermal connection to the PC board is recommended. Connecting the Exposed Pad to a ground plane and maintaining a solid ground plane under the device will reduce the thermal resistance of the package and PC board considerably.

## PACKAGE DESCRIPTION

**UD Package**  
**16-Lead Plastic QFN (3mm × 3mm)**  
 (Reference LTC DWG # 05-08-1691)

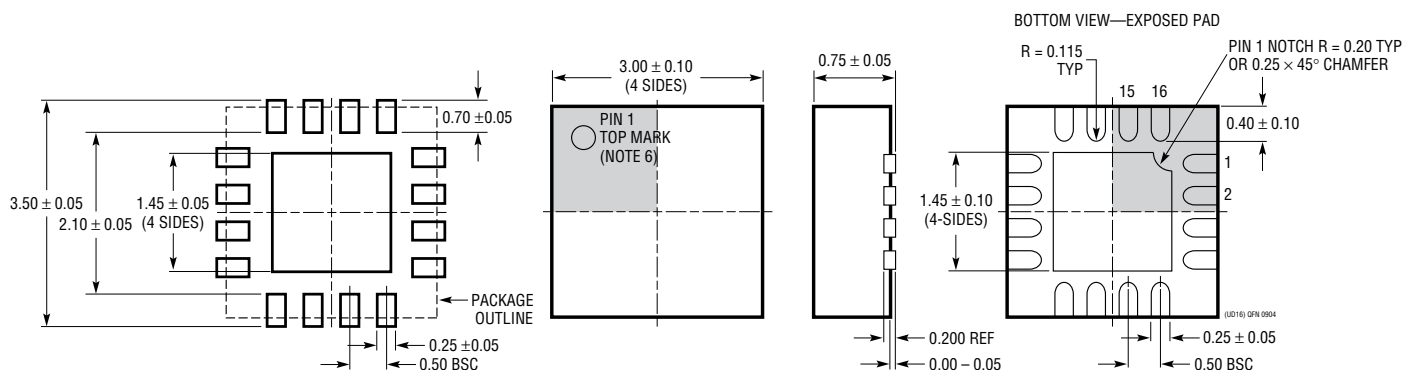

RECOMMENDED SOLDER PAD PITCH AND DIMENSIONS

- NOTE:
1. DRAWING CONFORMS TO JEDEC PACKAGE OUTLINE MO-220 VARIATION (WEED-2)
  2. DRAWING NOT TO SCALE
  3. ALL DIMENSIONS ARE IN MILLIMETERS
  4. DIMENSIONS OF EXPOSED PAD ON BOTTOM OF PACKAGE DO NOT INCLUDE MOLD FLASH. MOLD FLASH, IF PRESENT, SHALL NOT EXCEED 0.15mm ON ANY SIDE

5. EXPOSED PAD SHALL BE SOLDER PLATED
6. SHADED AREA IS ONLY A REFERENCE FOR PIN 1 LOCATION ON THE TOP AND BOTTOM OF PACKAGE

## TYPICAL APPLICATION

### 500mA Camera Flash with PWM Brightness Control

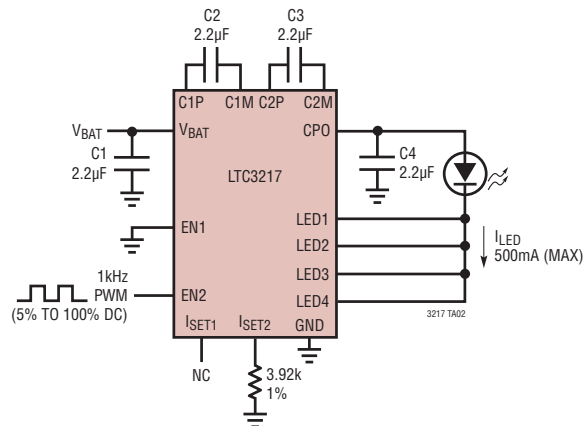

## RELATED PARTS

PART NUMBER	DESCRIPTION	COMMENTS
LT®1618	Constant Current, Constant Voltage, 1.4MHz High Efficiency Boost Regulator	Up to 16 White LEDs, $V_{IN}$ : 1.6V to 18V, $V_{OUT(MAX)}$ = 34V, $I_Q$ = 1.8mA, $I_{SD} \leq 1\mu A$ , 10-Lead MS Package
LTC1911-1.5	250mA ( $I_{OUT}$ ), 1.5MHz High Efficiency Step-Down Charge Pump	75% Efficiency, $V_{IN}$ : 2.7V to 5.5V, $V_{OUT(MAX)}$ = 1.5V/1.8V, $I_Q$ = 180µA, $I_{SD} \leq 10\mu A$ , MS8 Package
LT1932	Constant Current, 1.2MHz High Efficiency White LED Boost Regulator	Up to 8 White LEDs, $V_{IN}$ : 1V to 10V, $V_{OUT(MAX)}$ = 34V, $I_Q$ = 1.2mA, $I_{SD} \leq 1\mu A$ , ThinSOT™ Package
LT1937	Constant Current, 1.2MHz High Efficiency White LED Boost Regulator	Up to 4 White LEDs, $V_{IN}$ : 2.5V to 10V, $V_{OUT(MAX)}$ = 34V, $I_Q$ = 1.9mA, $I_{SD} \leq 1\mu A$ , ThinSOT, SC70 Packages
LTC3200-5	Low Noise, 2MHz Regulated Charge Pump White LED Driver	Up to 6 White LEDs, $V_{IN}$ : 2.7V to 4.5V, $V_{OUT(MAX)}$ = 5V, $I_Q$ = 8mA, $I_{SD} \leq 1\mu A$ , ThinSOT Package
LTC3201	Low Noise, 1.7MHz Regulated Charge Pump White LED Driver	Up to 6 White LEDs, $V_{IN}$ : 2.7V to 4.5V, $V_{OUT(MAX)}$ = 5V, $I_Q$ = 6.5mA, $I_{SD} \leq 1\mu A$ , 10-Lead MS Package
LTC3202	Low Noise, 1.5MHz Regulated Charge Pump White LED Driver	Up to 8 White LEDs, $V_{IN}$ : 2.7V to 4.5V, $V_{OUT(MAX)}$ = 5V, $I_Q$ = 5mA, $I_{SD} \leq 1\mu A$ , 10-Lead MS Package
LTC3205	Multidisplay LED Controller	92% Efficiency, $V_{IN}$ : 2.8V to 4.5V, $I_Q$ = 50µA, $I_{SD} \leq 1\mu A$ , (4mm × 4mm) QFN Package
LTC3206	I <sup>2</sup> C Multidisplay LED Controller	92% Efficiency, 400mA Continuous Output Current. Up to 11 White LEDs in (4mm × 4mm) QFN Package
LTC3208	High Current Software Configurable Multidisplay LED Controller	95% Efficiency, $V_{IN}$ : 2.9V to 4.5V, 1A Output Current, Up to 17 LEDs for 5 Displays, (5mm × 5mm) QFN Package
LTC3214	500mA Camera LED Charge Pump	93% Efficiency, $V_{IN}$ : 2.9V to 4.4V, 1x/1.5x/2x Boost Modes, 3mm × 3mm DFN Package
LTC3215	700mA High Current, Low Noise, White LED Driver	93% Efficiency, $V_{IN}$ : 2.9V to 4.4V, 1x/1.5x/2x Boost Modes, 3mm × 3mm DFN Package
LTC3216	1A High Current, Low Noise, White LED Driver	93% Efficiency, $V_{IN}$ : 2.9V to 4.4V, 1x/1.5x/2x Boost Modes, Independent Low/High Current Programming, 3mm × 4mm DFN Package
LTC3251	500mA ( $I_{OUT}$ ), 1MHz to 1.6MHz Spread Spectrum Step-Down Charge Pump	85% Efficiency, $V_{IN}$ : 3.1V to 5.5V, $V_{OUT}$ : 0.9V to 1.6V, $I_Q$ = 9µA, $I_{SD} \leq 1\mu A$ , 10-Lead MS Package
LTC3405/LTC3405A	300mA ( $I_{OUT}$ ), 1.5MHz Synchronous Step-Down DC/DC Converter	95% Efficiency, $V_{IN}$ : 2.7V to 6V, $V_{OUT(MIN)}$ = 0.8V, $I_Q$ = 20µA, $I_{SD} \leq 1\mu A$ , ThinSOT Package
LTC3406/LTC3406A	600mA ( $I_{OUT}$ ), 1.5MHz Synchronous Step-Down DC/DC Converter	95% Efficiency, $V_{IN}$ : 2.7V to 5.5V, $V_{OUT(MIN)}$ = 0.6V, $I_Q$ = 20µA, $I_{SD} \leq 1\mu A$ , ThinSOT Package

ThinSOT is a trademark of Linear Technology Corporation.

3217fa