

GQM2195C2E3R3CB12#

"#" indicates a package specification code.



< List of part numbers with package codes >
GQM2195C2E3R3CB12D

Shape

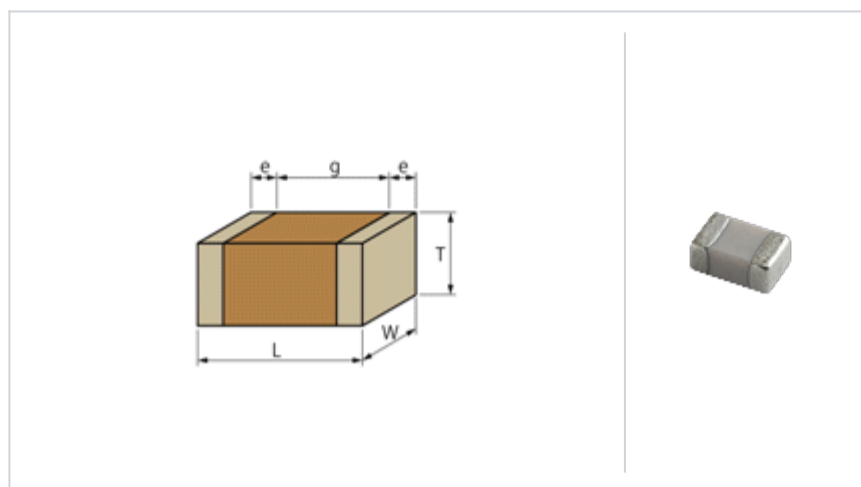

L size	2.0 ± 0.15mm
W size	1.25 ± 0.15mm
T size	0.85 ± 0.15mm
External terminal width e	0.2 to 0.7mm
Distance between external terminals g	0.7mm min.
Size code in inch(mm)	0805 (2012)

References

Packaging	Specifications	Minimum quantity
D	180mm Paper taping	4000

Mass (typ.)	
1 piece	9.5mg
180mm Reel	152g

Specifications

Capacitance	3.3pF ± 0.25pF
Rated voltage	250Vdc
Temperature characteristics (complied standard)	COG(EIA)
Temperature coefficient	0 ± 30ppm/
Temperature range of temperature characteristics	25 to 125
Operating temperature range	-55 to 125

⚠ Attention

- 1.This datasheet is downloaded from the website of Murata Manufacturing Co., Ltd. Therefore, it ' s specifications are subject to change or our products in it may be discontinued without advance notice. Please check with our sales representatives or product engineers before ordering.
- 2.This datasheet has only typical specifications because there is no space for detailed specifications. Therefore, please review our product specifications or consult the approval sheet for product specifications before ordering.

▪ Frequency characteristics (ESR, Impedance)

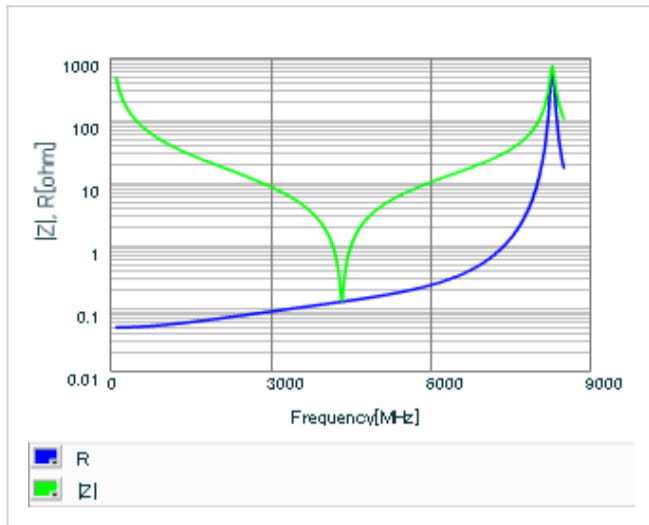

▪ S parameter (Smith chart S11)

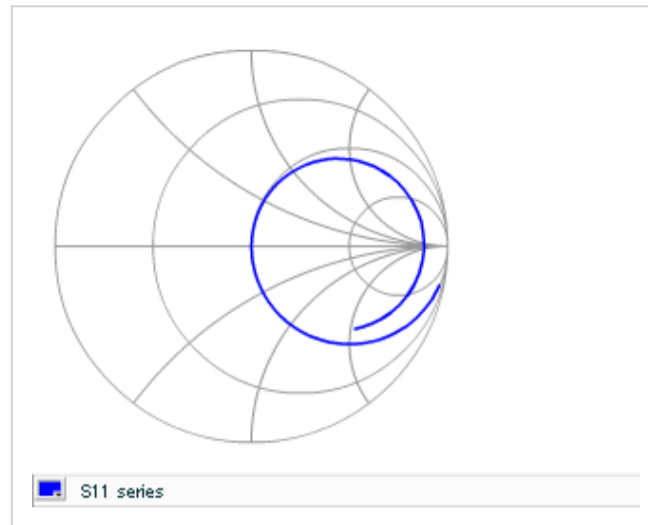

▪ DC bias characteristics

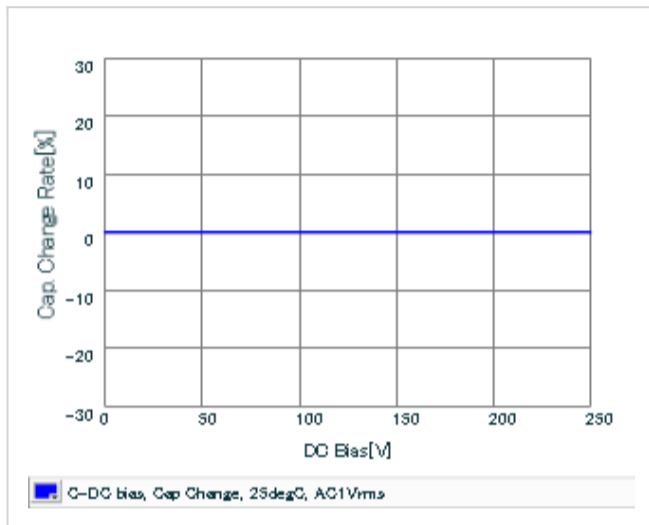

▪ AC voltage characteristics

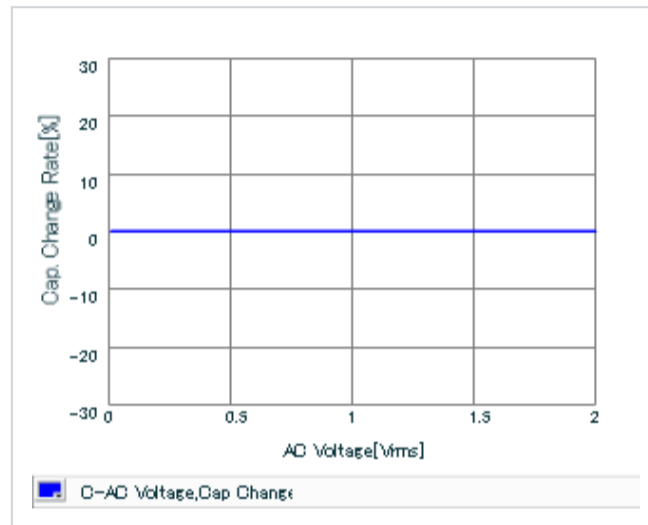

▪ Capacitance - temperature characteristics

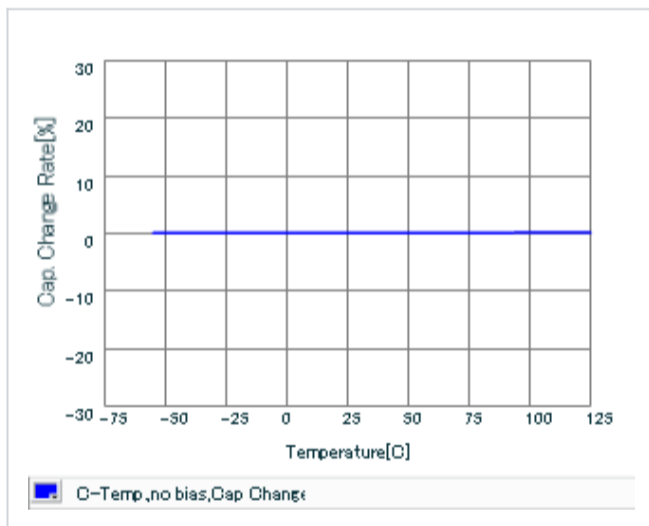

▪ Calorific property by ripple current

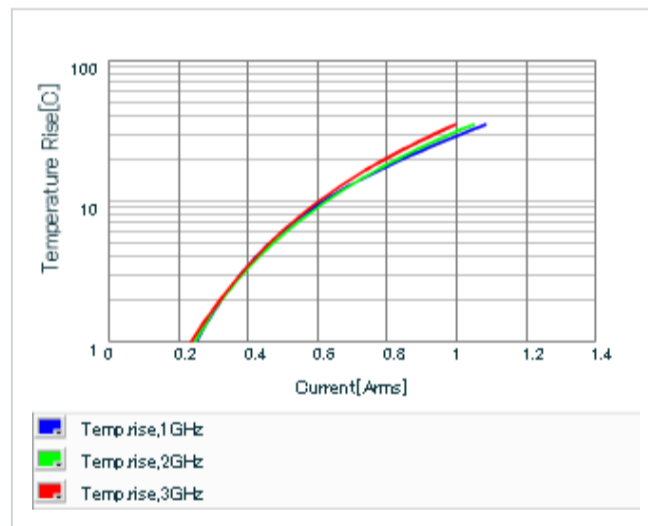

This PDF data has only typical specifications because there is no space for detailed specifications. Therefore, please review our product specifications or consult the approval sheet for product specifications before ordering.