

CSTNE13M0G55A000R0

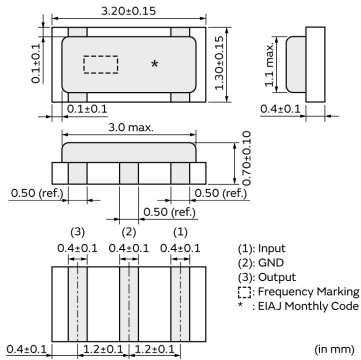

Appearance & Shape



Features

MURATA's package technology expertise has enabled the development of the Chip CERLOCK(R) with built-in load capacitors. This diverse series owes its development to MURATA's original mass production techniques and high reliability, and has achieved importance in the worldwide automotive market.

Features

1. High reliability and available for a wide temperature range.
2. Oscillation circuits do not require external load capacitors.
3. Available for a wide frequency range.
4. Extremely small and have a low profile.
5. No adjustment is necessary for oscillation circuits.
6. Stable supply is ensured due to not using precious metal(Palladium).

Applications

Automotive Usage	Powertrain/Safety
Other Usage	Automotive

Packaging Information

Packaging	Specifications	Standard Packing Quantity
R0	180mm Embossed Tape	3000

Attention
1.This datasheet is downloaded from the website of Murata Manufacturing Co., Ltd. Therefore, it's specifications are subject to change or our products in it may be discontinued without advance notice. Please check with our sales representatives or product engineers before ordering.
2.This datasheet has only typical specifications because there is no space for detailed specifications.
Therefore, please review our product specifications or consult the approval sheet for product specifications before ordering.

CSTNE13M0G55A000R0



Specifications

Product Type	Ceramic Resonator (CERALOCK)
Series	CSTNE_G_A
Frequency	13.000MHz
Frequency Tolerance	+/-0.50% max.
Operating Temperature Range	-40°C~125°C
Frequency Shift by Temperature	+/-0.20% max.
Frequency Aging	+/-0.10% max.
Resonant Impedance (R1)	30ohm max.
Built-in Load Capacitance (CL1/CL2)	33pF
Shape	SMD
Wash	available
L x W (size)	3.2x1.3mm
Mass	10.48mg

Attention

- 1.This datasheet is downloaded from the website of Murata Manufacturing Co., Ltd. Therefore, it's specifications are subject to change or our products in it may be discontinued without advance notice. Please check with our sales representatives or product engineers before ordering.
- 2.This datasheet has only typical specifications because there is no space for detailed specifications. Therefore, please review our product specifications or consult the approval sheet for product specifications before ordering.