

### Radial Lead Type

Series: AD Type : A(Radial Leads)

#### Recommended Applications

Amplifier. CD Player. Hi-Fi VTR. Car Audio. Electric piano

Japan

#### Features

Endurance: 85°C 1000 h, 5 mm height, Newly type electrolytic separator, Clear and speedy sound.

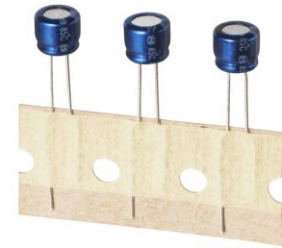

#### Specifications

|                       |  |                                    |
|-----------------------|--|------------------------------------|
| Category temp. range  | -40 to +85°C   |                                    |
| Rated W.V. Range      | 6.3 to 50 V .DC  |                                    |
| Nominal Cap. Range    | 0.1 to 330 μ F   |                                    |
| Capacitance Tolerance | ±20 % (120Hz/+20°C)  |                                    |
| DC Leakage Current    | I ≤ 0.01 CV or 3(μ A) (Whichever is greater)   |                                    |
| Dissipation Factor    | Please see the attached standard products list   |                                    |
| Endurance             | After applying rated working voltage for 1000 hours at +85 ±2°C and then being stabilized at +20°C, capacitor shall meet the following limits.   |                                    |
|                       | Capacitance change   | ± 20% of initial measured value    |
|                       | D.F.   | ≤ 200 % of initial specified value |
|                       | DC leakage current   | ≤ initial specified value          |
| Shelf Life            | After storage for 1000 hours at +85±2 °C with no voltage applied and then being stabilized at +20 °C, capacitors shall meet the limits specified in "Endurance".(With voltage treatment) |                                    |

#### Dimensions in mm (not to scale)

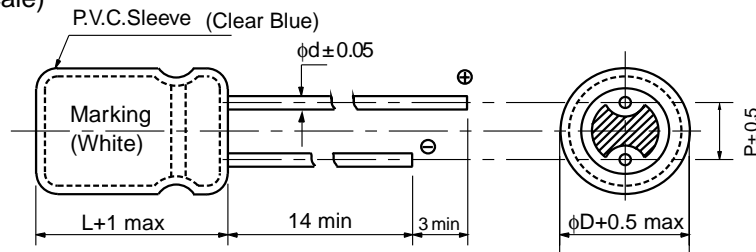

#### Standard Products

| W.V.<br>(V) | Cap.<br>(±20%)<br>(μF) | Case size    |                | Specification                                |      | Lead Length       |                  |                      |                      | Part No.      | Min. Packaging Q'ty     |                 |
|-------------|------------------------|--------------|----------------|--|------|-------------------|------------------|----------------------|----------------------|---------------|-------------------------|-----------------|
|             |                        | Dia.<br>(mm) | Length<br>(mm) | Ripple current<br>(120Hz)<br>(+85°C)<br>(mA) | D.F. | Lead Dia.<br>(mm) | Lead Space       |                      |                      |               | Straight Leads<br>(pcs) | Taping<br>(pcs) |
|             |                        |              |                |  |      |                   | Straight<br>(mm) | Taping<br>*B<br>(mm) | Taping<br>*i<br>(mm) |               |                         |                 |
| 6.3         | 22                     | 4            | 5              | 29   | 0.33 | 0.45              | 1.5              | 5                    | 2.5                  | ECA0JAD220X() | 200                     | 2000            |
|             | 47                     | 5            | 5              | 46   | 0.33 | 0.45              | 2.0              | 5                    | 2.5                  | ECA0JAD470X() | 200                     | 2000            |
|             | 330                    | 8            | 5              | 130  | 0.33 | 0.45              | 2.5              | 5                    |                      | ECA0JAD331X() | 200                     | 1000            |
| 10          | 33                     | 5            | 5              | 43   | 0.25 | 0.45              | 2.0              | 5                    | 2.5                  | ECA1AAD330X() | 200                     | 2000            |
|             | 100                    | 6.3          | 5              | 80   | 0.25 | 0.45              | 2.5              | 5                    | 2.5                  | ECA1AAD101X() | 200                     | 2000            |
|             | 220                    | 8            | 5              | 120  | 0.25 | 0.45              | 2.5              | 5                    |                      | ECA1AAD221X() | 200                     | 1000            |
| 16          | 10                     | 4            | 5              | 28   | 0.20 | 0.45              | 1.5              | 5                    | 2.5                  | ECA1CAD100X() | 200                     | 2000            |
|             | 22                     | 5            | 5              | 39   | 0.20 | 0.45              | 2.0              | 5                    | 2.5                  | ECA1CAD220X() | 200                     | 2000            |
|             | 47                     | 6.3          | 5              | 70   | 0.20 | 0.45              | 2.5              | 5                    | 2.5                  | ECA1CAD470X() | 200                     | 2000            |
|             | 100                    | 8            | 5              | 91   | 0.20 | 0.45              | 2.5              | 5                    |                      | ECA1CAD101X() | 200                     | 1000            |
| 25          | 33                     | 6.3          | 5              | 65   | 0.15 | 0.45              | 2.5              | 5                    | 2.5                  | ECA1EAD330X() | 200                     | 2000            |
| 35          | 4.7                    | 4            | 5              | 22   | 0.12 | 0.45              | 1.5              | 5                    | 2.5                  | ECA1VAD4R7X() | 200                     | 2000            |
|             | 10                     | 5            | 5              | 28   | 0.12 | 0.45              | 2.0              | 5                    | 2.5                  | ECA1VAD100X() | 200                     | 2000            |
|             | 22                     | 6.3          | 5              | 55   | 0.12 | 0.45              | 2.5              | 5                    | 2.5                  | ECA1VAD220X() | 200                     | 2000            |
|             | 33                     | 8            | 5              | 65   | 0.12 | 0.45              | 2.5              | 5                    |                      | ECA1VAD330X() | 200                     | 1000            |
| 50          | 0.1                    | 4            | 5              | 1  | 0.12 | 0.45              | 1.5              | 5                    | 2.5                  | ECA1HAD0R1X() | 200                     | 2000            |
|             | 0.22                   | 4            | 5              | 2  | 0.12 | 0.45              | 1.5              | 5                    | 2.5                  | ECA1HADR22X() | 200                     | 2000            |
|             | 0.33                   | 4            | 5              | 3  | 0.12 | 0.45              | 1.5              | 5                    | 2.5                  | ECA1HADR33X() | 200                     | 2000            |
|             | 0.47                   | 4            | 5              | 5  | 0.12 | 0.45              | 1.5              | 5                    | 2.5                  | ECA1HADR47X() | 200                     | 2000            |
|             | 0.68                   | 4            | 5              | 7  | 0.12 | 0.45              | 1.5              | 5                    | 2.5                  | ECA1HADR68X() | 200                     | 2000            |
|             | 1                      | 4            | 5              | 10   | 0.12 | 0.45              | 1.5              | 5                    | 2.5                  | ECA1HAD010X() | 200                     | 2000            |
|             | 2.2                    | 4            | 5              | 16   | 0.12 | 0.45              | 1.5              | 5                    | 2.5                  | ECA1HAD2R2X() | 200                     | 2000            |
|             | 3.3                    | 4            | 5              | 16   | 0.12 | 0.45              | 1.5              | 5                    | 2.5                  | ECA1HAD3R3X() | 200                     | 2000            |
|             | 4.7                    | 5            | 5              | 23   | 0.12 | 0.45              | 2.0              | 5                    | 2.5                  | ECA1HAD4R7X() | 200                     | 2000            |
|             | 10                     | 6.3          | 5              | 35   | 0.12 | 0.45              | 2.5              | 5                    | 2.5                  | ECA1HAD100X() | 200                     | 2000            |
|             | 22                     | 8            | 5              | 60   | 0.12 | 0.45              | 2.5              | 5                    |                      | ECA1HAD220X() | 200                     | 1000            |

When requesting taped product, please put the letter "B" between the "( )". Lead wire pitch B=5mm, i=2.5mm. The taping dimensions are explained on our Inter-Net Catalog (Taping Spec.). Please use it as a reference guide.

Design, Specifications are subject to change without notice. Ask factory for technical specifications before purchase and/or use. Whenever a doubt about safety arises from this product, please inform us immediately for technical consultation without fail.

Radial Lead Type For Audio( ~ φ18)

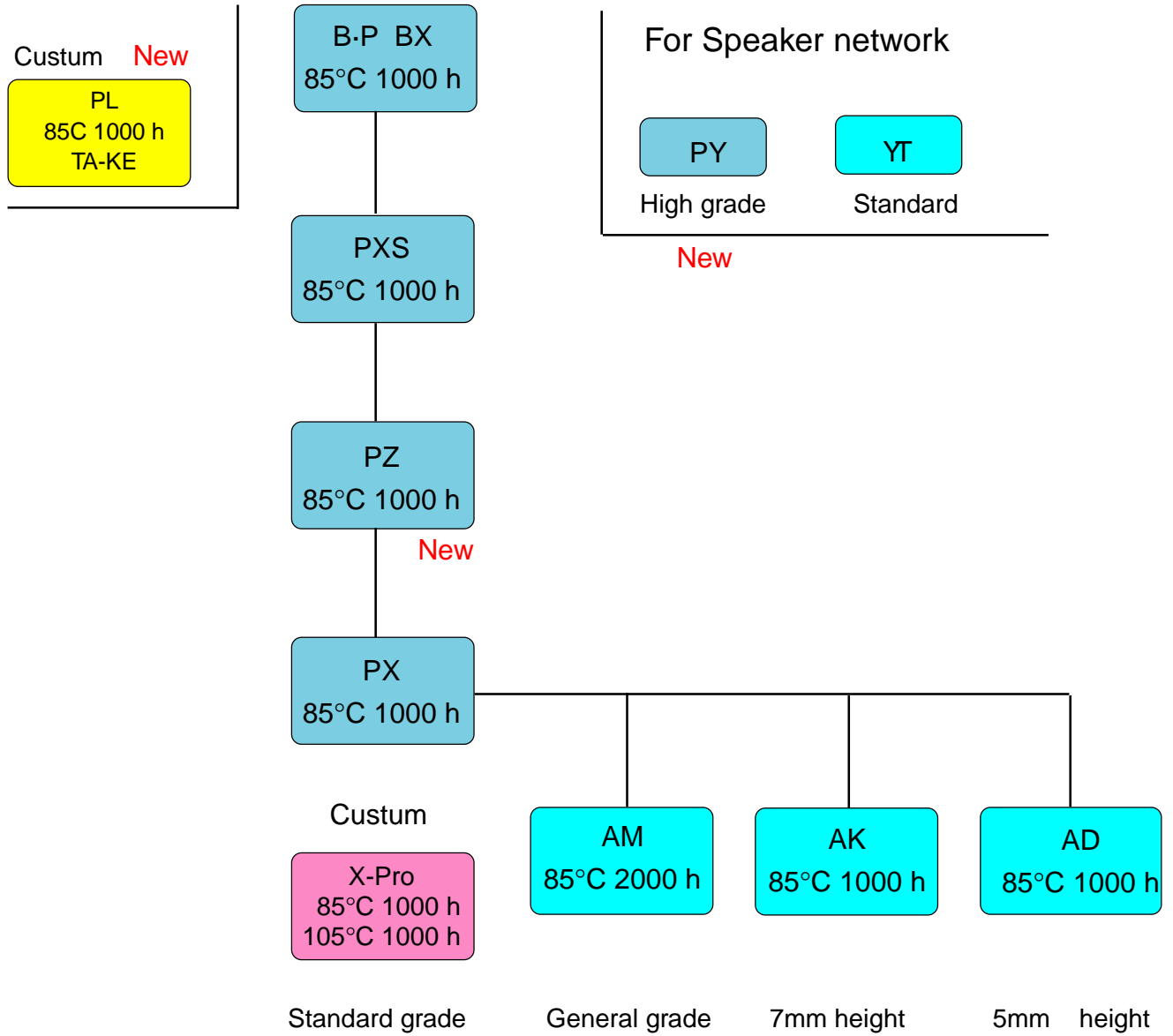

## ⚠ Application Guidelines

### 1. Circuit Design

Ensure that operational and mounting conditions follow the specified conditions detailed in the catalog and specification sheets.

#### 1.1 Operating Temperature and Frequency

Electrolytic capacitor electrical parameters are normally specified at 20°C temperature and 120Hz frequency. These parameters vary with changes in temperature and frequency. Circuit designers should take these changes into consideration.

(1) Effects of operating temperature on electrical parameters

- a) At higher temperatures, leakage current and capacitance increase while equivalent series resistance (ESR) decreases.
- b) At lower temperatures, leakage current and capacitance decrease while equivalent series resistance (ESR) increases.

(2) Effects of frequency on electrical parameters

- a) At higher frequencies, capacitance and impedance decrease while  $\tan \delta$  increases.
- b) At lower frequencies, ripple current generated heat will rise due to an increase in equivalent series resistance (ESR).

### 1.2 Operating Temperature and Life Expectancy

(1) Expected life is affected by operating temperature. Generally, each 10°C reduction in temperature will double the expected life. Use capacitors at the lowest possible temperature below the maximum guaranteed temperature.

(2) If operating conditions exceed the maximum guaranteed limit, rapid electrical parameter deterioration will occur, and irreversible damage will result.

Check for maximum capacitor operating temperatures including ambient temperature, internal capacitor temperature rise caused by ripple current, and the effects of radiated heat from power transistors, IC's or resistors.

Avoid placing components which could conduct heat to the capacitor from the back side of the circuit board.

(3) The formula for calculating expected life at lower operating temperatures is as follows;

$$L_2 = L_1 \times 2^{\frac{T_1 - T_2}{10}} \quad \text{where,}$$

L1: Guaranteed life (h) at temperature, T<sub>1</sub>° C

L2: Expected life (h) at temperature, T<sub>2</sub>° C

T<sub>1</sub>: Maximum operating temperature (°C)

T<sub>2</sub>: Actual operating temperature, ambient temperature + temperature rise due to ripple current heating (°C)

A quick reference capacitor guide for estimating expected life is included for your reference.

### ■ Expected Life Estimate Quick Reference Guide

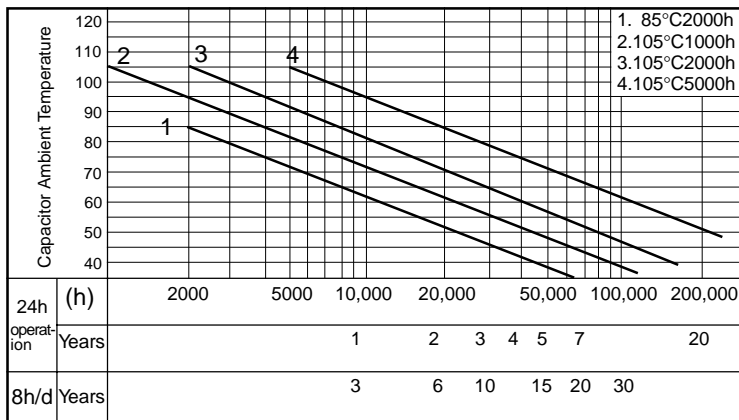

### ■ Failure rate curve

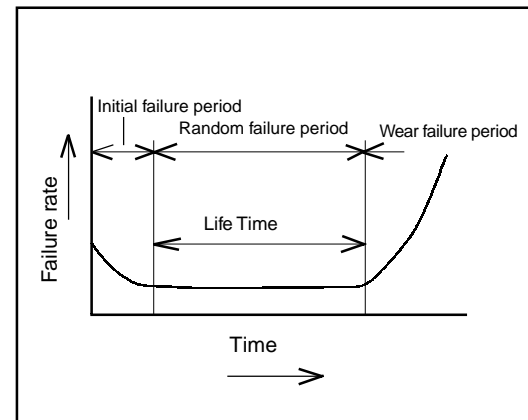

■ Typical failure modes and their factors

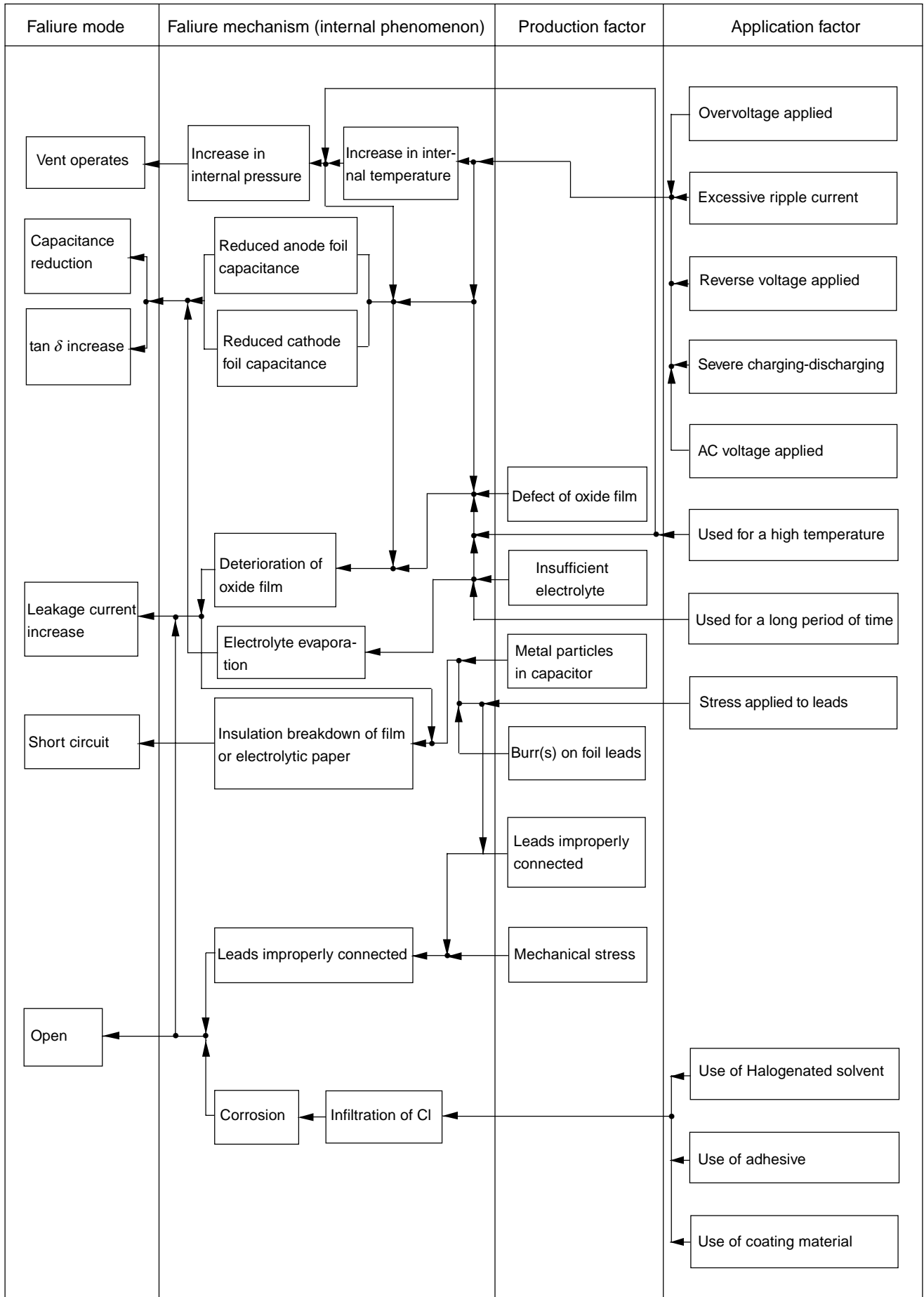

Design, Specifications are subject to change without notice. Ask factory for technical specifications before purchase and/or use. Whenever a doubt about safety arises from this product, please inform us immediately for technical consultation without fail.

### 1.3 Common Application Conditions to Avoid

The following misapplication load conditions will cause rapid deterioration to capacitor electrical parameters. In addition, rapid heating and gas generation within the capacitor can occur causing the pressure relief vent to operate and resultant leakage of electrolyte. Under extreme conditions, explosion and fire could result. Leaking electrolyte is combustible and electrically conductive.

#### (1) Reverse Voltage

DC capacitors have polarity. Verify correct polarity before insertion. For circuits with changing or uncertain polarity, use DC bipolar capacitors. DC bipolar capacitors are not suitable for use in AC circuits.

#### (2) Charge/Discharge Applications

Standard capacitors are not suitable for use in repeating charge/discharge applications. For charge/discharge applications consult us and advise actual conditions.

#### (3) Overvoltage

Do not apply voltages exceeding the maximum specified rated voltages. Voltage up to the surge voltage rating are acceptable for short periods of time. Ensure that the sum of the DC voltage and the superimposed AC ripple voltage does not exceed the rated voltage.

#### (4) Ripple Current

Do not apply ripple currents exceeding the maximum specified value. For high ripple current applications, use a capacitor designed for high ripple currents or contact us with your requirements.

Ensure that allowable ripple currents superimposed on low DC bias voltages do not cause reverse voltage conditions.

### 1.4 Using Two or More Capacitors in Series or Parallel

#### (1) Capacitors Connected in Parallel

The circuit resistance can closely approximate the series resistance of the capacitor causing an imbalance of ripple current loads within the capacitors. Careful design of wiring methods can minimize the possibility of excessive ripple currents applied to a capacitor.

#### (2) Capacitors Connected in Series

Normal DC leakage current differences among capacitors can cause voltage imbalances. The use of voltage divider shunt resistors with consideration to leakage currents, can prevent capacitor voltage imbalances.

### 1.5 Capacitor Mounting Considerations

#### (1) Double - Sided Circuit Boards

Avoid wiring Pattern runs which pass between the mounted capacitor and the circuit board. When dipping into a solder bath, excess solder may collect under the capacitor by capillary action and shortcircuit the anode and cathode terminals.

#### (2) Circuit Board Hole Positioning

The vinyl sleeve of the capacitor can be damaged if solder passes through a lead hole for subsequently processed parts. Special care when locating hole positions in proximity to capacitors is recommended.

#### (3) Circuit Board Hole Spacing

The circuit board holes spacing should match the capacitor lead wire spacing within the specified tolerances. Incorrect spacing can cause excessive lead wire stress during the insertion process. This may result in premature capacitor failure due to short or open circuit, increased leakage current, or electrolyte leakage.

#### (4) Land/Pad Pattern

The circuit board land/pad pattern size for chip capacitors is specified in the following table.

[ Table of Board Land Size vs. Capacitor Size ]

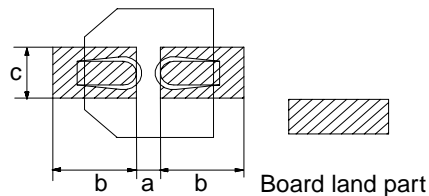

| Size                        | a   | b   | c   |
|-----------------------------|-----|-----|-----|
| A( $\phi 3$ )               | 0.6 | 2.2 | 1.5 |
| B( $\phi 4$ )               | 1.0 | 2.5 | 1.6 |
| C( $\phi 5$ )               | 1.5 | 2.8 | 1.6 |
| D( $\phi 6.3$ )             | 1.8 | 3.2 | 1.6 |
| E( $\phi 8 \times 6.2L$ )   | 2.2 | 4.0 | 1.6 |
| F( $\phi 8 \times 10.2L$ )  | 3.1 | 4.0 | 2.0 |
| G( $\phi 10 \times 10.2L$ ) | 4.6 | 4.1 | 2.0 |

Among others, when the size a is wide, back fillet can not be made, decreasing fitting strength.

※ Decide considering mounting condition, solderability and fitting strength, etc. based on the design standards of your company.

## (5) Clearance for Case Mounted Pressure Relief Vents

Capacitors with case mounted pressure relief vents require sufficient clearance to allow for proper vent operation. The minimum clearances are dependent on capacitor diameters as follows.

- φ6.3 to φ16 mm : 2 mm minimum,
- φ18 to φ35 mm : 3 mm minimum.
- φ40 mm or greater: 5 mm minimum

## (6) Clearance for Seal Mounted Pressure Relief Vents

A hole in the circuit board directly under the seal vent location is required to allow proper release of pressure.

## (7) Wiring Near the Pressure Relief Vent

Avoid locating high voltage or high current wiring or circuit board paths above the pressure relief vent. Flammable, high temperature gas exceeding 100°C may be released which could dissolve the wire insulation and ignite.

## (8) Circuit Board Patterns Under the Capacitor

Avoid circuit board runs under the capacitor as electrolyte leakage could cause an electrical short.

## (9) Screw Terminal Capacitor Mounting

- Do not orient the capacitor with the screw terminal side of the capacitor facing downwards.
- Tighten the terminal and mounting bracket screws within the torque range specified in the specification.

## 1.6 Electrical Isolation of the Capacitor

Completely isolate the capacitor as follows.

- Between the cathode and the case (except for axially leaded B types) and between the anode terminal and other circuit paths.
- Between the extra mounting terminals (on T types) and the anode terminal, cathode terminal, and other circuit paths.

## 1.7 Capacitor Sleeve

The vinyl sleeve or laminate coating is intended for marking and identification purposes and is not meant to electrically insulate the capacitor.

The sleeving may split or crack if immersed into solvents such as toluene or xylene, and then exposed to high temperatures.

Always consider safety when designing equipment and circuits. Plan for worst case failure modes such as short circuits and open circuits which could occur during use.

- (1) Provide protection circuits and protection devices to allow safe failure modes.
- (2) Design redundant or secondary circuits where possible to assure continued operation in case of main circuit failure.

## 2. Capacitor Handling Techniques

### 2.1 Considerations Before Using

- (1) Capacitors have a finite life. Do not reuse or recycle capacitors from used equipment.
- (2) Transient recovery voltage may be generated in the capacitor due to dielectric absorption. If required, this voltage can be discharged with a resistor with a value of about 1 kΩ.
- (3) Capacitors stored for long periods of time may exhibit an increase in leakage current. This can be corrected by gradually applying rated voltage in series with a resistor of approximately 1 kΩ.
- (4) If capacitors are dropped, they can be damaged mechanically or electrically. Avoid using dropped capacitors.
- (5) Dented or crushed capacitors should not be used. The seal integrity can be compromised and loss of electrolyte/shortened life can result.

### 2.2 Capacitor Insertion

- (1) Verify the correct capacitance and rated voltage of the capacitor.
- (2) Verify the correct polarity of the capacitor before inserting.
- (3) Verify the correct hole spacing before insertion (land pattern size on chip type) to avoid stress on the terminals.
- (4) Ensure that the auto insertion equipment lead clinching operation does not stress the capacitor leads where they enter the seal of the capacitor. For chip type capacitors, excessive mounting pressure can cause high leakage current, short circuit, or disconnection.

### 2.3 Manual Soldering

- (1) Observe temperature and time soldering specifications or do not exceed temperatures of 350°C for 3 seconds or less.
- (2) If lead wires must be formed to meet terminal board hole spacing, avoid stress on the leadwire where it enters the capacitor seal.
- (3) If a soldered capacitor must be removed and reinserted, avoid excessive stress to the capacitor leads.
- (4) Avoid touching the tip of the soldering iron to the capacitor, to prevent melting of the vinyl sleeve.



## 2.4 Flow Soldering

- (1) Do not immerse the capacitor body into the solder bath as excessive internal pressure could result.
- (2) Observe proper soldering conditions (temperature, time, etc.). Do not exceed the specified limits.
- (3) Do not allow other parts or components to touch the capacitor during soldering.

## 2.5 Reflow Soldering for Chip Capacitors

- (1) For reflow, use a thermal conduction system such as infrared radiation (IR) or hot blast. Vapor heat transfer systems (VPS) are not recommended.
- (2) Observe proper soldering conditions (temperature, time, etc.). Do not exceed the specified limits.
- (3) Reflow should be performed one time. Consult us for additional reflow restrictions.

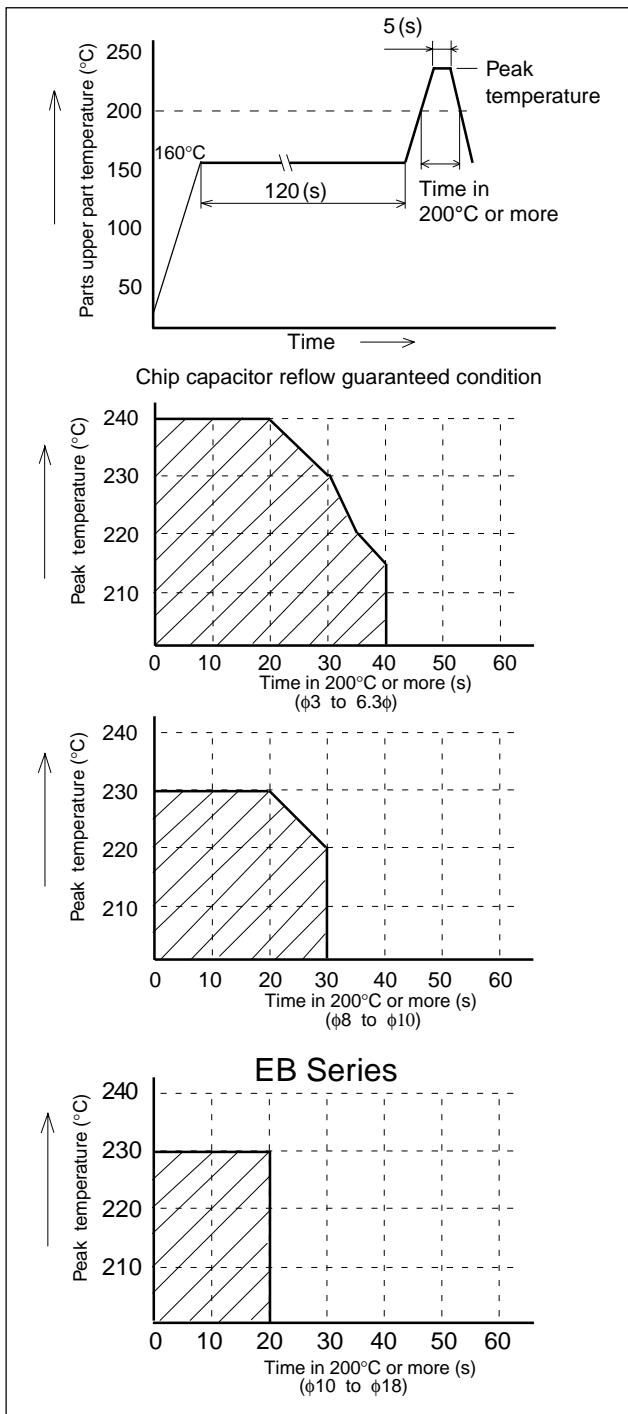

## 2.6 Other Soldering Considerations

Rapid temperature rises during the preheat operation and resin bonding operation can cause cracking of the capacitor vinyl sleeve. For heat curing, do not exceed 150°C for a maximum time of 2 minutes.

## 2.7 Capacitor Handling after Soldering

- (1) Avoid movement of the capacitor after soldering to prevent excessive stress on the leadwires where they enter the seal.
- (2) Do not use the capacitor as a handle when moving the circuit board assembly.
- (3) Avoid striking the capacitor after assembly to prevent failure due to excessive shock.

## 2.8 Circuit Board Cleaning

- (1) Circuit boards can be immersed or ultrasonically cleaned using suitable cleaning solvents for up to 5 minutes and up to 60°C maximum temperatures. The boards should be thoroughly rinsed and dried.

Recommended cleaning solvents include Pine Alpha ST-100S, Sunelec B-12, DK Beclear CW-5790, Aqua Cleaner 210SEP, Cold Cleaner P3-375, Telpen Cleaner EC-7R, Clean-thru 750H, Clean-thru 750L, Clean thru 710M, Techno Cleaner 219, Techno Care FRW-17, Techno Care FRW-1, Techno Care FRV-1, IPA (isopropyl alcohol)

\* The use of ozone depleting cleaning agents are not recommended in the interest of protecting the environment.

- (2) Avoid using the following solvent groups unless specifically allowed for in the specification;

- Halogenated cleaning solvents: except for solvent resistant capacitor types, halogenated solvents can permeate the seal and cause internal capacitor corrosion and failure. For solvent resistant capacitors, carefully follow the temperature and time requirements of the specification. 1-1-1 trichloroethane should never be used on any aluminium electrolytic capacitor.
- Alkali solvents: could attack and dissolve the aluminum case.
- Petroleum based solvents: deterioration of the rubber seal could result.
- Xylene: deterioration of the rubber seal could result.
- Acetone: removal of the ink markings on the vinyl sleeve could result.

\* Temperature measuring method: Measure temperature in assuming quantitative production, by sticking the thermo-couple to the capacitor upper part with epoxy adhesives.

Design, Specifications are subject to change without notice. Ask factory for technical specifications before purchase and/or use. Whenever a doubt about safety arises from this product, please inform us immediately for technical consultation without fail.

- (3) A thorough drying after cleaning is required to remove residual cleaning solvents which may be trapped between the capacitor and the circuit board. Avoid drying temperatures which exceed the maximum rated temperature of the capacitor.
- (4) Monitor the contamination levels of the cleaning solvents during use by electrical conductivity, pH, specific gravity, or water content. Chlorine levels can rise with contamination and adversely affect the performance of the capacitor.

\* Please consult us for additional information about acceptable cleaning solvents or cleaning methods.

| Type               | Series              | Cleaning permitted |
|--------------------|---------------------|--------------------|
| Surface mount type | V(Except EB Series) | ○                  |
| Lead type          | Bi-polar SU         | ○                  |
|                    | M                   | ○(~ 100V)          |
|                    | KA                  | ○                  |
|                    | Bi-polar KA         | ○                  |
|                    | FB                  | ○                  |
|                    | FC                  | ○                  |
|                    | GA                  | ○                  |
|                    | NHG                 | ○(~ 100V)          |
|                    | EB                  | ○(~ 100V)          |
| Snap-in type       | TA                  | ○                  |
|                    | TS UP               | ○(~ 100V)          |
|                    | TS HA               | ○(~ 100V)          |

## 2.9 Mounting Adhesives and Coating Agents

When using mounting adhesives or coating agents to control humidity, avoid using materials containing halogenated solvents. Also, avoid the use of chloroprene based polymers.

\* After applying adhesives or coatings, dry thoroughly to prevent residual solvents from being trapped between the capacitor and the circuit board.

## 3. Precautions for using capacitors

### 3.1 Environmental Conditions

Capacitors should not be used in the following environments.

- (1) Temperature exposure above the maximum rated or below the minimum rated temperature of the capacitor.
- (2) Direct contact with water, salt water, or oil.
- (3) High humidity conditions where water could condense on the capacitor.
- (4) Exposure to toxic gases such as hydrogen sulfide, sulfuric acid, nitric acid, chlorine, or ammonia.
- (5) Exposure to ozone, radiation, or ultraviolet rays.
- (6) Vibration and shock conditions exceeding specified requirements.

### 3.2 Electrical Precautions

- (1) Avoid touching the terminals of the capacitor as possible electric shock could result. The exposed aluminium case is not insulated and could also cause electric shock if touched.
- (2) Avoid short circuiting the area between the capacitor terminals with conductive materials including liquids such as acids or alkaline solutions.

## 4. Emergency Procedures

- (1) If the pressure relief vent of the capacitor operates, immediately turn off the equipment and disconnect from the power source. This will minimize additional damage caused by the vaporizing electrolyte.
- (2) Avoid contact with the escaping electrolyte gas which can exceed 100°C temperatures. If electrolyte or gas enters the eye, immediately flush the eye with large amounts of water. If electrolyte or gas is ingested by mouth, gargle with water. If electrolyte contacts the skin, wash with soap and water.

## 5. Long Term Storage

Leakage current of a capacitor increases with long storage times. The aluminium oxide film deteriorates as a function of temperature and time. If used without reconditioning, an abnormally high current will be required to restore the oxide film. This current surge could cause the circuit or the capacitor to fail. Capacitor should be reconditioned by applying rated voltage in series with a 1000 Ω, current limiting resistor for a time period of 30 minutes.

### 5.1 Environmental Conditions (Storage)

Capacitors should not be stored in the following environments.

- (1) Temperature exposure above 35°C or below 15 °C.
- (2) Direct contact with water, salt water, or oil.
- (3) High humidity conditions where water could condense on the capacitor.
- (4) Exposure to toxic gases such as hydrogen sulfide, sulfuric acid, nitric acid, chlorine, or ammonia.
- (5) Exposure to ozone, radiation, or ultraviolet rays.
- (6) Vibration and shock conditions exceeding specified requirements.



### 6. Capacitor Disposal

When disposing of capacitors, use one of the following methods.

- Incinerate after crushing the capacitor or puncturing the can wall (to prevent explosion due to internal pressure rise). Capacitors should be incinerated at high temperatures to prevent the release of toxic gases such as chlorine from the polyvinyl chloride sleeve, etc.
- Dispose of as solid waste.
- Local laws may have specific disposal requirements which must be followed.

The application guidelines above are taken from:

Technical Report EIAJ RCR-2367 issued by the Japan Electronic Industry Association, Inc. -  
Guideline of notabilia for aluminium electrolytic capacitors with non-solid electrolytic for use in electronic equipment.

Refer to this Technical Report for additional details.