

Radiation Tolerant 20-Bit, 1MSPS, Low Power Plastic Package SAR ADC

FEATURES

- 10kRad (Si) Total Ionizing Dose (TID) per MIL-STD-883 TM1019 Condition A
- Single Event Latch-Up (SEL) Threshold Linear Energy Transfer (LET) $\geq 30.86\text{MeV}\cdot\text{cm}^2/\text{mg}$ at $T_{\text{CASE}} = 70^\circ\text{C}$
- Processed Using MIL-PRF-38535 Class N and PEM-INST-001 as a Guideline
- TID and SEL Reports Available
- 1MSPS Throughput Rate
- $\pm 0.5\text{ppm}$ INL (Typ)
- Guaranteed 20-Bit No Missing Codes
- Low Power: 21mW at 1MSPS, 21 μW at 1kSPS
- 104dB SNR (Typ) at $f_{\text{IN}} = 2\text{kHz}$
- -125dB THD (Typ) at $f_{\text{IN}} = 2\text{kHz}$
- Digital Gain Compression (DGC)
- 2.5V Supply
- Fully Differential Input Range $\pm V_{\text{REF}}$
- V_{REF} Input Range from 2.5V to 5.1V
- No Pipeline Delay, No Cycle Latency
- 1.8V to 5V I/O Voltages
- SPI-Compatible Serial I/O with Daisy-Chain Mode
- Internal Conversion Clock
- 16-Lead MSOP Package

DESCRIPTION

The RT2378-20 is a low noise, low power, high speed 20-bit successive approximation register (SAR) ADC. Operating from a 2.5V supply, the RT2378-20 has a $\pm V_{\text{REF}}$ fully differential input range with V_{REF} ranging from 2.5V to 5.1V. The RT2378-20 consumes only 21mW and achieves $\pm 2\text{ppm}$ INL maximum, no missing codes at 20 bits with 104dB SNR.

The RT2378-20 has a high speed SPI-compatible serial interface that supports 1.8V, 2.5V, 3.3V and 5V logic while also featuring a daisy-chain mode. The fast 1MSPS throughput with no cycle latency makes the RT2378-20 ideally suited for a wide variety of high speed applications. An internal oscillator sets the conversion time, easing external timing considerations. The RT2378-20 automatically powers down between conversions, leading to reduced power dissipation that scales with the sampling rate.

The RT2378-20 features a unique digital gain compression (DGC) function, which eliminates the driver amplifier's negative supply while preserving the full resolution of the ADC. When enabled, the ADC performs a digital scaling function that maps zero-scale code from 0V to $0.1 \cdot V_{\text{REF}}$ and full-scale code from V_{REF} to $0.9 \cdot V_{\text{REF}}$. For a typical reference voltage of 5V, the full-scale input range is now 0.5V to 4.5V, which provides adequate headroom for powering the driving amplifier from a single 5.5V supply.

LT, LTC, LTM, Linear Technology and the Linear logo are registered trademarks and SoftSpan is a trademark of Analog Devices, Inc. All other trademarks are the property of their respective owners. Patents Pending. Protected by U.S. Patents, including 7705765, 7961132, 8319673.

TYPICAL APPLICATION

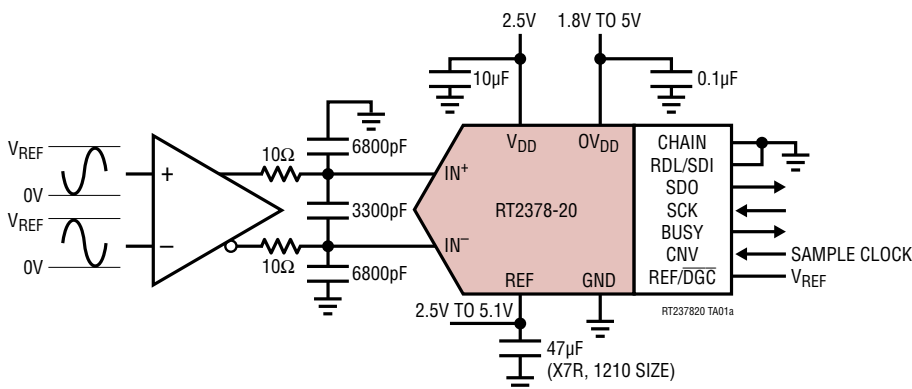

Integral Nonlinearity vs Output Code

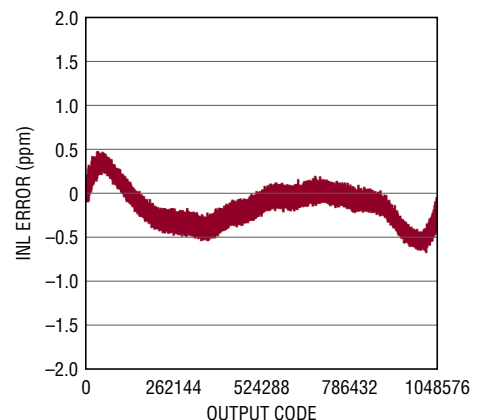

rt237820fa

RT2378-20

ABSOLUTE MAXIMUM RATINGS

(Notes 1, 2)

Supply Voltage (V_{DD})	2.8V	Digital Output Voltage	
Supply Voltage (OV_{DD})	6V	(Note 3)	(GND - 0.3V) to ($OV_{DD} + 0.3V$)
Reference Input (REF)	6V	Operating Temperature Range	
Analog Input Voltage (Note 3)		RT2378I	-40°C to 85°C
IN ⁺ , IN ⁻	(GND - 0.3V) to (REF + 0.3V)	Storage Temperature Range	-65°C to 150°C
REF/DGC Input (Note 3)	(GND - 0.3V) to (REF + 0.3V)		
Digital Input Voltage			
(Note 3)	(GND - 0.3V) to ($OV_{DD} + 0.3V$)		

PIN CONFIGURATION

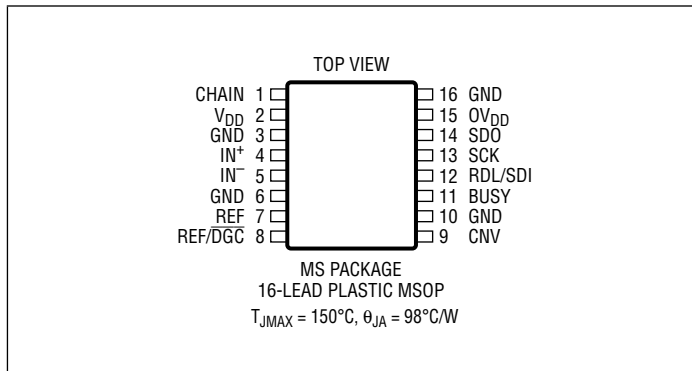

ORDER INFORMATION

LEAD FINISH	TAPE AND REEL	PART MARKING	PACKAGE DESCRIPTION	TEMPERATURE RANGE
RT2378IMS-20	RT2378IMS-20#TR	237820	16-Lead Plastic MSOP	-40°C to 85°C

Consult LTC Marketing for parts specified with wider operating temperature ranges.

For more information on lead free part marking, go to: <http://www.linear.com/leadfree/>

For more information on tape and reel specifications, go to: <http://www.linear.com/tapeandree/>. Some packages are available in 500 unit reels through designated sales channels with #TRMPBF suffix.

ELECTRICAL CHARACTERISTICS

The ● denotes the specifications which apply over the full operating temperature range, otherwise specifications are at $T_A = 25^\circ\text{C}$. (Note 4)

SYMBOL	PARAMETER	CONDITIONS	SUB GROUP	MIN	TYP	MAX	UNITS
V_{IN+}	Absolute Input Range (IN ⁺)	(Note 5)	● 1, 2, 3	-0.1		$V_{REF} + 0.1$	V
V_{IN-}	Absolute Input Range (IN ⁻)	(Note 5)	● 1, 2, 3	-0.1		$V_{REF} + 0.1$	V
$V_{IN+} - V_{IN-}$	Input Differential Voltage Range	$V_{IN} = V_{IN+} - V_{IN-}$	● 1, 2, 3	$-V_{REF}$		$+V_{REF}$	V
V_{CM}	Common-Mode Input Range		● 1, 2, 3	$V_{REF}/2 - 0.1$	$V_{REF}/2$	$V_{REF}/2 + 0.1$	V
I_{IN}	Analog Input Leakage Current				0.01		μA
C_{IN}	Analog Input Capacitance	Sample Mode Hold Mode			45 5		pF pF
CMRR	Input Common Mode Rejection Ratio	$f_{IN} = 500\text{kHz}$			86		dB

rt237820fa

CONVERTER CHARACTERISTICS

The ● denotes the specifications which apply over the full operating temperature range, otherwise specifications are at $T_A = 25^\circ\text{C}$. (Note 4)

SYMBOL	PARAMETER	CONDITIONS		SUB GROUP	MIN	TYP	MAX	UNITS
	Resolution		●		20			Bits
	No Missing Codes		●		20			Bits
	Transition Noise					2.3		ppm _{RMS}
INL	Integral Linearity Error	(Note 6)	●	1, 2, 3	-2	±0.5	2	ppm
		REF/DG $\overline{\text{C}}$ = GND (Note 6)	●	1, 2, 3	-2	±0.5	2	ppm
DNL	Differential Linearity Error	(Note 10)	●	1, 2, 3	-0.5	±0.2	0.5	ppm
BZE	Bipolar Zero-Scale Error	(Note 7)	●	1, 2, 3	-13	0	13	ppm
						±7		ppb/ $^\circ\text{C}$
FSE	Bipolar Full-Scale Error	(Note 7)	●	1, 2, 3	-100	±10	100	ppm
						±0.05		ppm/ $^\circ\text{C}$

DYNAMIC ACCURACY

The ● denotes the specifications which apply over the full operating temperature range, otherwise specifications are at $T_A = 25^\circ\text{C}$ and $A_{IN} = -1\text{dBFS}$. (Notes 4, 8)

SYMBOL	PARAMETER	CONDITIONS		SUB GROUP	MIN	TYP	MAX	UNITS
SINAD	Signal-to-(Noise + Distortion) Ratio	$f_{IN} = 2\text{kHz}$, $V_{REF} = 5\text{V}$	●	4, 5, 6	101	104		dB
SNR	Signal-to-Noise Ratio	$f_{IN} = 2\text{kHz}$, $V_{REF} = 5\text{V}$	●	4, 5, 6	101	104		dB
		$f_{IN} = 2\text{kHz}$, $V_{REF} = 5\text{V}$, REF/DG $\overline{\text{C}}$ = GND	●	4, 5, 6	99	102		dB
		$f_{IN} = 2\text{kHz}$, $V_{REF} = 2.5\text{V}$	●	4, 5, 6	95.4	98		dB
THD	Total Harmonic Distortion	$f_{IN} = 2\text{kHz}$, $V_{REF} = 5\text{V}$	●	4, 5, 6		-125	-114	dB
		$f_{IN} = 2\text{kHz}$, $V_{REF} = 5\text{V}$, REF/DG $\overline{\text{C}}$ = GND	●	4, 5, 6		-125	-114	dB
		$f_{IN} = 2\text{kHz}$, $V_{REF} = 2.5\text{V}$	●	4, 5, 6		-123	-113	dB
SFDR	Spurious Free Dynamic Range	$f_{IN} = 2\text{kHz}$, $V_{REF} = 5\text{V}$	●	4, 5, 6	115	128		dB
	-3dB Input Bandwidth					34		MHz
	Aperture Delay					500		ps
	Aperture Jitter					4		ps
	Transient Response	Full-Scale Step					312	ns

REFERENCE INPUT

The ● denotes the specifications which apply over the full operating temperature range, otherwise specifications are at $T_A = 25^\circ\text{C}$. (Note 4)

SYMBOL	PARAMETER	CONDITIONS		SUB GROUP	MIN	TYP	MAX	UNITS
V_{REF}	Reference Voltage	(Note 5)	●	1, 2, 3	2.5		5.1	V
I_{REF}	Reference Input Current	(Note 9)	●	1, 2, 3		0.94	1.1	mA
$V_{IHDG\overline{\text{C}}}$	High Level Input Voltage REF/DG $\overline{\text{C}}$ Pin		●	1, 2, 3	$0.8V_{REF}$			V
$V_{ILDG\overline{\text{C}}}$	Low Level Input Voltage REF/DG $\overline{\text{C}}$ Pin		●	1, 2, 3			$0.2V_{REF}$	V

DIGITAL INPUTS AND DIGITAL OUTPUTS

The ● denotes the specifications which apply over the full operating temperature range, otherwise specifications are at $T_A = 25^\circ\text{C}$. (Note 4)

SYMBOL	PARAMETER	CONDITIONS		SUB GROUP	MIN	TYP	MAX	UNITS
V_{IH}	High Level Input Voltage		●	1, 2, 3	$0.8 \cdot OV_{DD}$			V
V_{IL}	Low Level Input Voltage		●	1, 2, 3			$0.2 \cdot OV_{DD}$	V
I_{IN}	Digital Input Current	$V_{IN} = 0V$ to OV_{DD}	●	1, 2, 3	-10		10	μA
C_{IN}	Digital Input Capacitance					5		pF
V_{OH}	High Level Output Voltage	$I_O = -500\mu\text{A}$	●	1, 2, 3	$OV_{DD} - 0.2$			V
V_{OL}	Low Level Output Voltage	$I_O = 500\mu\text{A}$	●	1, 2, 3			0.2	V
I_{OZ}	Hi-Z Output Leakage Current	$V_{OUT} = 0V$ to OV_{DD}	●	1, 2, 3	-10		10	μA
I_{SOURCE}	Output Source Current	$V_{OUT} = 0V$				-10		mA
I_{SINK}	Output Sink Current	$V_{OUT} = OV_{DD}$				10		mA

POWER REQUIREMENTS

The ● denotes the specifications which apply over the full operating temperature range, otherwise specifications are at $T_A = 25^\circ\text{C}$. (Note 4)

SYMBOL	PARAMETER	CONDITIONS		SUB GROUP	MIN	TYP	MAX	UNITS
V_{DD}	Supply Voltage		●	1, 2, 3	2.375	2.5	2.625	V
OV_{DD}	Supply Voltage		●	1, 2, 3	1.71		5.25	V
I_{VDD}	Supply Current	1Msps Sample Rate	●	1, 2, 3		8.4	10	mA
I_{OVDD}	Supply Current	1Msps Sample Rate ($C_L = 20\text{pF}$)				0.2		mA
I_{PD}	Power Down Mode	Conversion Done ($I_{VDD} + I_{OVDD} + I_{REF}$)	●	1, 2, 3		1	90	μA
P_D	Power Dissipation	1Msps Sample Rate		1		21	25	mW
	Power Down Mode	Conversion Done ($I_{VDD} + I_{OVDD} + I_{REF}$)		1		2.5	225	μW

ADC TIMING CHARACTERISTICS

The ● denotes the specifications which apply over the full operating temperature range, otherwise specifications are at $T_A = 25^\circ\text{C}$. (Note 4)

SYMBOL	PARAMETER	CONDITIONS		SUB GROUP	MIN	TYP	MAX	UNITS
f_{SAMPL}	Maximum Sampling Frequency		●	9, 10, 11			1	Msps
t_{CONV}	Conversion Time		●	9, 10, 11	615		675	ns
t_{ACQ}	Acquisition Time	$t_{ACQ} = t_{CYC} - t_{CONV} - t_{BUSYLH}$ (Note 10)	●		312			ns
t_{CYC}	Time Between Conversions		●	9, 10, 11	1			μs
t_{CNVH}	CNV High Time		●	9, 10, 11	20			ns
t_{BUSYLH}	CNV \uparrow to BUSY Delay	$C_L = 20\text{pF}$	●	9, 10, 11			13	ns
t_{CNVL}	Minimum Low Time for CNV	(Note 11)	●	9, 10, 11	20			ns
t_{QUIET}	SCK Quiet Time from CNV \uparrow	(Note 10)	●		20			ns
t_{SCK}	SCK Period	(Notes 11, 12)	●	9, 10, 11	10			ns
t_{SCKH}	SCK High Time		●	9, 10, 11	4			ns
t_{SCKL}	SCK Low Time		●	9, 10, 11	4			ns
$t_{SSDISCK}$	SDI Setup Time From SCK \uparrow	(Note 11)	●	9, 10, 11	4			ns
$t_{HSDISCK}$	SDI Hold Time From SCK \uparrow	(Note 11)	●	9, 10, 11	1			ns
t_{SCKCH}	SCK Period in Chain Mode	$t_{SCKCH} = t_{SSDISCK} + t_{DSDO}$ (Note 11)	●	9, 10, 11	13.5			ns

ADC TIMING CHARACTERISTICS The ● denotes the specifications which apply over the full operating temperature range, otherwise specifications are at T_A = 25°C. (Note 4)

SYMBOL	PARAMETER	CONDITIONS	SUB GROUP	MIN	TYP	MAX	UNITS
t _{DSDO}	SDO Data Valid Delay from SCK↑	C _L = 20pF, OV _{DD} = 5.25V	● 9, 10, 11			7.5	ns
		C _L = 20pF, OV _{DD} = 2.5V	● 9, 10, 11			8	ns
		C _L = 20pF, OV _{DD} = 1.71V	● 9, 10, 11			9.5	ns
t _{HSDO}	SDO Data Remains Valid Delay from SCK↑	C _L = 20pF (Note 10)	●	1			ns
t _{DSDOBUSYL}	SDO Data Valid Delay from BUSY↓	C _L = 20pF (Note 10)	●			5	ns
t _{EN}	Bus Enable Time After RDL↓	(Note 11)	● 9, 10, 11			16	ns
t _{DIS}	Bus Relinquish Time After RDL↑	(Note 11)	● 9, 10, 11			13	ns

CONVERTER CHARACTERISTICS (Post-Irradiation) The ● denotes the specifications which apply over the full operating temperature range, otherwise specifications are at T_A = 25°C. (Note 4)

SYMBOL	PARAMETER	CONDITIONS	10kRAD(SI)			UNITS
			MIN	TYP	TYP	
INL	Integral Linearity Error	(Note 6) REF/DGC = GND (Note 6)	-3.5		3.5	ppm
			-3.5		3.5	ppm

TOTAL DOSE BIAS CIRCUIT

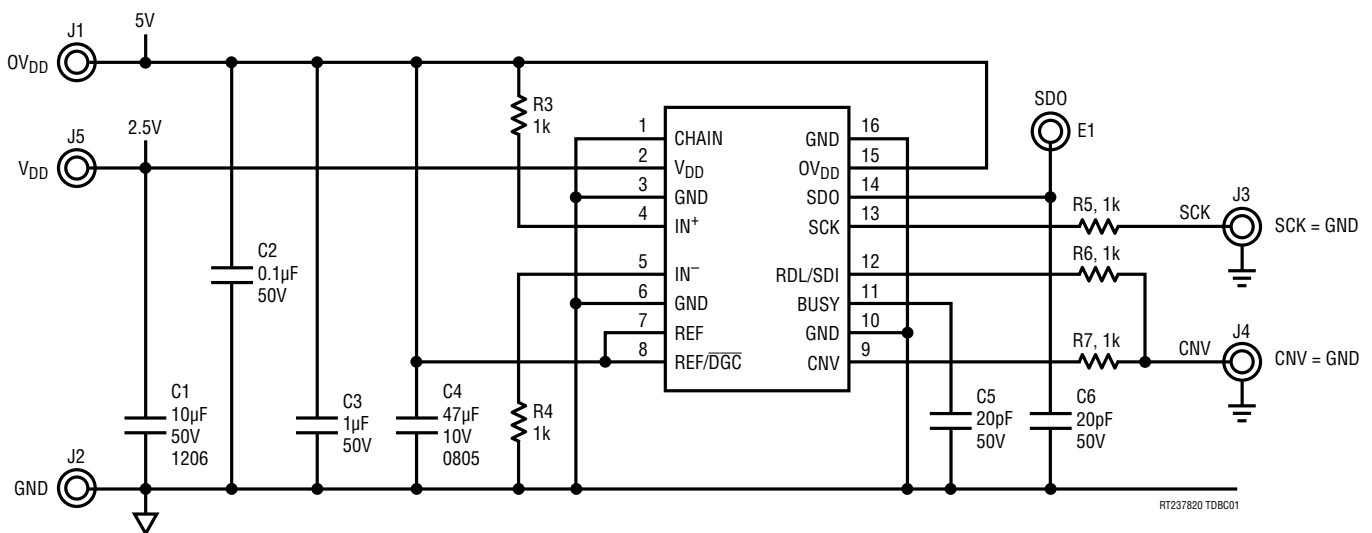

ELECTRICAL TEST REQUIREMENTS

MIL-STD-883 TEST REQUIREMENTS	SUBGROUP
Final Electrical Test Requirements (Method 5004)	1,* 2, 3, 4, 5, 6, 9, 10, 11
Group A Test Requirements (Method 5005)	1, 2, 3, 4, 5, 6, 9, 10, 11
Group B and D for Class S. End Point Electrical Parameters (Method 5005)	1, 2, 3

*PDA applies to subgroup 1. See PDA Test Notes.

PDA Test Notes

The PDA is specified as 5% based on failures from Group A, Subgroup 1, tests after cooldown as the final electrical test in accordance with method 5004 of MIL-STD-883. The verified failures of Group A, Subgroup 1, after burn-in divided by the total number of devices submitted for burn-in in that lot shall be used to determine the percent for the lot.

Linear Technology Corporation reserves the right to test to tighter limits than those given.

rt237820fa

ELECTRICAL CHARACTERISTICS: BURN-IN DELTA PARAMETERS

T_A = 25°C (Note 4)

SYMBOL	PARAMETER	CONDITION	MIN	TYP	TYP	UNITS
t _{CONV}	Conversion Time		-10		10	ns

BURN-IN CIRCUIT

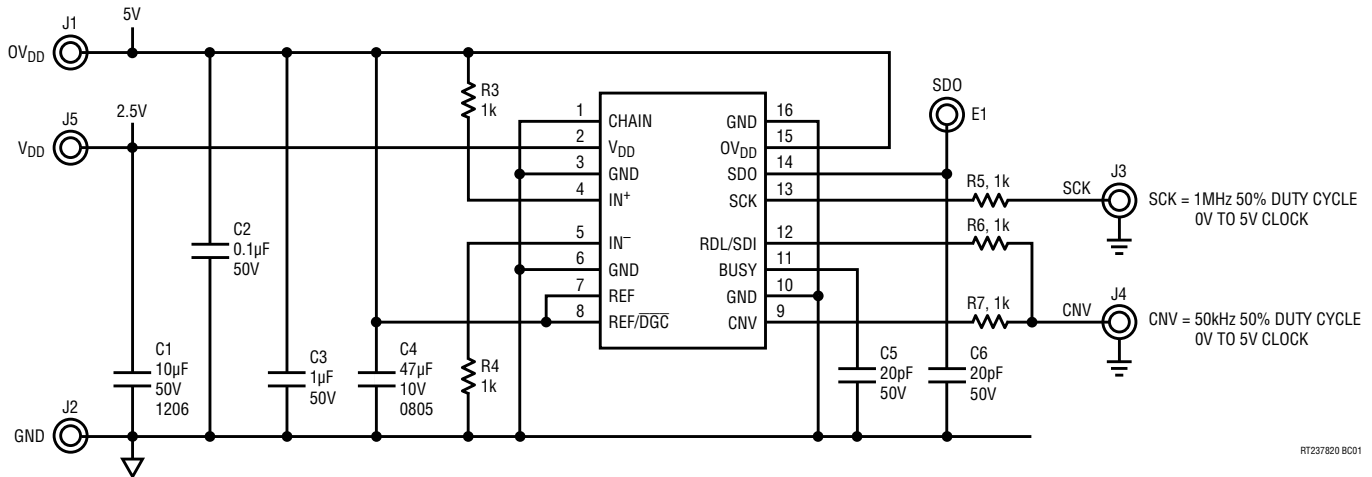

RT237820 BC01

Note 1: Stresses beyond those listed under Absolute Maximum Ratings may cause permanent damage to the device. Exposure to any Absolute Maximum Rating condition for extended periods may effect device reliability and lifetime.

Note 2: All voltage values are with respect to ground.

Note 3: When these pin voltages are taken below ground or above REF or OV_{DD}, they will be clamped by internal diodes. This product can handle input currents up to 100mA below ground or above REF or OV_{DD} without latch-up.

Note 4: V_{DD} = 2.5V, OV_{DD} = 2.5V, REF = 5V, V_{CM} = 2.5V, f_{SAMPL} = 1MHz, REF/DGC = V_{REF}.

Note 5: Recommended operating conditions.

Note 6: Integral nonlinearity is defined as the deviation of a code from a straight line passing through the actual endpoints of the transfer curve. The deviation is measured from the center of the quantization band.

Note 7: Bipolar zero-scale error is the offset voltage measured from -0.5LSB when the output code flickers between 0000 0000 0000 0000 and 1111 1111 1111 1111. Full-scale bipolar error is the worst-case of -FS or +FS untrimmed deviation from ideal first and last code transitions and includes the effect of offset error.

Note 8: All specifications in dB are referred to a full-scale ±5V input with a 5V reference voltage.

Note 9: f_{SAMPL} = 1MHz, I_{REF} varies proportionately with sample rate.

Note 10: Guaranteed by design, not subject to test.

Note 11: Parameter tested and guaranteed at OV_{DD} = 1.71V, OV_{DD} = 2.5V and OV_{DD} = 5.25V.

Note 12: t_{SCK} of 10ns maximum allows a shift clock frequency up to 100MHz for rising capture.

Note 13: Pre and post radiation limits are identical to those listed in specification tables, except as listed in the Converter Characteristics Post Radiation table. When performing post irradiation electrical measurements for any RHA level, T_A = 25°C.

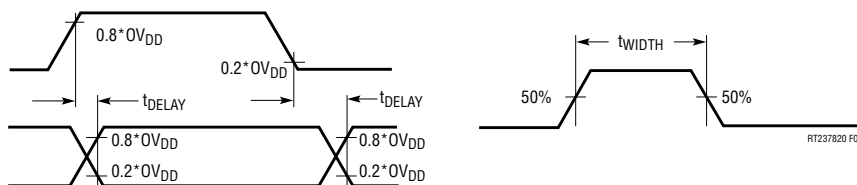
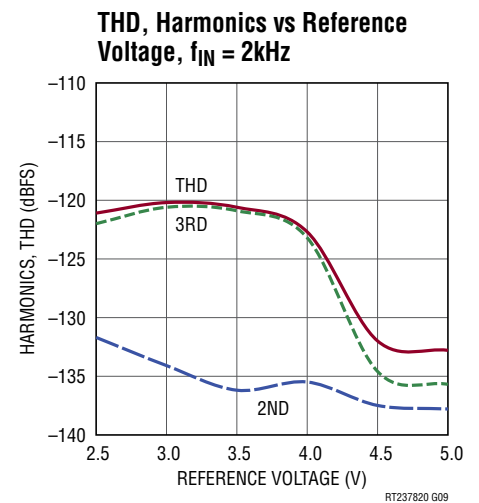
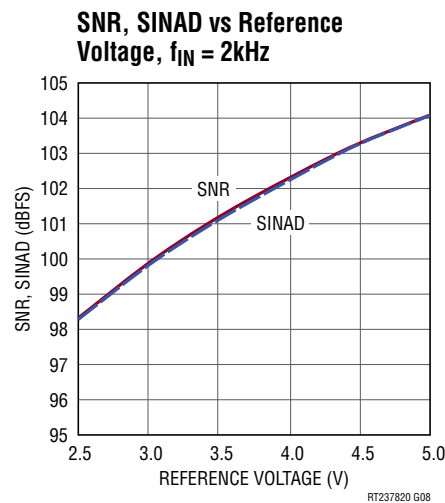
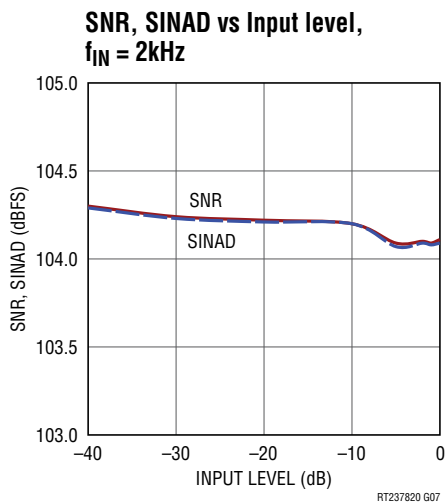
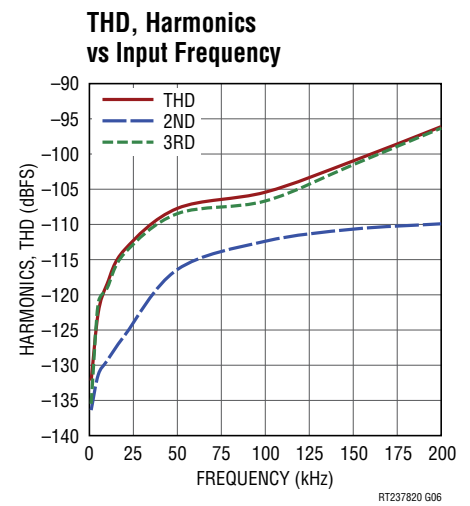
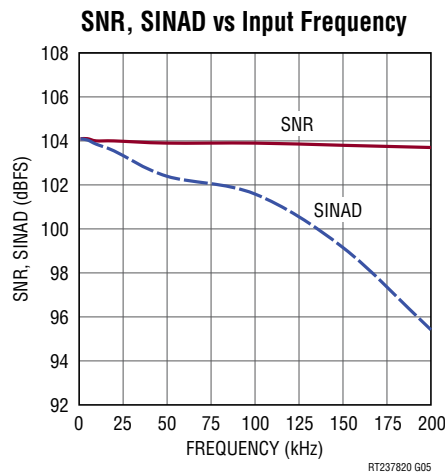
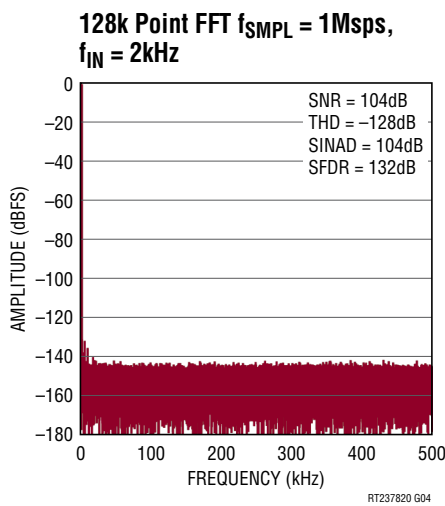
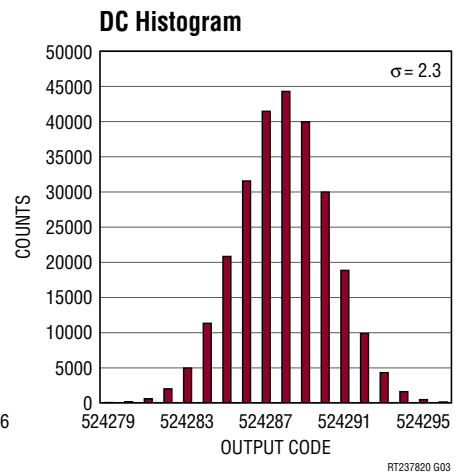
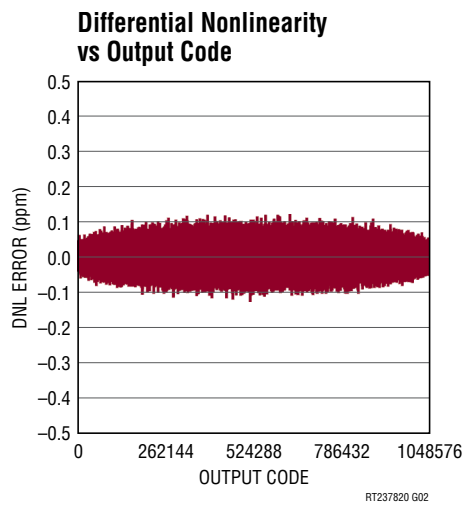
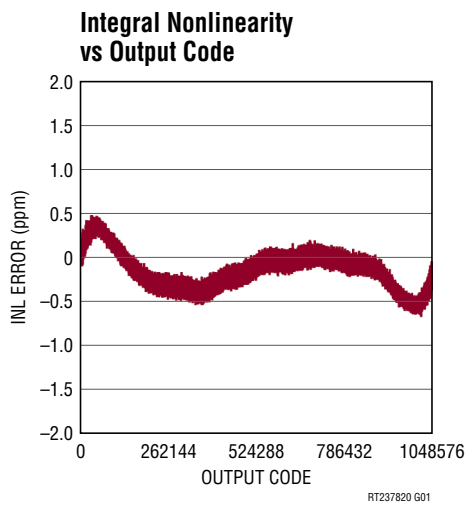

Figure 1. Voltage Levels for Timing Specifications

TYPICAL PERFORMANCE CHARACTERISTICS $T_A = 25^\circ\text{C}$, $V_{DD} = 2.5\text{V}$, $0V_{DD} = 2.5\text{V}$, $V_{CM} = 2.5\text{V}$,
 $REF = 5\text{V}$, $f_{SAMPL} = 1\text{Mps}$, unless otherwise noted.



RT2378-20

TYPICAL PERFORMANCE CHARACTERISTICS $T_A = 25^\circ\text{C}$, $V_{DD} = 2.5\text{V}$, $0V_{DD} = 2.5\text{V}$, $V_{CM} = 2.5\text{V}$, $REF = 5\text{V}$, $f_{SAMPL} = 1\text{Msps}$, unless otherwise noted.

SNR, SINAD vs Temperature,
 $f_{IN} = 2\text{kHz}$

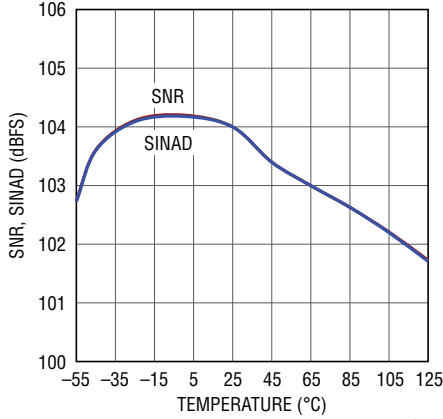

RT237820 G10

THD, Harmonics vs Temperature,
 $f_{IN} = 2\text{kHz}$

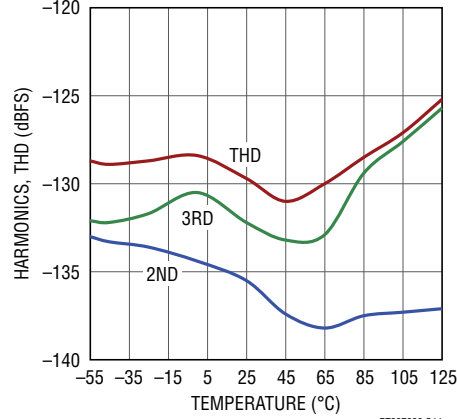

RT237820 G11

INL vs Temperature

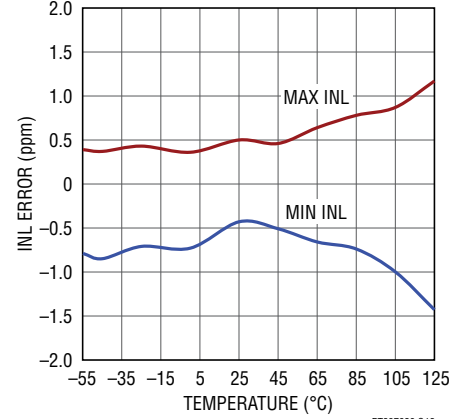

RT237820 G12

Full-Scale Error vs Temperature

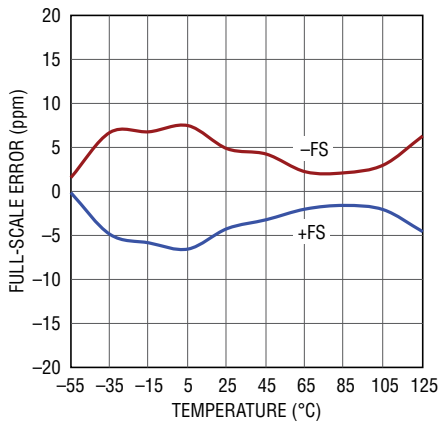

RT237820 G13

Offset Error vs Temperature

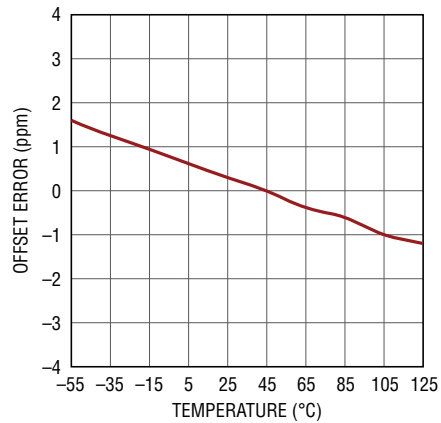

RT237820 G14

Supply Current vs Temperature

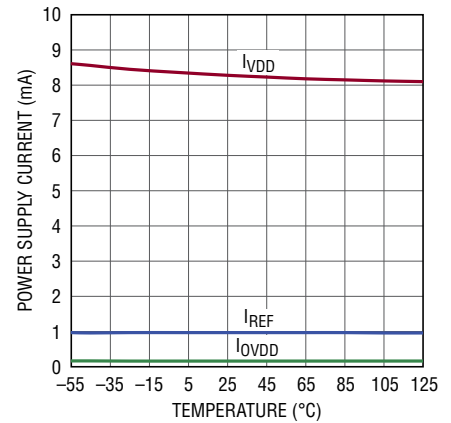

RT237820 G15

Shutdown Current vs Temperature

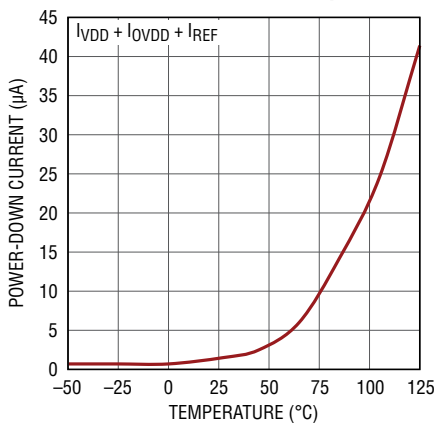

RT237820 G16

CMRR vs Input Frequency

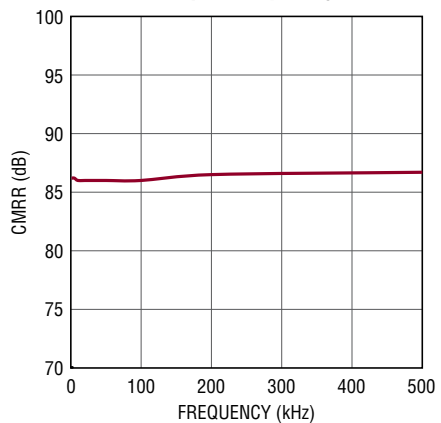

RT237820 G17

Reference Current vs Reference Voltage

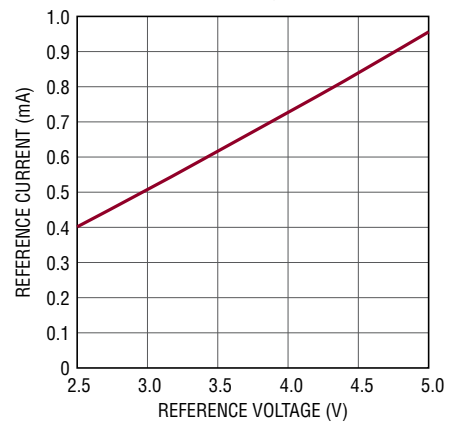

RT237820 G18

rt237820fa

REVISION HISTORY

REV	DATE	DESCRIPTION	PAGE NUMBER
A	11/16	Updated subgroup under Power Requirements	4

PACKAGE DESCRIPTION

Please refer to <http://www.linear.com/designtools/packaging/> for the most recent package drawings.

MS Package 16-Lead Plastic MSOP (Reference LTC DWG # 05-08-1669 Rev A)

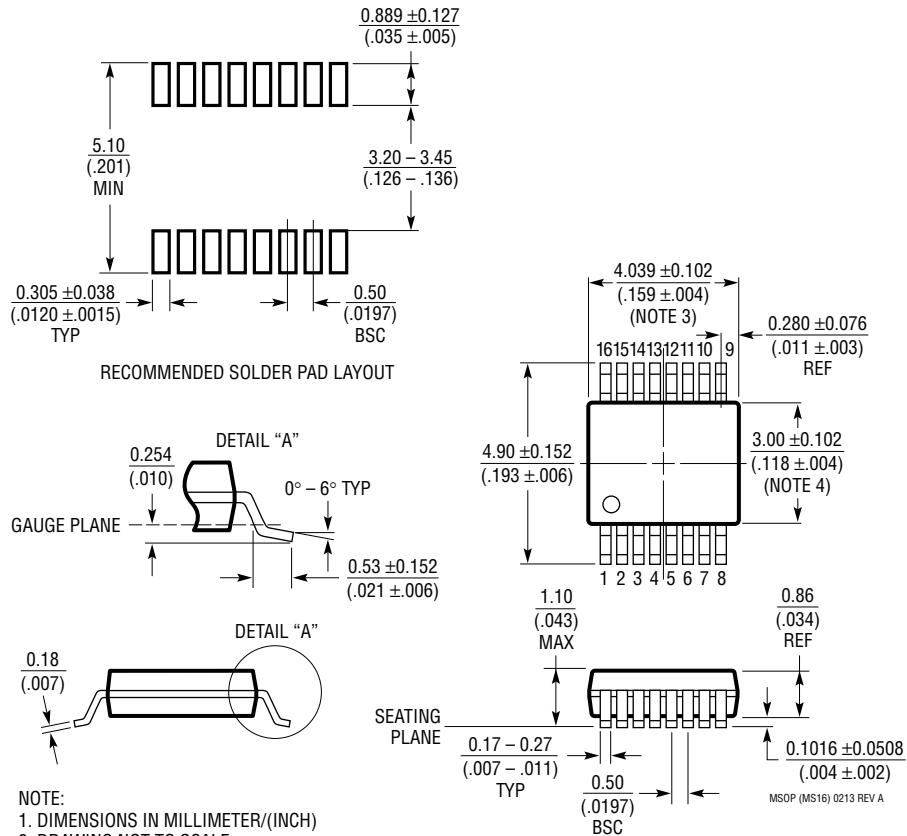

- NOTE:
1. DIMENSIONS IN MILLIMETER/(INCH)
 2. DRAWING NOT TO SCALE
 3. DIMENSION DOES NOT INCLUDE MOLD FLASH, PROTRUSIONS OR GATE BURRS.
MOLD FLASH, PROTRUSIONS OR GATE BURRS SHALL NOT EXCEED 0.152mm (.006") PER SIDE
 4. DIMENSION DOES NOT INCLUDE INTERLEAD FLASH OR PROTRUSIONS.
INTERLEAD FLASH OR PROTRUSIONS SHALL NOT EXCEED 0.152mm (.006") PER SIDE
 5. LEAD COPLANARITY (BOTTOM OF LEADS AFTER FORMING) SHALL BE 0.102mm (.004") MAX