

WF111 Data Sheet: 802.11 B/G/N Module

WF111 is a fully integrated single 2.4 GHz band 802.11 b/g/n module, intended for portable and battery powered applications, where Wi-Fi® connectivity is needed. WF111 integrates an IEEE 802.11 b/g/n radio, antenna or U.FL antenna connector and SDIO or CSPI host interfaces.

WF111 provides a low cost and simple Wi-Fi solution for devices that run an operating system and a TCP/IP stack on-board, but still offers the benefits of a module – small form factor, easy integration and certifications.

Target Applications:

- PoS terminals
- RFID and laser scanners
- Wi-Fi internet radios and audio streaming products
- Wireless cameras
- Portable navigation devices
- Portable handheld devices
- Wi-Fi medical sensors
- Wireless picture frames

KEY FEATURES

- IEEE 802.11 b/g/n radio
- Single stream 2.4 GHz band
- Bit rates up to 72.2 Mbps
- Integrated antenna or U.FL connector
- Hardware support for WEP, WPA and WPA2 encryption
- Soft-AP support
- Temperature range: -40 to +85 °C
- SDIO or CSPI host interfaces
- *Fully CE, FCC, IC, Japan and South-Korea certified*
- Operating system drivers for Linux

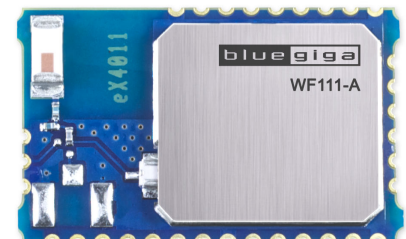

1. Ordering Information

WF111 Product Numbering

WF1 1 1- X

Antenna:
 A = Internal antenna
 E = External
 N = RF pin

Table 1.1. Confirmed Products and Codes

Product Code	Description
WF111-A-v1	WF111 module with internal chip antenna
WF111-E-v1	WF111 module with U.FL connector for external antenna
WF111-N-v1	WF111 module with 50 RF pin (Please contact Silicon Labs sales at www.silabs.com for availability)
DKWF111	WF111-A SDIO evaluation kit
WF111-A-v1-ETSI	ETSI version of WF111-A has 13 channels. This device is not FCC/IC compliant.
WF111-E-v1-ETSI	ETSI version of WF111-E has 13 channels. This device is not FCC/IC compliant .

Table of Contents

1. Ordering Information	2
2. Pinout and Terminal Descriptions	5
3. Interfaces	8
3.1 Host Interfaces	8
3.1.1 Host Selection	8
3.1.2 SDIO Interface	8
3.1.3 CSR Serial Peripheral Interface (CSPI)	9
3.1.4 SDIO/CSPI Deep-Sleep Control Schemes	10
3.2 Other Interfaces	10
3.2.1 Debug SPI Interface	10
3.2.2 I/O Pads	10
3.3 Power Control and Regulation	11
3.4 REGEN	12
3.5 RESET	12
4. Example Application Schematic	13
5. Wi-Fi Radio	15
5.1 Wi-Fi Receiver	15
5.2 Wi-Fi Transmitter	15
6. Electrical Characteristics	16
6.1 Absolute Maximum Ratings	16
6.2 Recommended Operating Conditions	16
6.3 Input/Output Terminal Characteristics	17
7. RF Characteristics	18
8. Power Consumption	20
9. Physical Dimensions	21
10. Layout Guidelines	22
10.1 WF111-A	22
10.2 WF111-E	22
10.3 WF111-N	23
10.4 Thermal Considerations	24
10.5 EMC Considerations	25
11. Soldering Recommendations	26
12. Product Packaging	27
13. Certifications	28
13.1 CE	28

13.2	FCC and IC	.28
13.2.1	FCC et IC	.29
13.3	MIC Japan	.31
13.4	KCC (South-Korea)	.31
13.5	Anatel (Brazil)	.31
13.6	Qualified Antenna Types for WF111-E	.31
14.	Revision History	32
14.1	Revision 1.5.0	.32
14.2	Revision 1.4.0	.32
14.3	Revision 1.3.0	.32
14.4	Revision 1.2.10	.32
14.5	Revision 1.2.9	.32
14.6	Revision 1.2.8	.32
14.7	Revision 1.2.7	.32
14.8	Revision 1.2.6	.32
14.9	Revision 1.2.5	.32
14.10	Revision 1.2.4	.32
14.11	Revision 1.2.3	.32
14.12	Revision 1.2.2	.32
14.13	Revision 1.2.1	.32
14.14	Revision 1.2.0	.33
14.15	Revision 1.1.9	.33
14.16	Revision 1.1.8	.33
14.17	Revision 1.1.7	.33
14.18	Revision 1.1.6	.33
14.19	Revision 1.1.5	.33
14.20	Revision 1.1.4	.33
14.21	Revision 1.1.3	.33
14.22	Revision 1.1.2	.33
14.23	Revision 1.1.1	.33
14.24	Revision 1.1	.33
14.25	Revision 1.0	.33

2. Pinout and Terminal Descriptions

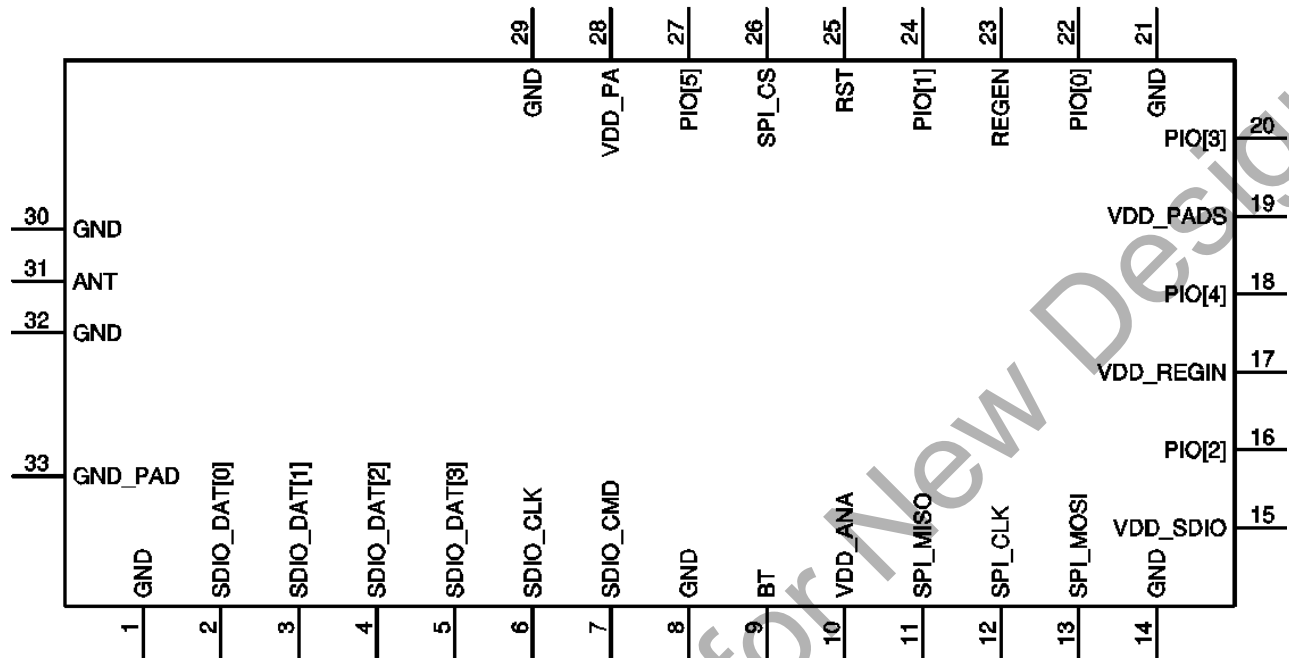

Figure 2.1. WF111 Pinout

Table 2.1. Supply Terminal Descriptions

Power Supplies	Pin Number	Description
VDD_REGIN	17	Input for the internal regulators
REGEN	23	Pull high to enable internal voltage regulators (2.0 V max)
GND	1, 8, 14, 21, 29, 30, 32	Ground
GND_PAD	33	Thermal pad, on bottom of WF111
VDD_ANA	10	Positive supply for PA control
VDD_PADS	19	Positive supply for the digital interfaces
VDD_SDIO	15	Positive supply for the SDIO interface
VDD_PA	28	Positive supply for the power amplifier

Table 2.2. GPIO Terminal Descriptions

PIO Port	Pin Number	Pad Type	Description
PIO[0]	22	Bi-directional, programmable strength internal pull-down/pull-up	Programmable input/output line
PIO[1]	24		
PIO[2]	16		
PIO[3]	20		
PIO[4]	18		
PIO[5]	27		

Table 2.3. Host Interface Terminal Descriptions

SDIO/CSPI Interfaces	Pin Number	Pad Type	Description
SDIO_DATA[0]	2	Bi-directional, tri-state, weak internal pull-up	Synchronous data input/output
SDIO_SPI_DI			SDIO SPI data output
CSPI_MISO			CSPI data output
SDIO_DATA[1]	3		Synchronous data input/output
SDIO_SPI_INT			SDIO SPI interrupt output
CSPI_INT			CSPI data input
SDIO_DATA[2]	4	Synchronous data input/output	
SDIO_DATA[3]	5	Bi-directional, weak/strong internal pull-up	Synchronous data input/output
SDIO_SPI_CS#			SDIO SPI chip select, active low
CSPI_CS#			CSPI chip select, active low
SDIO_CLK	6	Input, weak internal pull-up	SDIO clock
SDIO_SPI_SCLK			SDIO SPI clock
CSPI_CLK			CSPI clock
SDIO_CMD	7	Bi-directional, weak internal pull-up	SDIO data input
SDIO_SPI_MOSI			SDIO SPI data input
CSPI_MOSI			CSPI data input

Table 2.4. Other Terminal Descriptions

Other Signals	Pin Number	Pad Type	Description
RST	25	Input, weak internal pull-up, active low	System reset
ANT	31	RF, DC blocked	Antenna output on N variant, on A and E variants not connected
BT	9	RF, DC blocked	Bluetooth coexistence antenna sharing pin. Not supported by the firmware. Don't connect.

Table 2.5. Debug SPI Terminal Descriptions

Debug SPI Interface	Pin Number	Pad Type	Description
SPI_MISO	11	Output, tri-state, weak internal pull-down	Synchronous data output
SPI_CLK	12	Input, weak internal pull-down	Synchronous clock input
SPI_MOSI	13		Synchronous data input
SPI_CS	26		Chip select, active low

Not Recommended for New Designs

3. Interfaces

3.1 Host Interfaces

WF111 can be interfaced by the host using SDIO in 1bit or 4bit mode, SDIO SPI or CSR proprietary CSPI connection. The host connection buses can be clocked up to 50MHz. Due to the relatively high clock rate, the bus layout should be done carefully. To prevent radiated emissions and bus errors due to reflections, the host bus should be kept short, the signals should run over an uninterrupted ground plane and the clock line should be series terminated with a 22 to 33 ohm resistor as close to the clock output pin of the host processor as possible.

3.1.1 Host Selection

WF111 will default to 1-bit SDIO mode. The host interface can be set with 1-bit SDIO or SDIO SPI commands to the required mode. After mode selection, it will then remain in that mode until the module is reset either with the RESET pin or the internal power supply supervisor.

3.1.2 SDIO Interface

This is a host interface which allows a Secure Digital Input Output (SDIO) host to gain access to the internals of the chip. All defined slave modes (SPI, SD 1bit, SD 4bit) are provided.

Two functions are supported:

- Function 0 is mandatory function used for SDIO slave configuration. This contains CCCR, FBR and CIS. CCCR registers support sleep and wakeup signaling.
- Function 1 provides access to the IEEE 802.11 functionality. Command IO_RW_DIRECT (CMD52) is used to directly access internal registers. IO_RW_EXTENDED (CMD53) is used for block transfer to/from module MMU buffers.

Table 3.1. Supported Commands per Mode

Command	SD Mode (1/4 bit)	SDIO SPI Mode
GO_IDLE_STATE (CMD0)	Y	Y
SEND_RELATIVE_ADDR (CMD3)	Y	N
IO_SEND_OP_COND (CMD5)	Y	Y
SELECT/DESELECT_CARD (CMD7)	Y	N
GO_INACTIVE_STATE (CMD15)	Y	N
IO_RW_DIRECT (CMD52)	Y	Y
IO_RW_EXTENDED (CMD53)	Y	Y
CRC_ON_OFF (CMD59)	N	Y

For more information and detailed descriptions of above functions and commands, see the following specifications:

- SD Specifications Part 1 Physical Layer Specification v.1.10
- SD Specification Part E1 SDIO Specification v.1.10

3.1.3 CSR Serial Peripheral Interface (CSPI)

The CSPI is a host interface which shares pins with the SDIO. It contains a number of modifications on the SDIO SPI specification aimed at increasing the host bus efficiency in hosts supporting SPI but not SDIO. The main advantages compared to SDIO SPI are as follows:

- Burst transfer is continuous instead of blocks with CRC
- Timings are deterministic (fixed number of clocks) reducing the required interaction
- 16 bit registers are transferred as a single command instead of two 8 bit writes

MMU buffers are accessed using burst read/writes. The command and address fields are used to select the correct buffer. The CSPI is able to generate an interrupt to the host when a memory access fails. This interrupt line is shared with the SDIO functions.

The CSPI Interface is an extension of the basic SPI Interface, with the access type determined by the following fields:

- 8-bit command
- 24-bit address
- 16-bit burst length (optional). Only applicable for burst transfers into or out of the MMU

CSPI Read/Write Cycles

Register read/write cycles are used to access Function 0, Bluetooth acceleration and MCU registers.

Burst read/write cycles are used to access the MMU.

CSPI Register Write Cycle

The command and address are locked into the slave, followed by 16bits of write data. An Error Byte is returned on the MISO signal indicating whether or not the transfer has been successful.

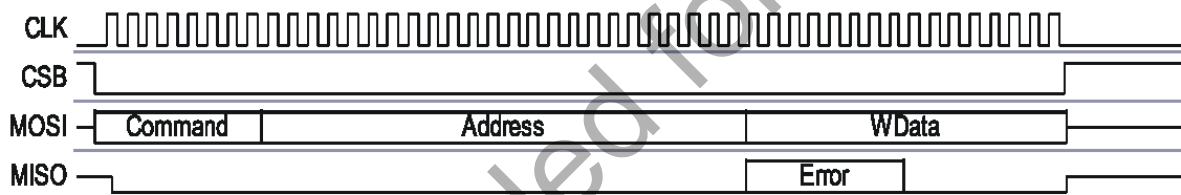

Figure 3.1. CSPI Register Write Cycle

CSPI Register Read Cycle

The command and address field are clocked into the slave, the slave then returns the following:

- Bytes of padding data (MISO held low)
- Error byte
- 16-bits of read data

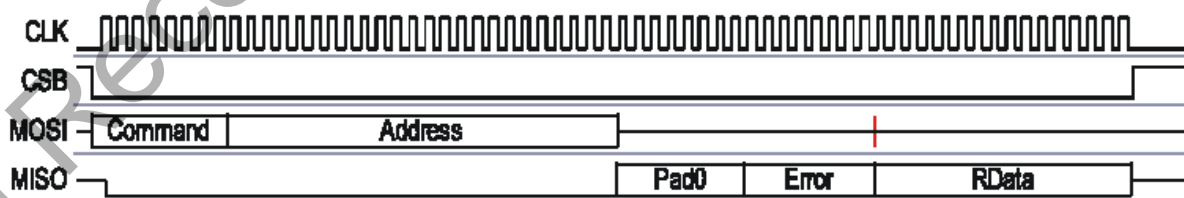

Figure 3.2. CSPI Register Read Cycle

CSPI Register Burst Write Cycle

Burst transfers are used to access the MMU buffers. They cannot be used to access registers. Burst read/write cycles are selected by setting the nRegister/Burst bit in the command field to 1.

Burst transfers are byte orientated, have a minimum length of 0 bytes and a maximum length of 64kbytes. Setting the length field to 0 results in no data being transferred to or from the MMU.

As with a register access, the command and address fields are transferred first. There is an optional length field transferred after the address. The use of the length field is controlled by the LengthFieldPresent bit in the Function 0 registers, which is cleared on reset.

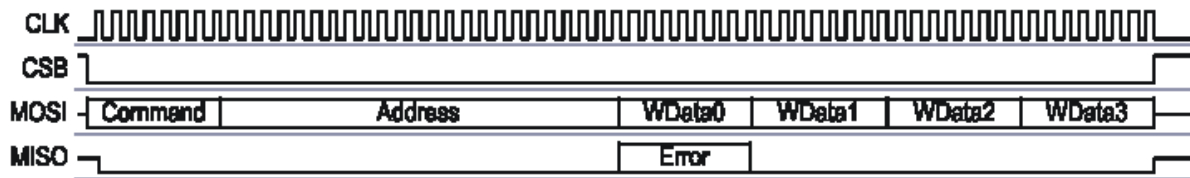

Figure 3.3. CSPI Burst Write Cycle

CSPI Register Read Cycle

Burst reads have a programmable amount of padding data that is returned by the slave. 0-15 bytes are returned as defined in the Burst-Padding register. Following this the Error byte is returned followed by the data. Once the transfer has started, no further padding is needed.

A FIFO within SDIO_TOP will pre-fetch the data. The address is not retransmitted, and is auto-updated within the slave.

The length field is transmitted if LengthFieldPresent in the Function 0 registers is set. In the absence of a length field the CSB signal is used to indicate the end of the burst.

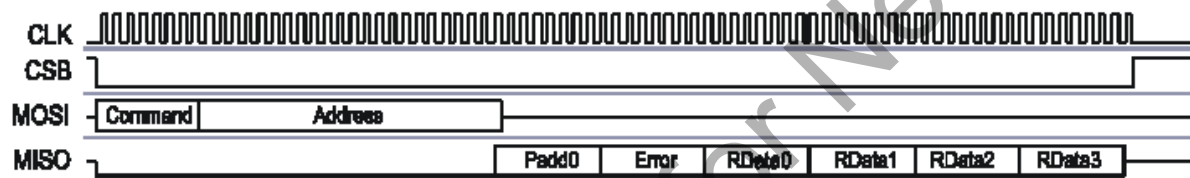

Figure 3.4. CSPI Burst Read Cycle

3.1.4 SDIO/CSPI Deep-Sleep Control Schemes

The module automatically enters deep sleep to minimize power consumption after a while of idling. Deep sleep is the lowest power mode, where the processor, the internal reference (fast) clock, and much of the digital and analogue hardware are shut down. The SDIO communication system however remains on, and is clocked by the host system. During deep sleep only the function 0 is available, while attempts to access Function 1 will likely result in bus timeouts. Function 0 is also available when the Wi-Fi core is physically powered off, as long as the VDD_SDIO supply is present.

Control of when the module is allowed to enter deep sleep is done via Vendor Unique Register in CCCR in function 0. Wake-up is also initiated through this register. The module will initiate an SDIO interrupt when the wake-up is complete.

3.2 Other Interfaces

3.2.1 Debug SPI Interface

A separate SPI bus is provided at the module pads for device access during testing and uploading settings during application development and manufacturing. This interface cannot be used as a host interface. It is recommended to bring these to a connector or test pads in case RF certification measurements that cannot be made through the host connection are required with the finished design. If it is not expected that certification measurements would be needed, the debug SPI pads should be left unconnected. The pads do not need external pull-ups when unconnected.

The debug SPI bus has logic levels set by the VDD_PADS reference supply line.

3.2.2 I/O Pads

A number of programmable bi-directional input/outputs (I/O) are present. Some of these are usable for driving a status LED. The PIO[0:5] logic levels are referred to the VDD_PADS supply line. All the PIO lines have internal pull-downs and should be left unconnected when not used.

3.3 Power Control and Regulation

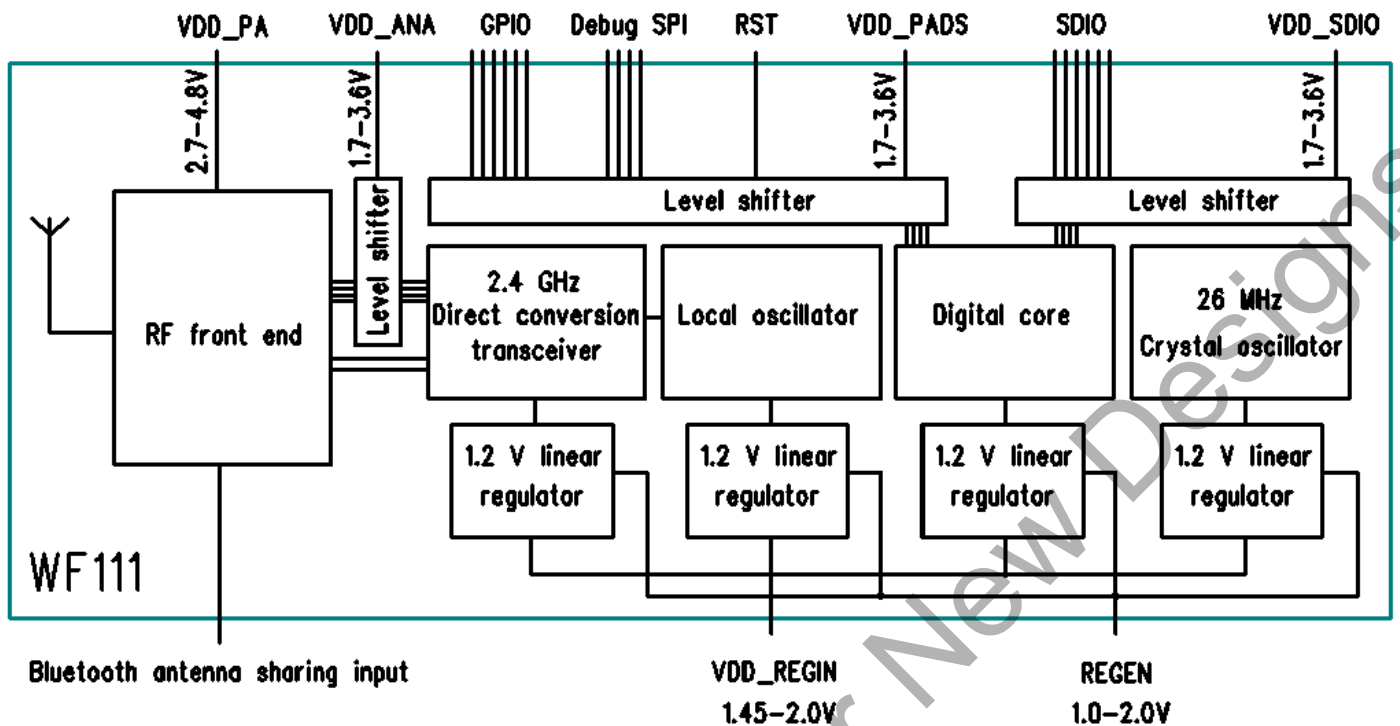

Figure 3.5. System Block Diagram

WF111 contains four linear regulators supplying clean voltages for the different parts of the system. All of them produce a 1.2 V output voltage, and are fed from a common input, VDD_REGIN. This input can be supplied with a voltage between 1.45-2.0 V, typically 1.5 V or 1.8 V. The VDD_REGIN supply should be relatively clean of ripple and switching spikes in order to avoid degrading the RF performance.

WF111 also needs four other supply lines connected in addition to VDD_REGIN:

- VDD_PADS provides a reference voltage for matching voltage levels of the host system to the GPIO pins and other functions. This can range from 1.7 V to 3.6 V. The current drawn from this supply is negligible.
- VDD_SDIO provides a reference voltage for matching voltage levels of the host system to the SDIO connection. This can range from 1.7V to 3.6V. The current drawn from this supply depends on bus usage, but with no active data transfer will be negligible.
- VDD_ANA provides a reference voltage for communication between the Wi-Fi chip and the power amplifier. This should be between 1.7 V and 3.6 V. The current drawn from this supply is negligible.
- VDD_PA is a separate supply voltage for the Wi-Fi power amplifier. This supply will draw considerable currents in pulses. The power traces should be relatively wide. This voltage can range from 2.7 V to 4.8 V making use directly from a single lithium cell possible. A higher supply voltage will not affect the power amplifiers current draw significantly. The regulator supplying VDD_PA should be capable of reacting to load changes within 5 μ s. Note: VDD_PA has an internal 2.2 μ F ceramic bypass capacitor, it should be made certain the regulator feeding VDD_PA is stable with ceramic load capacitors.

These voltages are not tied to each other and any combination of supply voltages within the specified limits can be used.

In a 3.3 V logic level host system all other supplies would usually be tied to the 3.3 V supply, with a separate regulator providing the 1.45-2.0 V supply for the Wi-Fi core. A switch mode regulator with 1.5 V output is recommended for minimum power consumption. Please see the example schematic in this datasheet.

In a 1.8 V logic level host system, all other supplies can be connected to the 1.8V supply rail except VDD_PA which should be connected to a 2.7-4.8 V supply.

The higher voltage supplies should be powered before or at the same time as the core supply line (i.e., **the VDD_REGIN should be powered up last**). Powering the core first may lead to the GPIO and SDIO blocks booting into an inaccessible state.

External high frequency bypassing for any the supply lines is not required, all supplies contain internal capacitors. If the VDD_PA line is fed directly from a battery or there are concerns about the speed of the regulator feeding it, a capacitor of around 100 μ F should be connected close to the module.

Note: All supply voltages and ground lines must be connected.

3.4 REGEN

The regulator enable pin REGEN is used to enable the WF111. REGEN enables the regulators of the digital and analog core supply voltages.

The pin is active high, with a logic threshold of around 1V, and has a weak pull-down. REGEN can tolerate voltages up to 2.0V, and may be connected directly to the internal voltage regulator input (VDD_REGIN) to permanently enable the device. Part of the regulators can also be disabled by firmware in power saving modes. The VDD_REGIN supply can also be externally switched off while leaving the other supply voltages powered.

Cutting power to the core will fully shut down the module internal processors and returning power will cause a power-on reset, requiring a full initialization of the module.

The REGEN pin will not disable system blocks not supplied by the core supply, so the SDIO Function 0 are available even when the core is powered off.

3.5 RESET

WF111 may be reset from several sources: RESET pin, power-on reset, via software configured watchdog timers as well as through the SDIO/CSPI host interface.

The RESET pin is an active low reset and is internally filtered using the internal low frequency clock oscillator. A reset is performed between 1.5 and 4.0ms following RESET being active. It is recommended that RESET be applied for a period greater than 5ms.

The power-on reset occurs when the core supply (generated by the internal 1.2V linear regulator) falls below typically 1.05V and is released when core voltage rises above typically 1.10V. At reset regardless of the source the digital I/O pins are set to a high impedance state with weak pull-downs, except RESET and DEBUG_SPI_CS# which have a weak pull-up. The host connection interface is only reset by the RESET pin or a power-on reset.

A power-on reset can be achieved through powering down the digital core by either externally cutting the VDD_REGIN supply or giving a low pulse to the REGEN-pad. If REGEN is connected to the host system for powering down the module, or a separate core power switch is implemented, the RESET pin can be tied permanently to a supply voltage line.

Following a reset, WF111 automatically generates internally the clocks needed for safe boot-up of the internal processors. The crystal oscillator is then configured by software with the correct input frequency.

Note: Holding the RESET line low will not drive the module into a low power consumption mode, it can't be used as a power-off signal.

4. Example Application Schematic

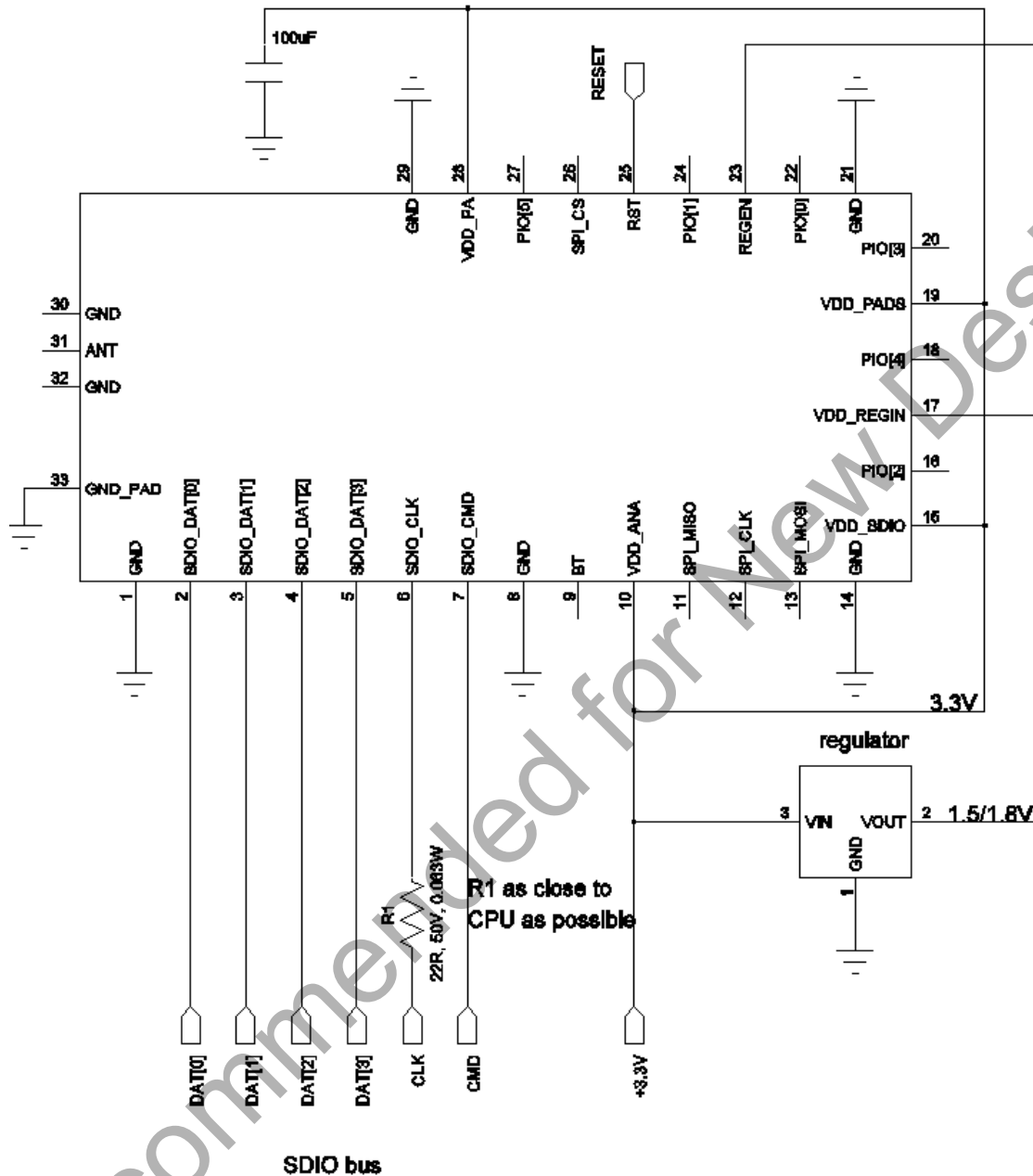

Figure 4.1. Example Application Circuit with SDIO Host Connection, 3.3 V Level Host Logic and 1.5/1.8 V Core Supply, REGEN Hard Wired to the Core Supply and RST Pad Used to Reset the Module

Note: With N-variant, ANT-pad and associated grounds would also be connected.

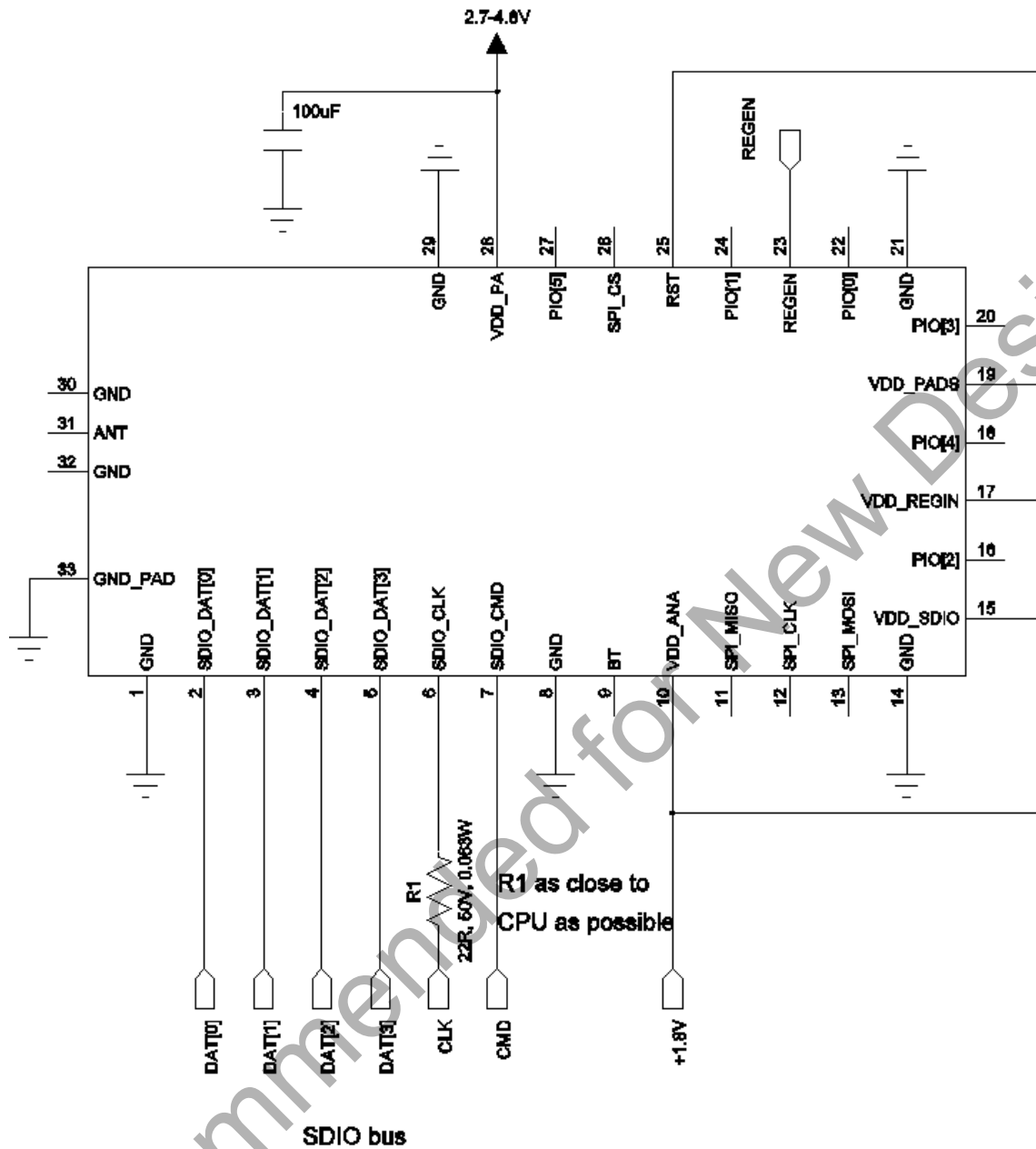

Figure 4.2. Example Application Circuit with SDIO Host Connection, 1.8 V Level Host Logic and a Separate Power Amplifier Supply, RST Hard Wired to the Core Supply and REGEN Pad Used to Power Off and Reset the Module

Note: With N-variant, ANT-pad and associated grounds would also be connected.

5. Wi-Fi Radio

5.1 Wi-Fi Receiver

The receiver features direct conversion architecture. Sufficient out-of-band blocking specification at the Low Noise Amplifier (LNA) input allows the receiver to be used in close proximity to Global System for Mobile Communications (GSM) and Wideband Code Division Multiple Access (W-CDMA) cellular phone transmitters without being desensitized. High-order baseband filters ensure good performance against in-band interference.

5.2 Wi-Fi Transmitter

The transmitter features a direct IQ modulator. Digital baseband transmit circuitry provides the required spectral shaping and on-chip trims are used to reduce IQ modulator distortion. Transmitter gain can be controlled on a per-packet basis, allowing the optimization of the transmit power as a function of modulation scheme.

The internal Power Amplifier (PA) has a maximum output power of +14dBm for IEEE 802.11g/n and +16dBm for IEEE 802.11b. The module internally compensates for PA gain and reference oscillator frequency drifts with varying temperature and supply voltage.

Not Recommended for New Designs

6. Electrical Characteristics

6.1 Absolute Maximum Ratings

Table 6.1. Absolute Maximum Ratings

Rating	Min	Max	Unit
Storage temperature	-40	85	°C
VDD_PADS, VDD_ANA, VDD_SDIO	-0.4	3.6	V
VDD_REGIN, REGEN	-0.4	2.5	V
VDD_PA	-0.4	6	V
Other terminal voltages	VSS+0.3	VDD+0.3	V

6.2 Recommended Operating Conditions

Table 6.2. Recommended Operating Conditions

Rating	Min	Max	Unit
Operating temperature range ¹	-40	85	°C
VDD_PADS, VDD_SDIO, VDD_ANA	1.7	3.6	V
VDD_PA	2.7	4.8	V
VDD_REGIN	1.45	2	V
Note:			
1. The module will heat up depending on use, at high transmit duty cycles the maximum operating temperature may need to be derated. See chapter 10.4 Thermal Considerations .			

6.3 Input/Output Terminal Characteristics

Table 6.3. Digital Terminal Electrical Characteristics

Digital Terminals	Min	Typ	Max	Unit
Input Voltage Levels				
V_{IL} input logic level low $1.7\text{ V} \leq V_{DD} \leq 3.6\text{ V}$	-0.3	—	$0.25 \cdot V_{DD}$	V
V_{IH} input logic level low $1.7\text{ V} \leq V_{DD} \leq 3.6\text{ V}$	$0.625 \cdot V_{DD}$	—	$V_{DD} + 0.3$	V
Output Voltage Levels				
V_{OL} output logic level low $1.7\text{ V} \leq V_{DD} \leq 3.6\text{ V}$, ($I_o = 4.0\text{ mA}$)	—	—	0.4	V
V_{OH} output logic level low $1.7\text{ V} \leq V_{DD} \leq 3.6\text{ V}$, ($I_o = -4.0\text{ mA}$)	$0.75 \cdot V_{DD}$	—	V_{DD}	V
Input Tri-state Current with the following:				
Strong pull-up	-150	-40	-10	μA
Strong pull-down	10	40	150	μA
Weak pull-up	-5	-1	-0.33	μA
Weak pull-down	0.33	1	5	μA
I/O pad leakage current	-1	0	1	μA
Pad input capacitance	1	—	5	pF

7. RF Characteristics

Table 7.1. Supported Frequencies

	Min	Max	Product Codes	Frequency		
				Min	Max	Unit
Channel	1	11	WF111-A-v1, WF111-E-v1, WF111-N-v1, DKWF111	2412	2462	MHz
Channel	1	13	WF111-A-v1-ETSI, WF111-E-v1-ETSI	2412	2472	MHz

Table 7.2. Supported Modulations

Standard	Supported Bit Rates
802.11b	1, 2, 5.5, 11 Mbps
802.11g	6, 9, 12, 18, 24, 36, 48, 54 Mbps
802.11n, HT, 20MHz, 800ns	6.5, 13, 19.5, 26, 39, 52, 58.5, 65 Mbps
802.11n, HT, 20MHz, 400ns	7.2, 14.4, 21.7, 28.9, 43.3, 57.8, 65, 72.2 Mbps

Table 7.3. Receiver Sensitivity

802.11b	Typ	802.11g	Typ	802.11n Short GI	Typ	802.11n Long GI	Typ
1 Mbps	-97 dBm	6 Mbps	-92 dBm	6.5 Mbps	-91 dBm	7.2 Mbps	-92 dBm
2 Mbps	-95 dBm	9 Mbps	-91 dBm	13 Mbps	-87 dBm	14.4 Mbps	-90 dBm
5.5 Mbps	-93 dBm	12 Mbps	-89 dBm	19.5 Mbps	-85 dBm	21.7 Mbps	-87 dBm
11 Mbps	-89 dBm	18 Mbps	-87 dBm	26 Mbps	-82 dBm	28.9 Mbps	-84 dBm
—	—	24 Mbps	-84 dBm	39 Mbps	-78 dBm	43.3 Mbps	-80 dBm
—	—	36 Mbps	-80 dBm	52 Mbps	-74 dBm	57.8 Mbps	-75 dBm
—	—	48 Mbps	-75 dBm	58.5 Mbps	-71 dBm	65 Mbps	-72 dBm
—	—	54 Mbps	-73 dBm	65 Mbps	-68 dBm	72.2 Mbps	-69 dBm

Table 7.4. Transmitter Output Power at Maximum Setting

Modulation Type	Measurement Type	Typical Value	Unit	Measurement According to
802.11b (1 Mbps)	RMS	+16	dBm	FCC/IC/ETSI
802.11b (1 Mbps)	Peak, max hold, 10 MHz RBW	+19.6	dBm	Anatel
802.11g (54 Mbps)	RMS	+14	dBm	FCC/IC/ETSI

Modulation Type	Measurement Type	Typical Value	Unit	Measurement According to
802.11g (54 Mbps)	20 MHz channel power, max hold, 1 MHz RBW	+20.6	dBm	Anatel
802.11n (72.2 Mbps)	RMS	+14	dBm	FCC/IC/ETSI
802.11n (72.2 Mbps)	20 MHz channel power, max hold, 1 MHz RBW	+21.1	dBm	Anatel

Table 7.5. BT Antenna Sharing Interface Properties

Operating Mode	Min	Typ	Max	Unit
Switch loss (TX and RX)	-2.5	-3	-3.5	dB

Table 7.6. Carrier Frequency Accuracy

Description	Typ	Max	802.11 Limit (Total Error)	Unit
Variation between individual units	±5	±10	±25	ppm
Variation with temperature	±5	±10	±25	ppm

8. Power Consumption

Table 8.1. Current Consumption During Specific Operating Modes

Operating Mode	VDD_PA/Peak	VDD_PA/Typ	VDD_REGIN/Peak	VDD_REGIN/Typ
Transmit (802.11b, 1M, +16 dBm)	248 mA	190 mA	240 mA	100 mA
Transmit (802.11b, 1M, +8 dBm)	—	144 mA	—	90 mA
Transmit (802.11g, 54M, +15 dBm)	—	154 mA	—	104 mA
Receive, no data	12 mA	10.5 mA	240 mA	114 mA
Deep sleep	—	9 μ A	—	75 μ A

Table 8.2. Average Current Consumption in Normal Use with Various Constant Throughputs Measured from Evaluation Board Test Point (Preliminary)

Operating Mode	Bit Rate	Throughput (sw. Limited)	Current/3.3 V
Transmit/802.11n	65 Mbps	12 Mbps	144 mA
Transmit/802.11g	18 Mbps	5.9 Mbps	192 mA
Transmit/802.11b	11 Mbps	4.8 Mbps	192 mA
Transmit/802.11b	1 Mbps	920 kbps	184 mA
Transmit/802.11n	72.2 Mbps	1 Mbps	74 mA*
Transmit/802.11g	54 Mbps	1 Mbps	78 mA
Transmit/802.11g	18 Mbps	1 Mbps	86 mA
Transmit/802.11b	11 Mbps	1 Mbps	94 mA
Transmit/802.11b	2 Mbps	1 Mbps	158 mA
Receive	72 Mbps	16.5 Mbps	88 mA
Receive	72 Mbps	1 Mbps	70 mA ¹
Idle, associated			1.7 mA ²
Idle, non-associated			110 μ A

Note:

1. The module draws about 70 mA in idle mode without power saves enabled.
2. With 100 ms beacon interval and full power save enabled. Increasing beacon interval will reduce consumption further.

9. Physical Dimensions

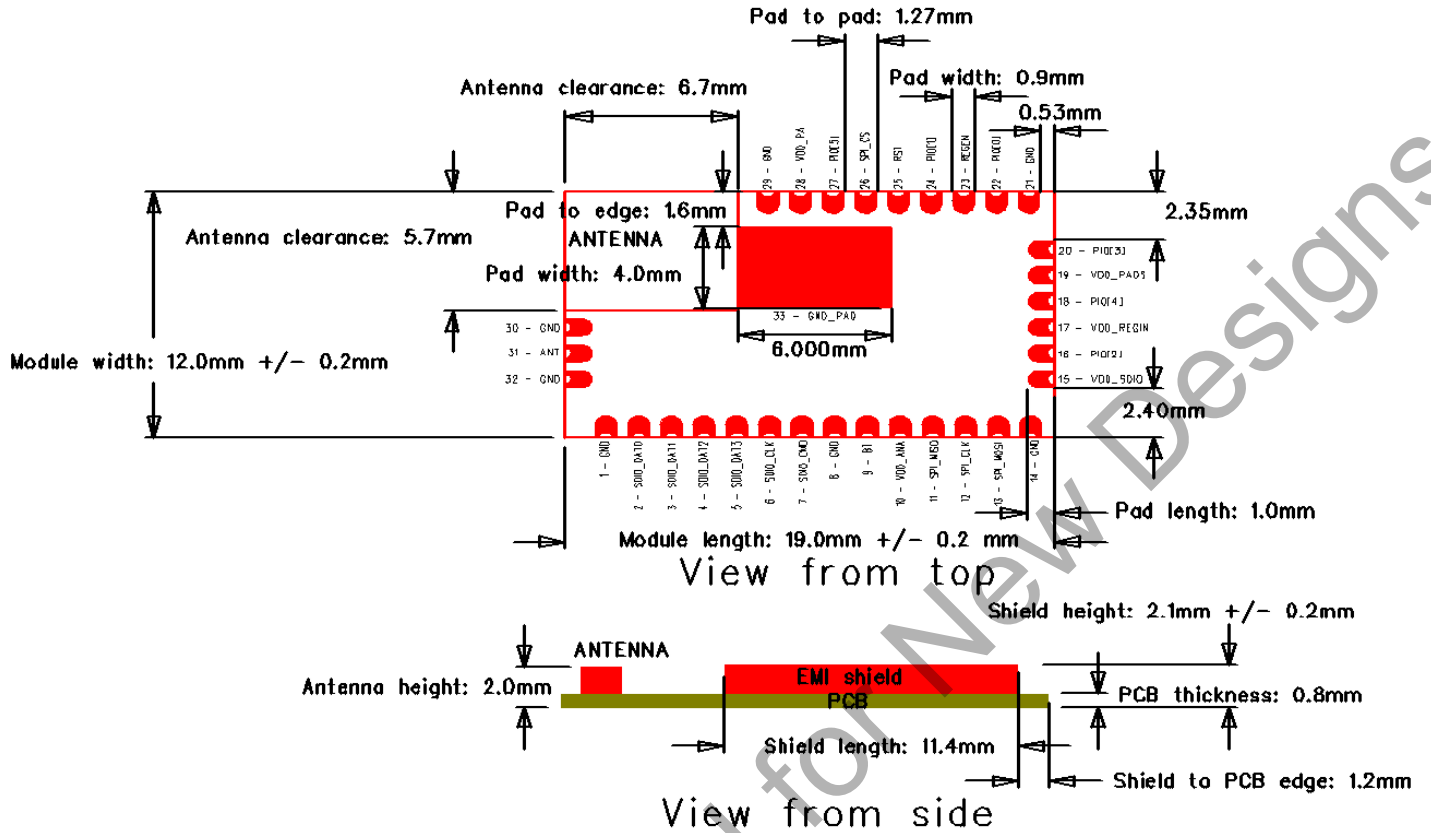

Figure 9.1. Physical Dimensions

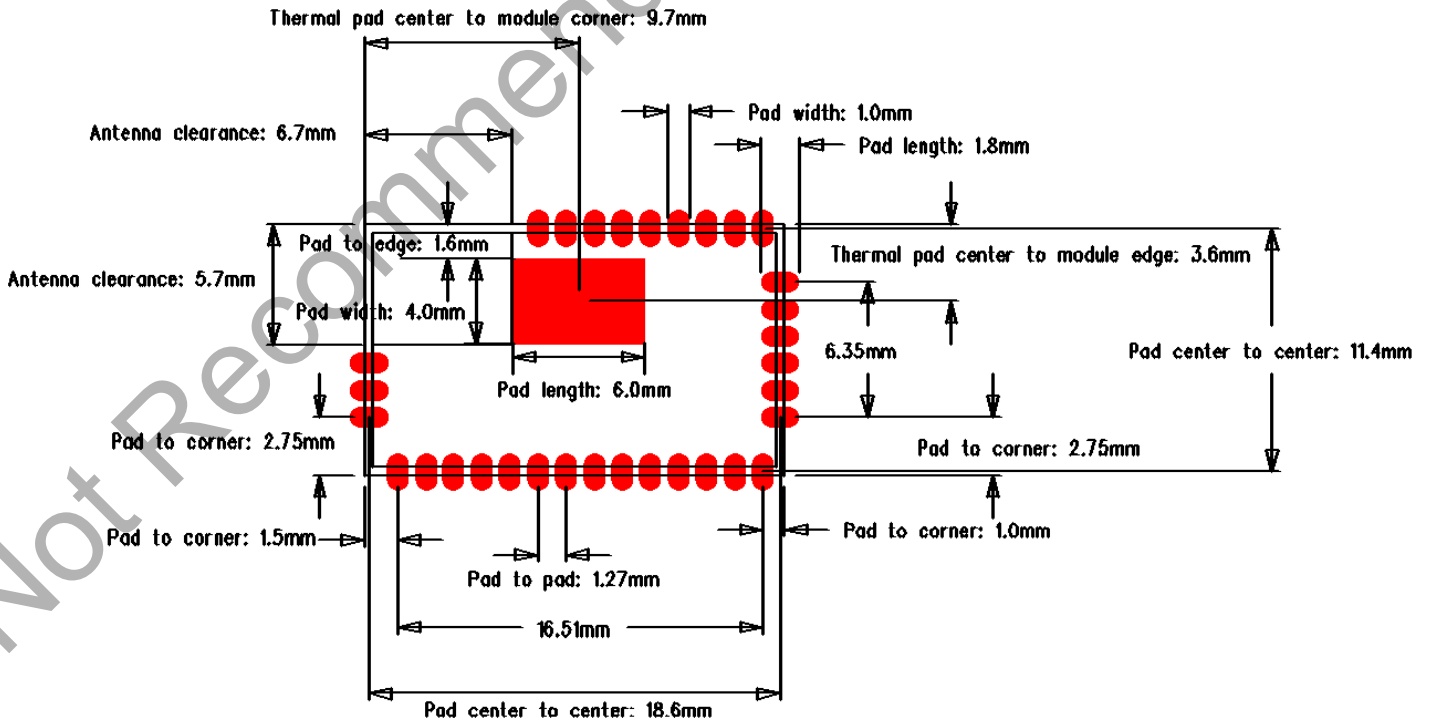

Figure 9.2. WF111 Recommended PCB Land Pattern

10. Layout Guidelines

10.1 WF111-A

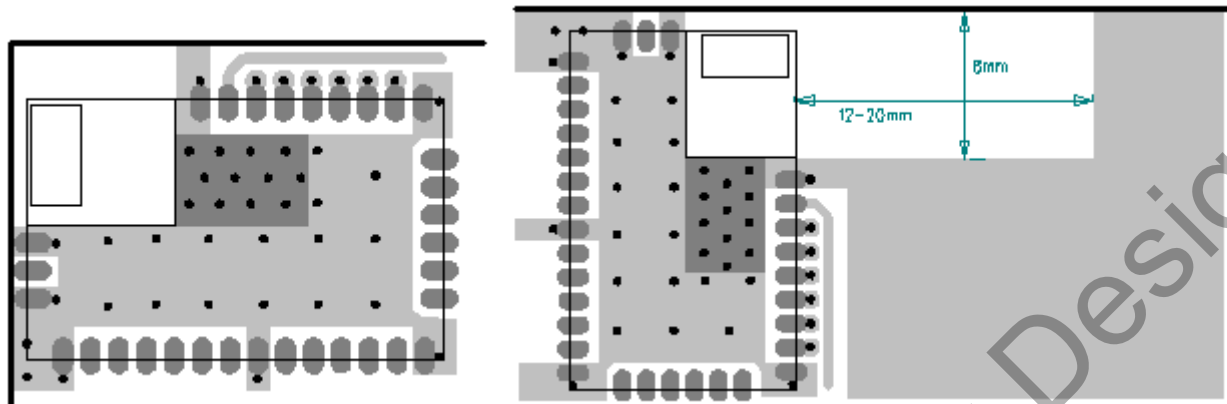

Figure 10.1. Recommended Layouts, On-Board Corner and On-Board Edge

See figure above for the suggested module layout. The impedance matching of the antenna is designed for a layout similar to the module evaluation board. For an optimal performance of the antenna the layout should strictly follow the layout example shown in [Figure 4.1 Example Application Circuit with SDIO Host Connection, 3.3 V Level Host Logic and 1.5/1.8 V Core Supply, REGEN Hard Wired to the Core Supply and RST Pad Used to Reset the Module on page 13](#) and the thickness of FR4 should be between 1 and 2 mm, preferably 1.6 mm.

Any dielectric material close to the antenna will change the resonant frequency and it is recommended not to place a plastic case or any other dielectric closer than 5 mm from the antenna.

ANY metal in close proximity of the antenna will prevent the antenna from radiating freely. It is recommended not to place any metal or other conductive objects closer than 20 mm to the antenna except in the directions of the ground planes of the module itself.

For optimal performance, place the antenna end of the module outside any metal surfaces and objects in the application, preferably on the device corner. The larger the angle in which no metallic object obstructs the antenna radiation, the better the antenna will work.

DO NOT place WF111-A in the middle of the application board. Even with a board cutout around the antenna the range will be bad.

The three pads on the antenna end of the WF111-A can be connected to the ground or left unsoldered.

10.2 WF111-E

RF output can be taken directly from the U.FL connector of the module, and no antenna clearances need to be made for the module. The three pads on the antenna end of the module can be connected to the ground or left unsoldered.

10.3 WF111-N

Antenna connection is routed to pad 31. Pads 30 and 32 beside the antenna connection should be properly connected to the ground plane. No antenna clearances are needed for the module itself. The antenna trace should be properly impedance controlled and kept short. The figure below shows a typical 50 ohm trace from the RF pin to a SMA connector.

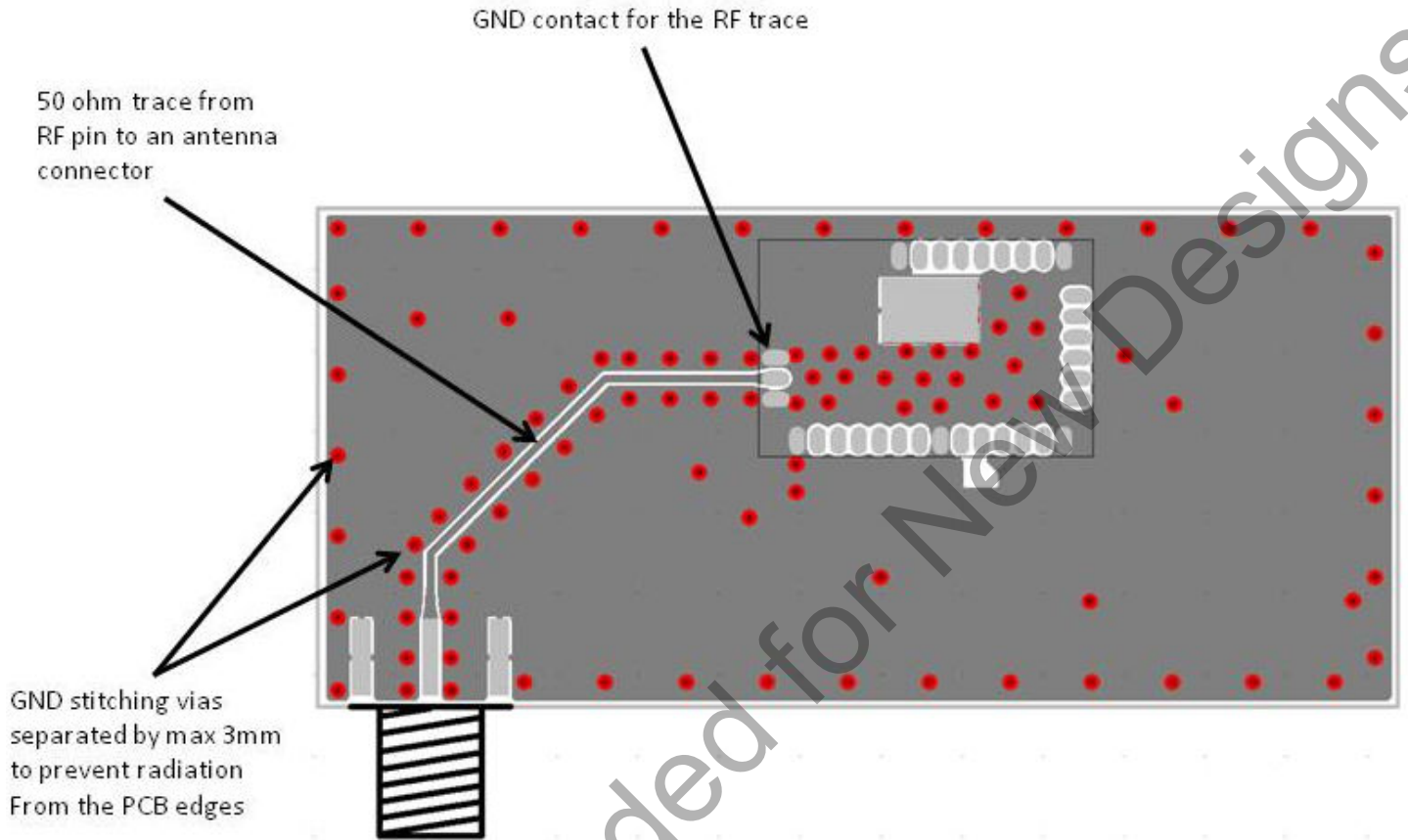

Figure 10.2. Typical 50 Trace for WF111-N

A transmission line impedance calculator, such as TX-Line made by AWR, can be used to approximate the dimensions for the 50 ohm transmission line. The figure below shows an example for two different 50 ohm transmission lines.

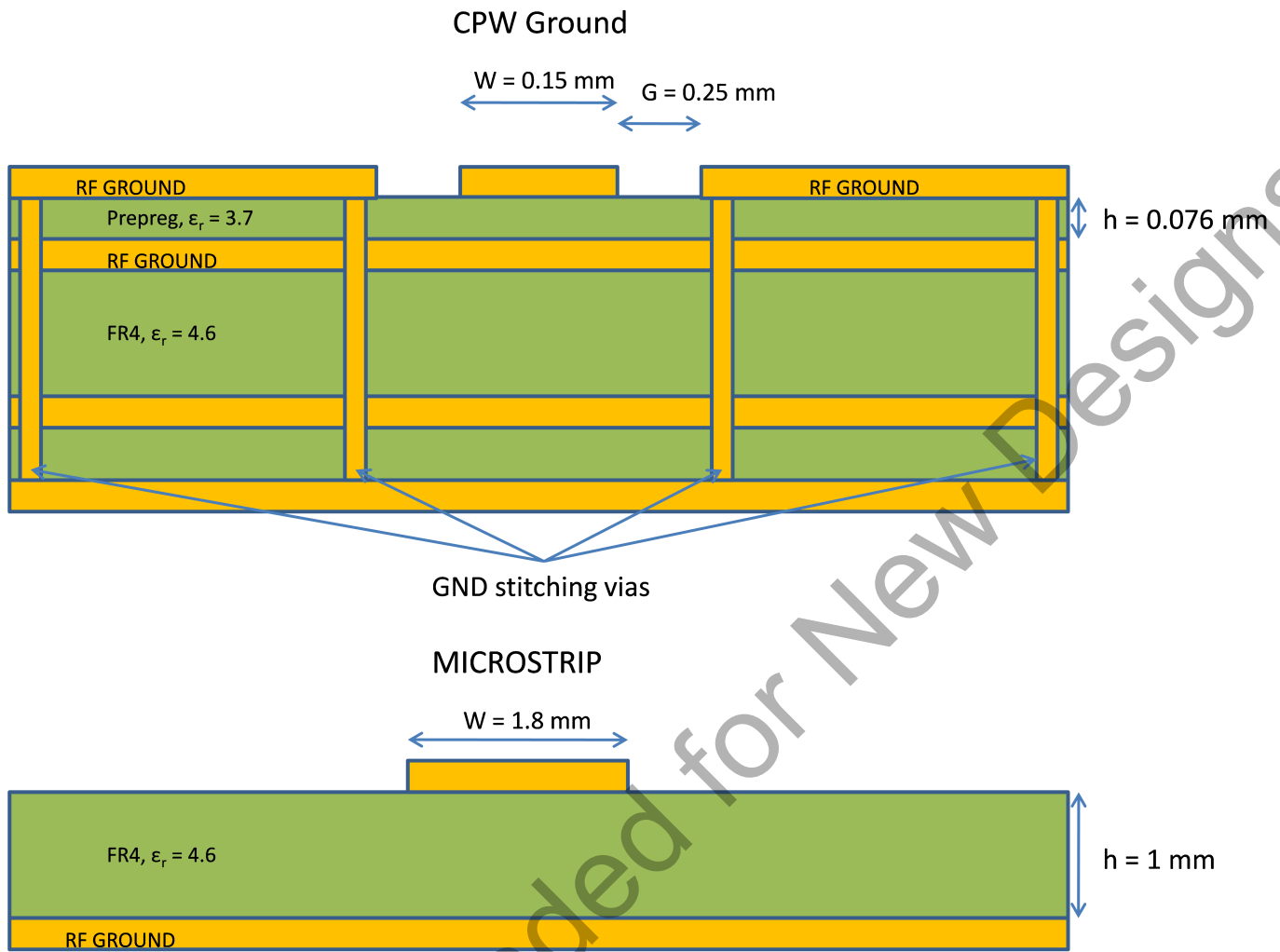

Figure 10.3. Example Cross Section of Two Different 50 ohm Transmission Line

10.4 Thermal Considerations

The WF111 module may at continuous full power transmit consume up to 1 W of DC power, most of which is drawn by the power amplifier. Most of this will be dissipated as heat. In any application where high ambient temperatures and constant transmissions for more than a few seconds can occur, it is important that a sufficient cooling surface is provided to dissipate the heat.

The thermal pad in the bottom of the module must be connected to the application board ground planes by soldering. The application board should provide a number of vias under and around the pad to conduct the produced heat to the board ground planes, and preferably to a copper surface on the other side of the board in order to dissipate the heat into air.

The module internal thermal resistance should in most cases be negligible compared to the thermal resistance from the module into air, and common equations for surface area required for cooling can be used to estimate the temperature rise of the module. Only copper planes on the circuit board surfaces with a solid thermal connection to the module ground pad will dissipate heat. For an application with high transmit duty cycles (low bit rate, high throughput, long bursts or constant streaming) the maximum allowed ambient temperature should be reduced due to inherent heating of the module, especially with small fully plastic enclosed applications where heat transfer to ambient air is low due to low thermal conductivity of plastic.

The module measured on the evaluation board exhibits a temperature rise of about 25°C above ambient temperature when continuously transmitting IEEE 802.11b at full power with minimal off-times and no collision detection (a worst case scenario regarding power dissipation). An insufficiently cooled module will rapidly heat beyond operating range in ambient room temperature.

10.5 EMC Considerations

Following recommendations helps to avoid EMC problems arising in the design. Note that each design is unique and the following list do not consider all basic design rules such as avoiding capacitive coupling between signal lines. The following list is aimed to avoid EMC problems caused by RF part of the module.

- Do not remove copper from the PCB more than needed. For proper operation the antenna requires a solid ground plane with as much surface area as possible. Use ground filling as much as possible. Connect all grounds together with multiple vias. Do not leave small floating unconnected copper areas or areas connected by just one via, these will act as additional antennas and raise the risk of unwanted radiations.
- Do not place a ground plane underneath the antenna. The grounding areas under the module should be designed as shown in [Figure 10.1 Recommended Layouts, On-Board Corner and On-Board Edge on page 22](#).
- When using overlapping ground areas use conductive vias separated max. 3 mm apart at the edge of the ground areas. This prevents RF from penetrating inside the PCB. Use ground vias extensively all over the PCB. All the traces in (and on) the PCB are potential antennas. Especially board edges should have grounds connected together at short intervals (stitching) to avoid resonances.
- Avoid current loops. Keep the traces with sensitive, high current or fast signals short, and mind the return current path, having a short signal path is not much use if the associated ground path between the ends of the signal trace is long. Remember, ground is also a signal trace. The ground will conduct the same current as the signal path and at the same frequency, power and sensitivity.
- Split a ground plane ONLY if you know exactly what you are doing. Splitting the plane may cause more harm than good if applied incorrectly. The ground plane acts as a part of the antenna system. Insufficient ground planes or large separate sensitive signal ground planes will easily cause the coupled transmitted pulses to be AM-demodulated by semiconductor junctions around the board, degrading system performance.

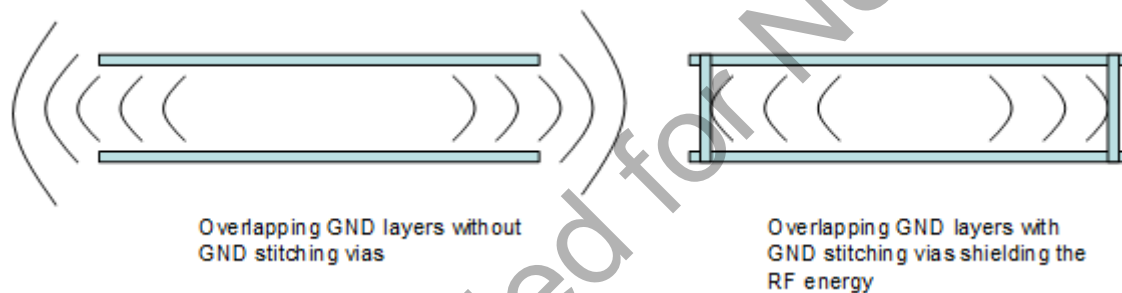

Figure 10.4. Use of Stitching Vias to Avoid Emissions from the Edges of the PCB

11. Soldering Recommendations

WF111 is compatible with industrial standard reflow profile for Pb-free solders. The reflow profile used is dependent on the thermal mass of the entire populated PCB, heat transfer efficiency of the oven and particular type of solder paste used. Consult the datasheet of particular solder paste for profile configurations.

Silicon Labs will give following recommendations for soldering the module to ensure reliable solder joint and operation of the module after soldering. Since the profile used is process and layout dependent, the optimum profile should be studied case by case. Thus following recommendation should be taken as a starting point guide.

- Refer to technical documentations of particular solder paste for reflow profile configurations
- Avoid using more than one flow.
- Reliability of the solder joint and self-alignment of the component are dependent on the solder volume. Minimum of 150µm stencil thickness is recommended.
- Aperture size of the stencil should be 1:1 with the pad size.
- A low residue, “no clean” solder paste should be used due to low mounted height of the component.

If the vias used on the application board have a diameter larger than 0.3 mm, it is recommended to mask the via holes at the module side to prevent solder wicking through the via holes. Solders have a habit of filling holes and leaving voids in the thermal pad solder junction, as well as forming solder balls on the other side of the application board which can in some cases be problematic.

Not Recommended for New Designs

12. Product Packaging

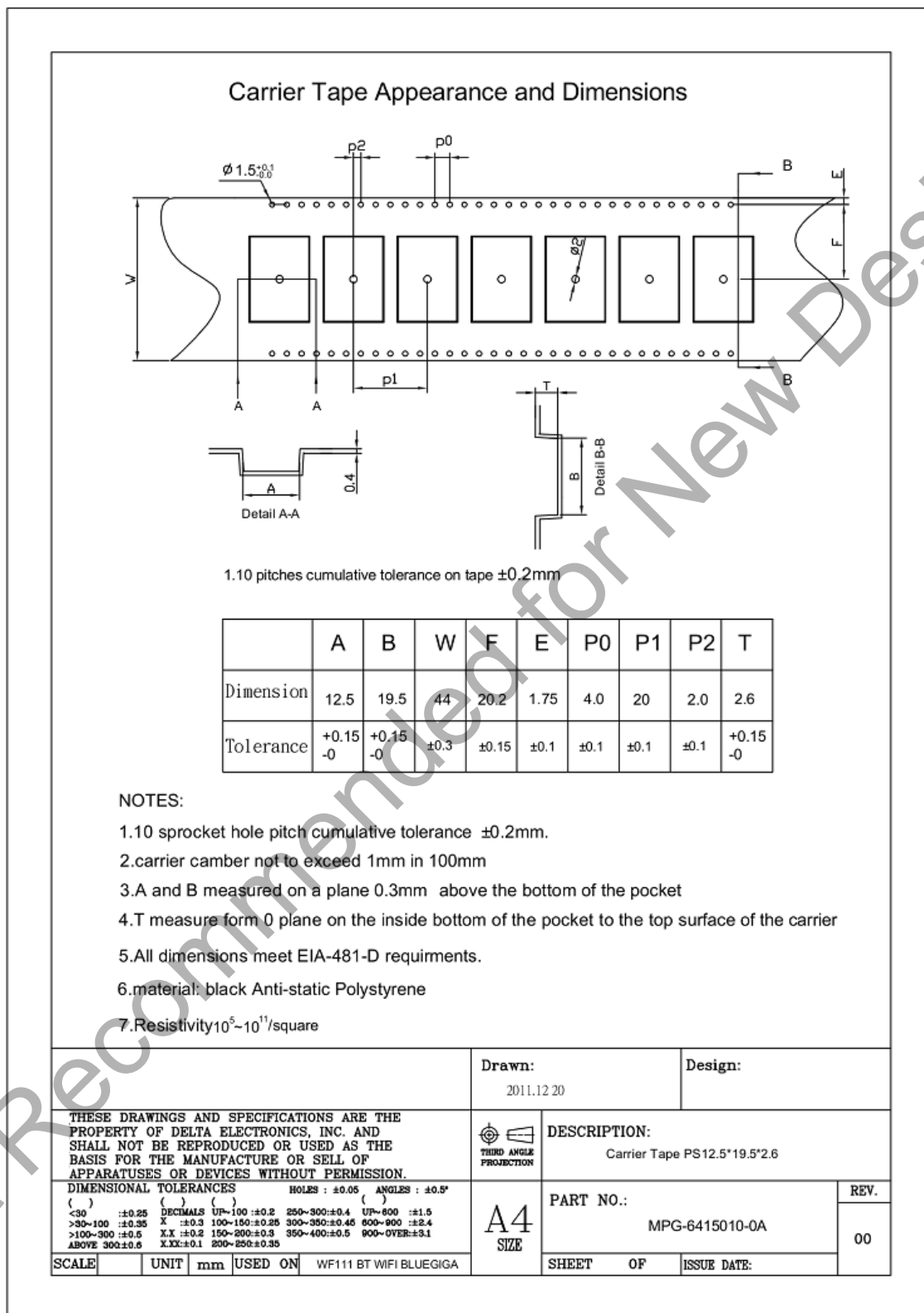

13. Certifications

WF111 is compliant to the following specifications:

13.1 CE

WF111 is in conformity with the essential requirements and other relevant requirements of the R&TTE Directive (1999/5/EC). The product is conformity with the following standards and/or normative documents.

EMC (immunity only): EN 301 489

Radiated emissions: EN 300 328

Safety standards: EN 60950

13.2 FCC and IC

This device complies with Part 15 of the FCC Rules. Operation is subject to the following two conditions:

- (1) this device may not cause harmful interference,
- (2) this device must accept any interference received, including interference that may cause undesired operation, and
- (3) the Product codes with WF111-A-v1-ETSI and WF-E-v1-ETSI are not FCC/IC compliant and must not be used in areas, where FCC/IC compliance is needed.

FCC RF Radiation Exposure Statement:

This equipment complies with FCC radiation exposure limits set forth for an uncontrolled environment. End users must follow the specific operating instructions for satisfying RF exposure compliance. This transmitter must not be co-located or operating in conjunction with any other antenna or transmitter. This transmitter is considered as mobile device and should not be used closer than 20 cm from a human body. To allow portable use in a known host class 2 permissive change is required. Please contact the support at www.silabs.com for detailed information.

IC Statements:

This device complies with Industry Canada license-exempt RSS standard(s). Operation is subject to the following two conditions: (1) this device may not cause interference, and (2) this device must accept any interference, including interference that may cause undesired operation of the device.

Under Industry Canada regulations, this radio transmitter may only operate using an antenna of a type and maximum (or lesser) gain approved for the transmitter by Industry Canada. To reduce potential radio interference to other users, the antenna type and its gain should be so chosen that the equivalent isotropically radiated power (e.i.r.p.) is not more than that necessary for successful communication.

If Detachable Antennas are Used:

This radio transmitter (identify the device by certification number, or model number if Category II) has been approved by Industry Canada to operate with the antenna types listed below with the maximum permissible gain and required antenna impedance for each antenna type indicated. Antenna types not included in this list, having a gain greater than the maximum gain indicated for that type, are strictly prohibited for use with this device. See table 22 for the approved antennas for WF111-E and WF111-N.

OEM Responsibilities to Comply with FCC and Industry Canada Regulations

The WF111 Module has been certified for integration into products only by OEM integrators under the following conditions:

The antenna(s) must be installed such that a minimum separation distance of 20cm is maintained between the radiator (antenna) and all persons at all times.

The transmitter module must not be co-located or operating in conjunction with any other antenna or transmitter.

As long as the two conditions above are met, further transmitter testing will not be required. However, the OEM integrator is still responsible for testing their end-product for any additional compliance requirements required with this module installed (for example, digital device emissions, PC peripheral requirements, etc.).

IMPORTANT NOTE: In the event that these conditions cannot be met (for certain configurations or co-location with another transmitter), then the FCC and Industry Canada authorizations are no longer considered valid and the FCC ID and IC Certification Number cannot be used on the final product. In these circumstances, the OEM integrator will be responsible for re-evaluating the end product (including the transmitter) and obtaining a separate FCC and Industry Canada authorization.

End Product Labeling

The WF111 Module is labeled with its own FCC ID and IC Certification Number. If the FCC ID and IC Certification Number are not visible when the module is installed inside another device, then the outside of the device into which the module is installed must also display a label referring to the enclosed module. In that case, the final end product must be labeled in a visible area with the following:

“Contains Transmitter Module FCC ID: QQQWF111”

“Contains Transmitter Module IC: 5123A-BGTWF111”

or

“Contains FCC ID: QQQWF111

“Contains IC: 5123A-BGTWF111”

The OEM of the WF111 Module must only use the approved antenna(s) described in table 22, which have been certified with this module.

The OEM integrator has to be aware not to provide information to the end user regarding how to install or remove this RF module or change RF related parameters in the user manual of the end product.

To comply with FCC and Industry Canada RF radiation exposure limits for general population, the antenna(s) used for this transmitter must be installed such that a minimum separation distance of 20cm is maintained between the radiator (antenna) and all persons at all times and must not be co-located or operating in conjunction with any other antenna or transmitter.

13.2.1 FCC et IC

Cet appareil est conforme à l’alinéa 15 des règles de la FCC. Deux conditions sont à respecter lors de son utilisation :

cet appareil ne doit pas créer d’interférence susceptible de causer un quelconque dommage et,

cet appareil doit accepter toute interférence, quelle qu’elle soit, y compris les interférences susceptibles d’entraîner un fonctionnement non requis.

Déclaration de conformité FCC d’exposition aux radiofréquences (RF):

Ce matériel respecte les limites d’exposition aux radiofréquences fixées par la FCC dans un environnement non contrôlé. Les utilisateurs finaux doivent se conformer aux instructions d’utilisation spécifiées afin de satisfaire aux normes d’exposition en matière de radiofréquence. Ce transmetteur ne doit pas être installé ni utilisé en concomitance avec une autre antenne ou un autre transmetteur. Ce transmetteur est assimilé à un appareil mobile et ne doit pas être utilisé à moins de 20 cm du corps humain. Afin de permettre un usage mobile dans le cadre d’un matériel de catégorie 2, il est nécessaire de procéder à quelques adaptations. Pour des informations détaillées, veuillez contacter le support technique, www.silabs.com.

Déclaration de conformité IC :

Ce matériel respecte les standards RSS exempt de licence d'Industrie Canada. Son utilisation est soumise aux deux conditions suivantes :

l'appareil ne doit causer aucune interférence, et

l'appareil doit accepter toute interférence, quelle qu'elle soit, y compris les interférences susceptibles d'entraîner un fonctionnement non requis de l'appareil.

Selon la réglementation d'Industrie Canada, ce radio-transmetteur ne peut utiliser qu'un seul type d'antenne et ne doit pas dépasser la limite de gain autorisée par Industrie Canada pour les transmetteurs. Afin de réduire les interférences potentielles avec d'autres utilisateurs, le type d'antenne et son gain devront être définis de telle façon que la puissance isotrope rayonnante équivalente (EIRP) soit juste suffisante pour permettre une bonne communication.

Lors de l'utilisation d'antennes amovibles :

Ce radio-transmetteur (identifié par un numéro certifié ou un numéro de modèle dans le cas de la catégorie II) a été approuvé par Industrie Canada pour fonctionner avec les antennes référencées ci-dessous dans la limite de gain acceptable et l'impédance requise pour chaque type d'antenne cité. Les antennes non référencées possédant un gain supérieur au gain maximum autorisé pour le type d'antenne auquel elles appartiennent sont strictement interdites d'utilisation avec ce matériel. Veuillez vous référer au tableau 22 concernant les antennes approuvées pour les WF111.

Les responsabilités de l'intégrateur afin de satisfaire aux réglementations de la FCC et d'Industrie Canada :

Les modules WF111 ont été certifiés pour entrer dans la fabrication de produits exclusivement réalisés par des intégrateurs dans les conditions suivantes :

L'antenne (ou les antennes) doit être installée de façon à maintenir à tout instant une distance minimum de 20cm entre la source de radiation (l'antenne) et toute personne physique.

Le module transmetteur ne doit pas être installé ou utilisé en concomitance avec une autre antenne ou un autre transmetteur.

Tant que ces deux conditions sont réunies, il n'est pas nécessaire de procéder à des tests supplémentaires sur le transmetteur. Cependant, l'intégrateur est responsable des tests effectués sur le produit final afin de se mettre en conformité avec d'éventuelles exigences complémentaires lorsque le module est installé (exemple : émissions provenant d'appareils numériques, exigences vis-à-vis de périphériques informatiques, etc.) ;

IMPORTANT : Dans le cas où ces conditions ne peuvent être satisfaites (pour certaines configurations ou installation avec un autre transmetteur), les autorisations fournies par la FCC et Industrie Canada ne sont plus valables et les numéros d'identification de la FCC et de certification d'Industrie Canada ne peuvent servir pour le produit final. Dans ces circonstances, il incombera à l'intégrateur de faire réévaluer le produit final (comprenant le transmetteur) et d'obtenir une autorisation séparée de la part de la FCC et d'Industrie Canada.

Étiquetage du produit final

Chaque module WF111 possède sa propre identification FCC et son propre numéro de certification IC. Si l'identification FCC et le numéro de certification IC ne sont pas visibles lorsqu'un module est installé à l'intérieur d'un autre appareil, alors l'appareil en question devra lui aussi présenter une étiquette faisant référence au module inclus. Dans ce cas, le produit final doit comporter une étiquette placée de façon visible affichant les mentions suivantes :

« Contient un module transmetteur certifié FCC QQQWF111 »

« Contient un module transmetteur certifié IC 5123A-BGTWF111 »

ou

« Inclut la certification FCC QQQWF111 »

« Inclut la certification IC 5123A-BGTWF111 »

L'intégrateur du module WF111 ne doit utiliser que les antennes répertoriées dans le tableau 25 certifiées pour ce module.

L'intégrateur est tenu de ne fournir aucune information à l'utilisateur final autorisant ce dernier à installer ou retirer le module RF, ou bien changer les paramètres RF du module, dans le manuel d'utilisation du produit final.

Afin de se conformer aux limites de radiation imposées par la FCC et Industrie Canada, l'antenne (ou les antennes) utilisée pour ce transmetteur doit être installée de telle sorte à maintenir une distance minimum de 20cm à tout instant entre la source de radiation (l'antenne) et les personnes physiques. En outre, cette antenne ne devra en aucun cas être installée ou utilisée en concomitance avec une autre antenne ou un autre transmetteur.

13.3 MIC Japan

WF111 has type approval for Japan with certification ID R 209- J00061

13.4 KCC (South-Korea)

WF111 has modular certification for Korean market with certification ID KCC-CRM-BGT-WF111

13.5 Anatel (Brazil)

WF111 has type approval in Brazil with identification number 01234-16-03402.

13.6 Qualified Antenna Types for WF111-E

This device has been designed to operate with the antennas listed below, and having a maximum gain of 2.14 dBi. Antennas not included in this list or having a gain greater than 2.14 dBi are strictly prohibited for use with this device. The required antenna impedance is 50 ohms.

Table 13.1. Qualified Antenna Types for WF111-E

Qualified Antenna Types for WF111-E	
Antenna Type	Maximum Gain
Dipole	2.14 dBi
Inverted F-antenna	2.2 dBi

Any antenna that is of the same type and of equal or less directional gain as listed in table above can be used without a need for retesting. To reduce potential radio interference to other users, the antenna type and its gain should be so chosen that the equivalent isotropically radiated power (e.i.r.p.) is not more than that permitted for successful communication. Using an antenna of a different type or gain more than 2.14 dBi will require additional testing for FCC, CE and IC. Please, contact the technical support at www.silabs.com for more information.

14. Revision History

14.1 Revision 1.5.0

July 18, 2019

- Added ETSI version OPNs to support 13. The OPNs are not FCC/IC compliant.

14.2 Revision 1.4.0

August 3, 2017

- Anatel certification number added. Custom OPN support for 13 channels removed.

14.3 Revision 1.3.0

- Removed references to coexistence, CE standard version numbers, replaced contact information, updated Bluegiga references to Silicon Labs.

14.4 Revision 1.2.10

- Anatel measurements.

14.5 Revision 1.2.9

- .11gn power specification fixed.

14.6 Revision 1.2.8

- TX power table updated.

14.7 Revision 1.2.7

- Contact and antenna information updated.

14.8 Revision 1.2.6

- Part numbers updated.

14.9 Revision 1.2.5

- Added notes on host bus layout.

14.10 Revision 1.2.4

- EN 300 328 V1.7.1 -> V1.8.1.

14.11 Revision 1.2.3

- Improved footprint drawing.

14.12 Revision 1.2.2

- MIC Japan and KCC certification info.

14.13 Revision 1.2.1

- Repaired broken ToC.

14.14 Revision 1.2.0

- Removed unnecessary register information, changes to coexistence description, removed references to engineering sample versions.

14.15 Revision 1.1.9

- Added tape & reel info.

14.16 Revision 1.1.8

- Listed supported coexistence schemes.

14.17 Revision 1.1.7

- Different coexistence pad bindings, replaced MIB keys with MIB file names.

14.18 Revision 1.1.6

- Added CE information, corrected supported channels for default FCC version.

14.19 Revision 1.1.5

- Some new consumption measurements.

14.20 Revision 1.1.4

- WT111-N layout guide.

14.21 Revision 1.1.3

- FCC and IC information added.

14.22 Revision 1.1.2

- Added frequency variation table.

14.23 Revision 1.1.1

- Added sleep clock specifications.

14.24 Revision 1.1

- Product codes updated.

14.25 Revision 1.0

- Initial release.

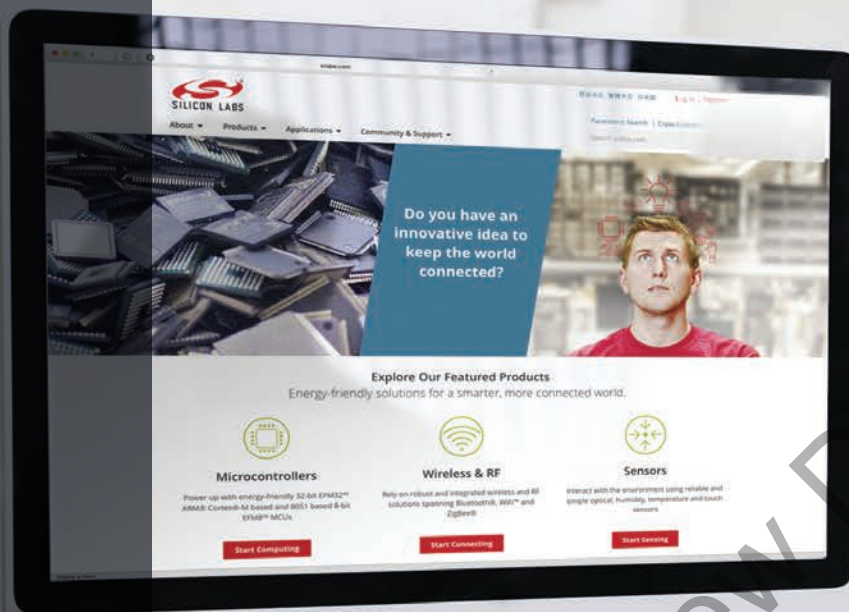

Smart.
Connected.
Energy-Friendly.



Products
www.silabs.com/products



Quality
www.silabs.com/quality



Support and Community
community.silabs.com

Disclaimer

Silicon Labs intends to provide customers with the latest, accurate, and in-depth documentation of all peripherals and modules available for system and software implementers using or intending to use the Silicon Labs products. Characterization data, available modules and peripherals, memory sizes and memory addresses refer to each specific device, and "Typical" parameters provided can and do vary in different applications. Application examples described herein are for illustrative purposes only. Silicon Labs reserves the right to make changes without further notice to the product information, specifications, and descriptions herein, and does not give warranties as to the accuracy or completeness of the included information. Without prior notification, Silicon Labs may update product firmware during the manufacturing process for security or reliability reasons. Such changes will not alter the specifications or the performance of the product. Silicon Labs shall have no liability for the consequences of use of the information supplied in this document. This document does not imply or expressly grant any license to design or fabricate any integrated circuits. The products are not designed or authorized to be used within any FDA Class III devices, applications for which FDA premarket approval is required or Life Support Systems without the specific written consent of Silicon Labs. A "Life Support System" is any product or system intended to support or sustain life and/or health, which, if it fails, can be reasonably expected to result in significant personal injury or death. Silicon Labs products are not designed or authorized for military applications. Silicon Labs products shall under no circumstances be used in weapons of mass destruction including (but not limited to) nuclear, biological or chemical weapons, or missiles capable of delivering such weapons. Silicon Labs disclaims all express and implied warranties and shall not be responsible or liable for any injuries or damages related to use of a Silicon Labs product in such unauthorized applications.

Trademark Information

Silicon Laboratories Inc.®, Silicon Laboratories®, Silicon Labs®, SiLabs® and the Silicon Labs logo®, Bluegiga®, Bluegiga Logo®, ClockBuilder®, CMEMS®, DSPLL®, EFM®, EFM32®, EFR®, Ember®, Energy Micro, Energy Micro logo and combinations thereof, "the world's most energy friendly microcontrollers", Ember®, EZLink®, EZRadio®, EZRadioPRO®, Gecko®, Gecko OS, Gecko OS Studio, ISOModem®, Precision32®, ProSLIC®, Simplicity Studio®, SiPHY®, Telegesis, the Telegesis Logo®, USBXpress®, Zentri, the Zentri logo and Zentri DMS, Z-Wave®, and others are trademarks or registered trademarks of Silicon Labs. ARM, CORTEX, Cortex-M3 and THUMB are trademarks or registered trademarks of ARM Holdings. Keil is a registered trademark of ARM Limited. Wi-Fi is a registered trademark of the Wi-Fi Alliance. All other products or brand names mentioned herein are trademarks of their respective holders.



Silicon Laboratories Inc.
400 West Cesar Chavez
Austin, TX 78701
USA

<http://www.silabs.com>