



Humidity Sensor

CHS series

Humidity Sensor

Product compatible with RoHS directive

Overview of the CHS series

APPLICATION

Refrigerators (condensation prevention),
 Air conditioners (indoor humidity control),
 PPCs, LBPs (image quality control),
 Industrial electronic humidity sensors, air conditioners for plant factories, etc.

PRODUCT LINEUP

ASSEMBLY

Type	Driving range	Guaranteed measurement accuracy range	Accuracy	Driving voltage	Output voltage	Shapes	Size	
CHS-UPS	5 to 95%RH 0 to +50°C	5 to 95%RH +25°C	±3%RH	5VDC	0 to 1.0V	SQUARE TYPE	27×11.5×6.5	
CHS-UPR						ROUND TYPE	ø20×9	
CHS-UGS		20 to 85%RH +25°C	±5%RH			SQUARE TYPE	27×11.5×6.5	
CHS-UGR						ROUND TYPE	ø20×9	
CHS-MSS		50%RH +25°C	±7%RH				SQUARE TYPE	20×10×5
CHS-CGC5-28							0 to 2.0V	PCB ASSY

ELEMENT

Type	Driving range	Guaranteed measurement accuracy range	Accuracy	Driving voltage	Output impedance	Shapes	Size
CHS-ESS-CA5	5 to 95%RH 0 to +50°C	50%RH +25°C	±5%RH	AC5V max.	1k to 80M Ω (AC1V/1kHz)	SQUARE TYPE	9.0×6.5×3.7

RoHS Directive Compliant Product: See the following for more details. <https://product.tdk.com/info/en/environment/rohs/index.html>

 Please be sure to request delivery specifications that provide further details on the features and specifications of the products for proper and safe use.
 Please note that the contents may change without any prior notice due to reasons such as upgrading.

Assembly • Sensor units with built-in circuits

CHS-UPS, -UPR, -UGS, -UGR

FEATURES

- Measures a wide humidity range of 5 to 95% RH.
- High accuracy. The nominal accuracy for the CHS-UPR and -UPS within $\pm 3\%$ RH.
- The temperature characteristics are stable over a wide range.
- Humidity-sensitive characteristics exhibit virtually no hysteresis.
- Highly cost-effective and compact, requiring extremely little mounting space.
- Low current consumption.
- Outputs DC.1V at 100(%)RH; relative humidity can be read directly with a voltmeter.
- It is of an all-in-one construction that integrates all needed circuitry and operates on a 5V power supply.

SHAPE & DIMENSIONS

CHS-UPS, -UGS

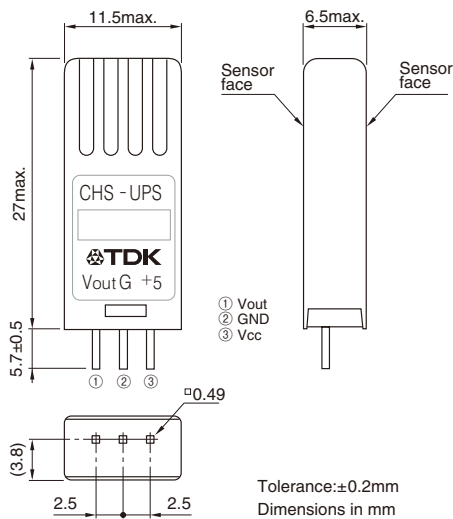

CHS-UPR, -UGR

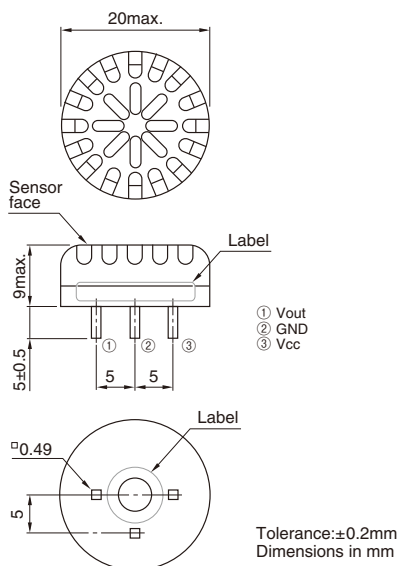

⚠ Please be sure to request delivery specifications that provide further details on the features and specifications of the products for proper and safe use.
Please note that the contents may change without any prior notice due to reasons such as upgrading.

Assembly • Sensor units with built-in circuits

CHS-UPS, -UPR, -UGS, -UGR

MAXIMUM RATINGS

Power supply voltage Edc	7V max. (Ta=25°C)
Operating conditions	0 to +50°C, power supply voltage of 5 V, no dew condensation
Storage conditions	-20 to +60°C, no dew condensation

TYPICAL ELECTRICAL CHARACTERISTICS

Item		Min.	Standard	Max.	Condition
Measurement accuracy(%RH)	CHS-UPS, -UPR	-3		+3	E _{dc} =5V, 25°C, 5 to 95%RH
	CHS-UGS, -UGR	-5		+5	E _{dc} =5V, 25°C, 5 to 95%RH
Driving voltage Edc(V)		4.75	5	5.25	
Operating current(mA)				0.6	E _{dc} =5V, 25°C
Output voltage(mV)/%RH			10		E _{dc} =5V, 25°C, 5 to 95%RH
Output impedance(kΩ)			200*		at DC
Hysteresis(%RH)			≈0		Stable time: 20min
Temperature dependency(%RH)		-5		+5	E _{dc} =5V, 25°C standard, +5 to 45°C, 5 to 95%RH
Response time(min)			1		1 Response time to reach 90% of actual humidity from 30 to 85% RH
Recommended operating temperature(°C)		+5		+45	E _{dc} =5V, no dew condensation

* Reference value

EXAMPLE OF SENSOR LINEARITY CHARACTERISTICS

CHS-UPS, -UPR

at E_{dc}=5V, Ta=25°C, 5% to 95%RH

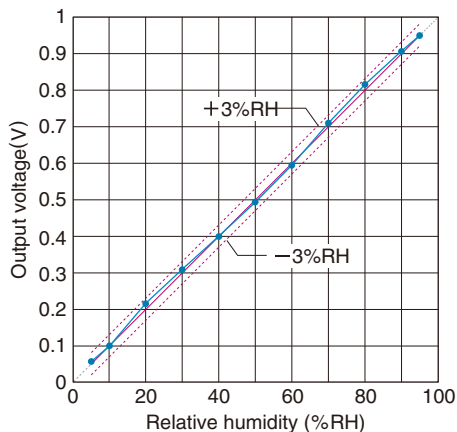

CHS-UGS, -UGR

at E_{dc}=5V, Ta=25°C, 5% to 95%RH

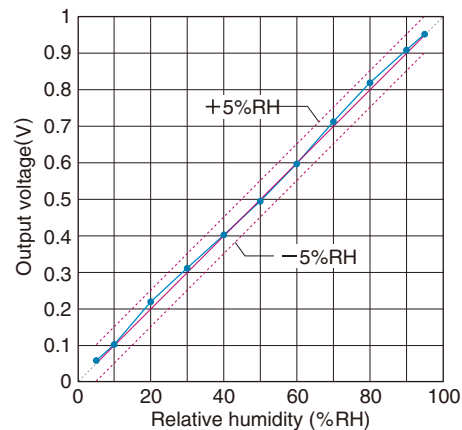

EXAMPLE OF THERMAL CHARACTERISTICS (TEMPERATURE DEPENDENCY)

at E_{dc}=5V, +5 to +45°C, 5% to 95%RH

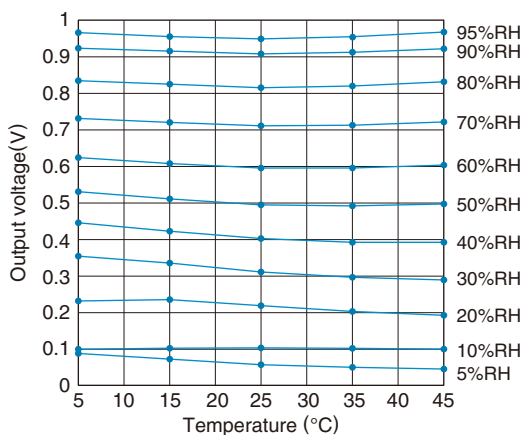

⚠ Please be sure to request delivery specifications that provide further details on the features and specifications of the products for proper and safe use.
Please note that the contents may change without any prior notice due to reasons such as upgrading.

Assembly • Sensor units with built-in circuits

CHS-MSS**FEATURES**

- A compact type that is the smallest and lightest in the series.
- Guarantees a measurement accuracy of $\pm 5\%$ RH in the humidity range of 20 to 85% RH.
- Feature low current consumption (0.6 mA with a driving voltage of 5 V at 25°C).
- Humidity-sensitive characteristics exhibit virtually no hysteresis.

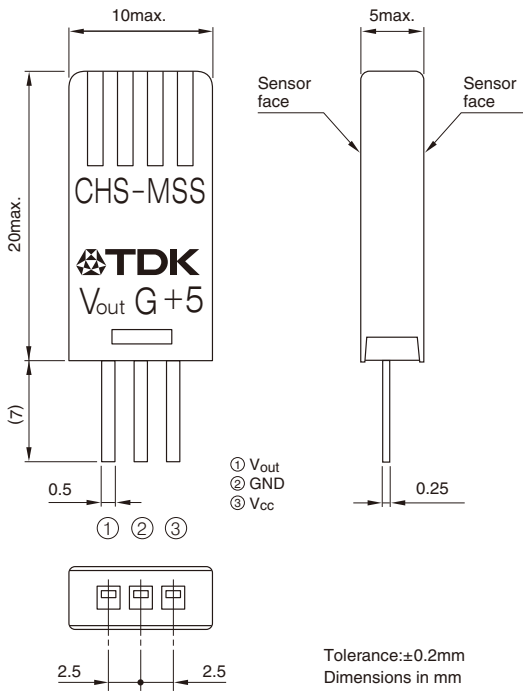
SHAPE & DIMENSIONS

Assembly • Sensor units with built-in circuits

CHS-MSS

MAXIMUM RATINGS

Power supply voltage Edc	7V max. (Ta=25°C)
Operating conditions	0 to +50°C, power supply voltage of 5 V, no dew condensation
Storage conditions	-20 to +60°C, no dew condensation

TYPICAL ELECTRICAL CHARACTERISTICS

Item	Min.	Standard	Max.	Condition
Driving voltage Edc(V)	4.75	5	5.25	
Operating current(mA)			0.6	Edc=5V, 25°C
Output voltage(mV)/%RH		10		Edc=5V, 25°C, 20 to 85%RH
Output impedance(kΩ)		200*		at DC
Measurement accuracy(%RH)	-5		+5	Edc=5V, 25°C, 20 to 85%RH
Hysteresis(%RH)		1		Stable time: 20min
Temperature dependency(%RH)	-5		+5	Edc=5V, 25°C standard, +15 to 35°C, 20 to 85%RH
Response time(min)		1		1 Response time to reach 90% of actual humidity from 30 to 85% RH
Recommended operating temperature(°C)	+15		+35	Edc=5V, no dew condensation

* Reference value

EXAMPLE OF SENSOR LINEARITY CHARACTERISTICS

at Edc=5V, Ta=25°C, 20% to 85%RH

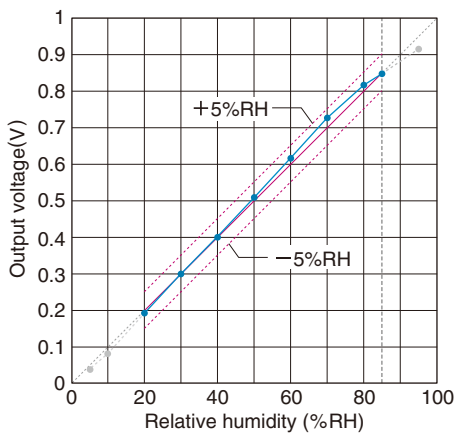

EXAMPLE OF THERMAL CHARACTERISTICS (TEMPERATURE DEPENDENCY)

at Edc=5V, +15 to +35°C, 20% to 85%RH

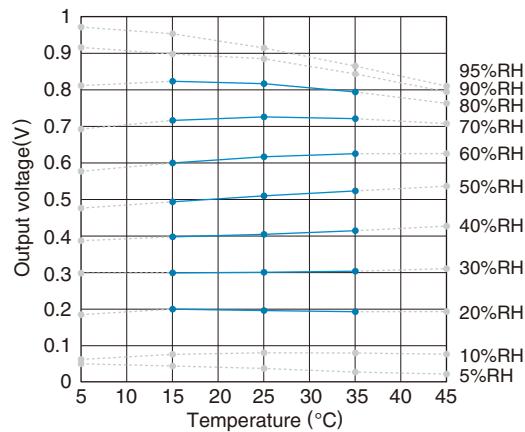

Assembly • Sensor units with built-in circuits

CHS-CGC5-28**FEATURES**

- A small sensor element and connector are mounted on a PCB on which circuits are constituted.
- Guarantees a measurement accuracy of $\pm 7\%$ RH at 50% RH in humidity.
- Allows output voltage suitable for the measured humidity to be obtained when connected to a 5V power supply.
- The hysteresis of the humidity-sensitive characteristics is about 1% RH.
- Equipped with a thermistor for humidity detection.

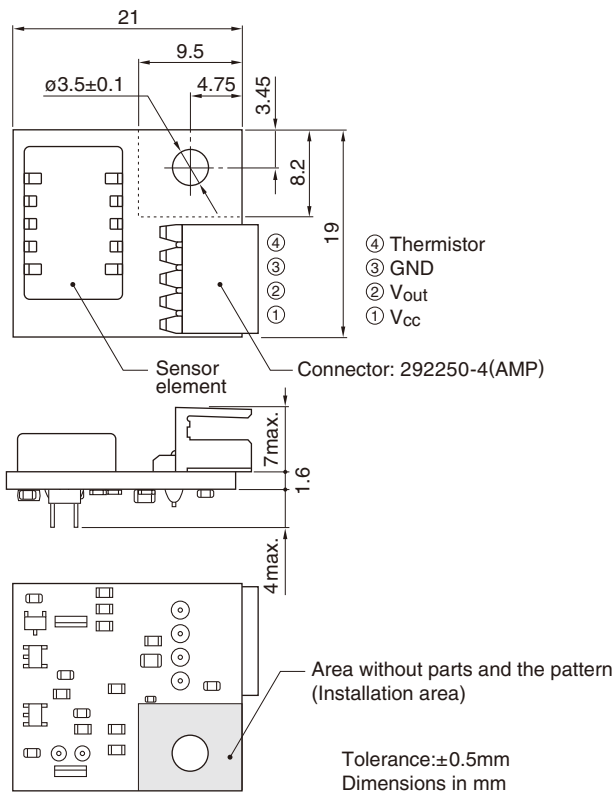
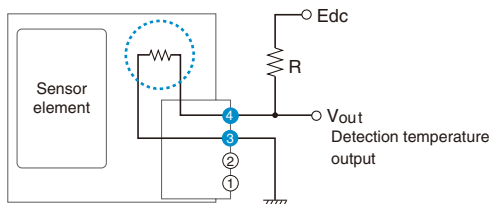
SHAPE & DIMENSIONS**BUILT-IN SENSOR (THERMISTOR) CONNECTION EXAMPLE**

Assembly • Sensor units with built-in circuits

CHS-CGC5-28**MAXIMUM RATINGS**

Power supply voltage Edc	7V max. (Ta=25°C)
Operating conditions	0 to +50°C, power supply voltage of 5 V, no dew condensation
Storage conditions	-20 to +60°C, no dew condensation

TYPICAL ELECTRICAL CHARACTERISTICS

Item	Min.	Standard	Max.	Condition
Driving voltage Edc(V)	4.75	5	5.25	
Operating current(mA)			2	E _{dc} =5V, 25°C
Output impedance(kΩ)		100*		at DC
Measurement accuracy(%RH)	-7		+7	E _{dc} =5V, 25°C, at 50%RH
	0.724V	0.89V	1.096V	
Hysteresis(%RH)		1		Stable time: 20min
Response time(min)		1		1 Response time to reach 90% of actual humidity from 30 to 85% RH

* Reference value

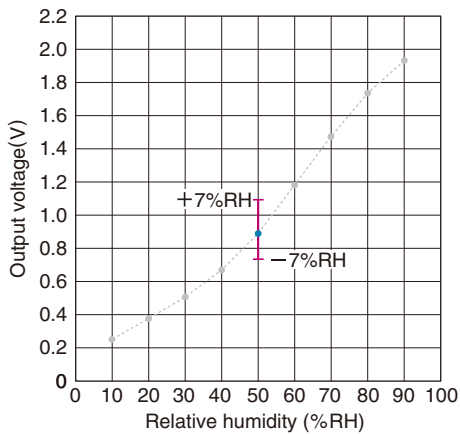
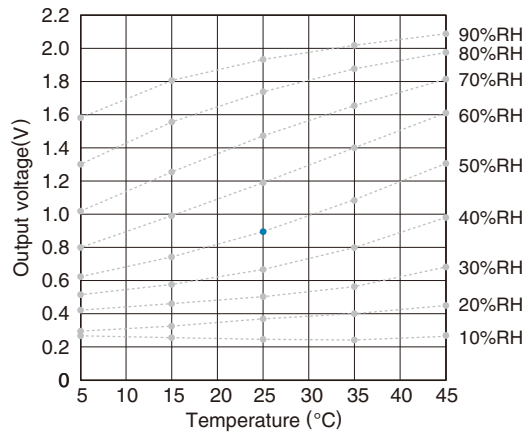
 EXAMPLE OF SENSOR LINEARITY CHARACTERISTICS
 at E_{dc}=5V, Ta=25°C, 50%RH

 EXAMPLE OF THERMAL CHARACTERISTICS (TEMPERATURE DEPENDENCY)
 at E_{dc}=5V, 25°C, 50%RH

Element

CHS-ESS-CA5**FEATURES**

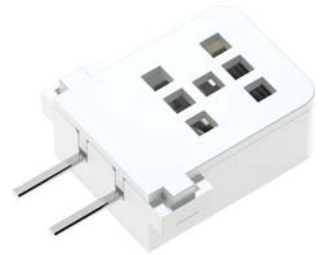
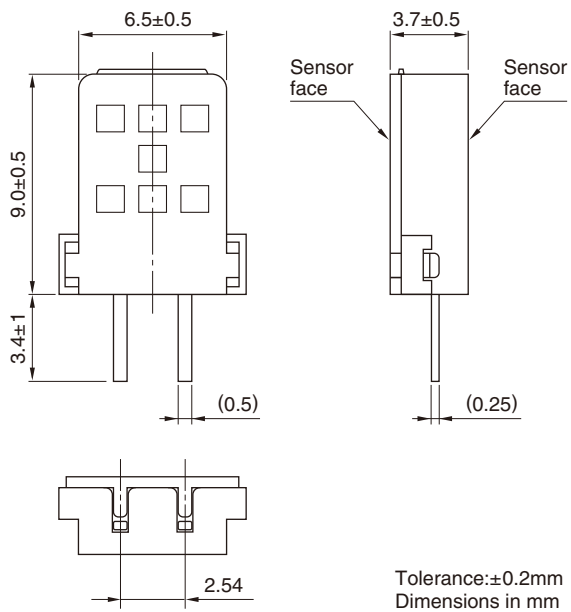
- A resistance change-type humidity sensor with superior water and gas resistance in a small package.
- Features a large impedance change in response to humidity changes and exhibits excellent responsiveness and sensitivity.
- Guarantees a measurement accuracy of $\pm 5\%$ RH at 50% RH in humidity.
- The hysteresis of the humidity-sensitive characteristics is suppressed at about 1% RH.

SHAPE & DIMENSIONS

Element

CHS-ESS-CA5

MAXIMUM RATINGS

Power supply voltage Eac	7V max. (Ta=25°C)
Operating conditions	0 to +60°C, 10 to 90%RH, no dew condensation
Storage conditions	-20 to +85°C, 5 to 95%RH, no dew condensation

TYPICAL ELECTRICAL CHARACTERISTICS

Item	Min.	Standard Max.	Condition	
Driving voltage Eac(V)		5		
Operating current(mA)		0.5		
Output impedance(kΩ)	26	40	62	25°C, at 50%RH
Measurement accuracy(%RH)	-5		+5	Eac=1V, 25°C, at 50%RH
	62kΩ	40kΩ	26kΩ	
Hysteresis(%RH)		1		
Response time(min)		1	1 Response time to reach 90% of actual humidity from 30 to 85% RH	

IMPEDANCE-HUMIDITY CHARACTERISTICS (BY TEMPERATURE)

at Eac=1V, 1kHz

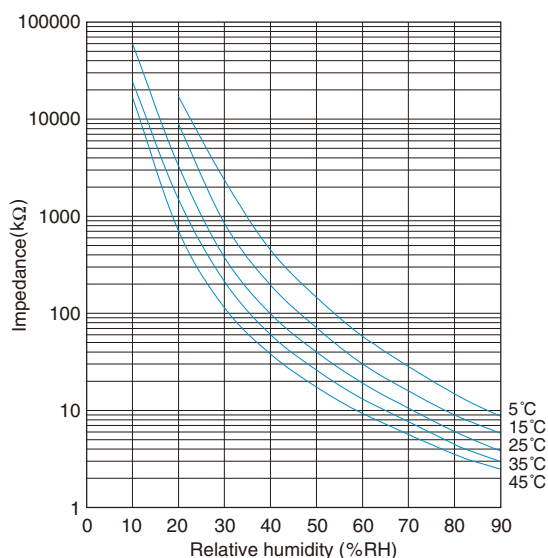

IMPEDANCE-HUMIDITY CHARACTERISTICS (BY FREQUENCY)

at Eac=1V, 25°C

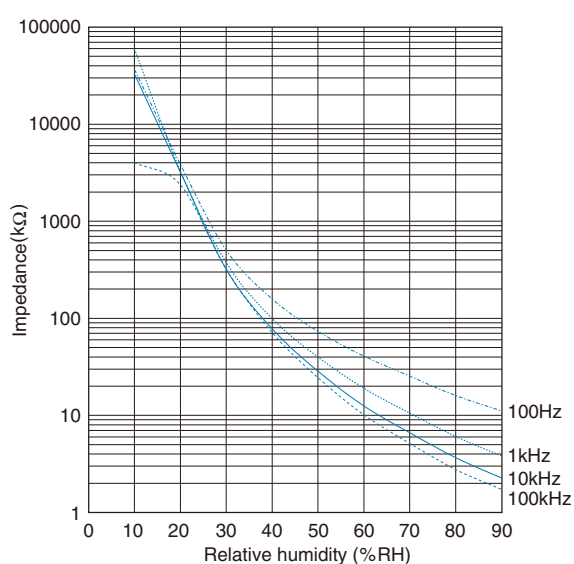

Please be sure to request delivery specifications that provide further details on the features and specifications of the products for proper and safe use. Please note that the contents may change without any prior notice due to reasons such as upgrading.

CHS series

■ Handling Precautions

For CHS series products of all types

- Please request a delivery specification form containing more detailed information on characteristics and specifications so as to ensure correct and safe use of the products.
- Operating life of the products becomes shorter depending on the environmental conditions. If you are concerned with the stable operation period, please confirm the operating life in the actual environment in advance.

[Storage Environment]

- Check the standards concerning the storage conditions described in the delivery specifications of the products, and store them in accordance with the standards.
- It is recommended that the products be stored in an airtight container with silica gel.
- Do not store this product in an environment in which corrosive gases are generated, entered, or stagnated, or in dusty environments.
- Storage in high temperature and high-humidity environments, environments where condensation occurs, or environments where sudden temperature changes occur may cause deterioration of the moisture sensitive film, resulting in fluctuations of output exceeding the guaranteed range. If the products have been stored in such environments, check their characteristics before use.
- Storage in environments where products may come into contact with water or saltwater may cause deterioration of the moisture sensitive film, resulting in fluctuations of output exceeding the guaranteed range. If the products have been stored in such environments, check their characteristics before use.
- Storage for an extended period of time may cause deterioration of the moisture sensitive film, resulting in fluctuations of output exceeding the guaranteed range. If the products have been stored for an extended period of time, check their characteristics before use.

[Usage Environment/Operating Conditions]

- As for usage environment conditions and operating conditions of the products, check the standards concerning the usage environment conditions and operating conditions described in the delivery specifications, and use the products in accordance with the standards.
- The generation, influx, or stagnation of corrosive gases or a large amount of dust may become a cause of deterioration of the moisture sensitive film, resulting in fluctuations of output exceeding the guaranteed range.
- High temperature and high humidity, condensation, or sudden temperature changes may become a cause of deterioration of the moisture sensitive film, resulting in fluctuations of output exceeding the guaranteed range.
- Environments where the products come into contact with water or saltwater may become a cause of deterioration of the moisture sensitive film, resulting in fluctuations of output exceeding the guaranteed range.

[Handling]

- Do not apply excessive mechanical shock such as dropping to the products.
- Do not cover the sensing surface of the products when mounting.
- Be careful not to apply excessive stress on the main unit when forming terminals.
- In a process such as flow soldering where flux decomposition gas is generated, take measures such as temporarily sealing the opening of the main unit to keep corrosive gas from entering (corrosive gas may become a cause of deterioration of the moisture sensitive film, resulting in fluctuations of output exceeding the guaranteed range).

Element type

[Usage Environment/Operating Conditions]

- The rated voltage of this product is "AC (Eac) 5Vmax". Please be reminded that serious damage such as electrolysis or peeling of the moisture sensitive material may occur if a direct current is applied to the products. In addition, please keep in mind that there may be effects similar to direct current application even when applying an alternating current, due to (1) residual direct current or (2) asymmetrical waveforms.

■ Other Requests/Notices

- We do not assume any responsibility for any damage caused by the use of our products exceeding the scope or conditions defined in the delivery specifications.
- Specifications of the products in this catalog are subject to change without notice due to improvements or other reasons. In addition, supply of the products may be cancelled without notice.

 Please be sure to request delivery specifications that provide further details on the features and specifications of the products for proper and safe use. Please note that the contents may change without any prior notice due to reasons such as upgrading.