

Chip beads

For general signal line

Soft termination

KMZ-HR series (for automotive)



AEC-Q200

KMZ1608-HR type



FEATURES

- Noise reduction solution for general signal line.
- Various frequency characteristics with 6 materials of different features for countermeasures against everything from general signals to high-speed signals.
- The conductive resin absorbs external stresses and improves resistance to mechanical stress and thermal shock.
- The conductive resin provides thermal stress relief and can withstand temperatures as high as 150°C.
- Operating temperature range: -55 to +150°C

APPLICATION

- Various ECUs, powertrains, body controls, and car multimedia (telematics).

PART NUMBER CONSTRUCTION

KMZ	1608	B	HR	601	C	T	DH5
Series name	LxWxT dimensions 1.6x0.8x0.6 mm 1.6x0.8x0.8 mm	Material name	Specifications (Grade)	Impedance (Ω) at 100MHz	Characteristic type	Packaging style	Internal code

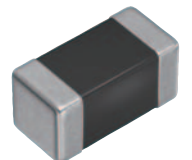

Please be sure to request delivery specifications that provide further details on the features and specifications of the products for proper and safe use. Please note that the contents may change without any prior notice due to reasons such as upgrading.

(1/7)

20200717

beads_automotive_signal_kmz1608-hr_en

KMZ1608-HR type

CHARACTERISTICS SPECIFICATION TABLE

Impedance [100MHz] (Ω)		DC resistance (Ω)max.	Rated current (mA)max.	Thickness T (mm)	Part No.
	Tolerance				
600	$\pm 25\%$	0.4	500	0.6	KMZ1608BHR601CTDH5
1000	$\pm 25\%$	0.6	300	0.8	KMZ1608BHR102CTD25
60	$\pm 25\%$	0.1	800	0.8	KMZ1608RHR600ATD25
120	$\pm 25\%$	0.18	500	0.8	KMZ1608RHR121ATD25
600	$\pm 25\%$	0.4	500	0.8	KMZ1608RHR601ATD25
1000	$\pm 25\%$	0.5	400	0.8	KMZ1608RHR102ATD25
120	$\pm 25\%$	0.15	500	0.8	KMZ1608SHR121ATD25
600	$\pm 25\%$	0.35	500	0.8	KMZ1608SHR601ATD25
1000	$\pm 25\%$	0.5	400	0.8	KMZ1608SHR102ATD25
60	$\pm 25\%$	0.15	500	0.8	KMZ1608YHR600BTD25
120	$\pm 25\%$	0.2	500	0.8	KMZ1608YHR121BTD25
300	$\pm 25\%$	0.3	500	0.8	KMZ1608YHR301BTD25
600	$\pm 25\%$	0.4	500	0.8	KMZ1608YHR601BTD25
1000	$\pm 25\%$	0.5	400	0.8	KMZ1608YHR102BTD25
1500	$\pm 25\%$	0.6	300	0.8	KMZ1608YHR152BTD25
2500	$\pm 25\%$	0.8	200	0.8	KMZ1608AHR252BTD25
50	$\pm 25\%$	0.25	500	0.6	KMZ1608DHR500CTDH5
120	$\pm 25\%$	0.3	400	0.6	KMZ1608DHR121CTDH5
240	$\pm 25\%$	0.6	300	0.8	KMZ1608DHR241CTD25

* Please refer to the graph of rated current vs. temperature characteristics (derating) about the rating current at 125°C or more in temperature of the product.

Measurement equipment

Measurement item	Product No.	Manufacturer
Impedance	E4991A+16192A	Keysight Technologies
DC resistance	Type-7556	Yokogawa

* Equivalent measurement equipment may be used.

Rated current vs. temperature characteristics (derating)

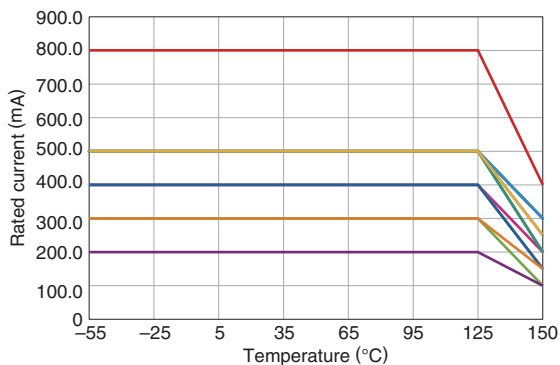

— RHR600A	— RHR121A, SHR121A, YHR600B, YHR121B,
— YHR301B, DHR500C	— BHR601C, RHR601A, SHR601A, YHR601B
— SHR102A	— RHR102A, YHR102B, DHR121C
— BHR102C, DHR241C	— YHR152B
	— AHR252B

KMZ1608-HR type

Z VS. FREQUENCY CHARACTERISTICS (BY SERIES)

KMZ1608BHR series

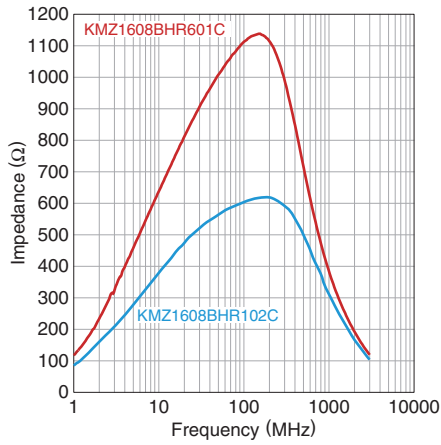

KMZ1608RHR series

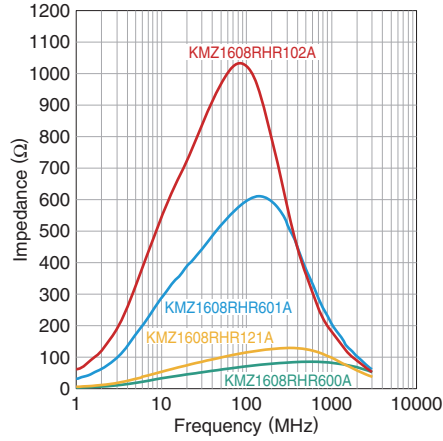

KMZ1608SHR series

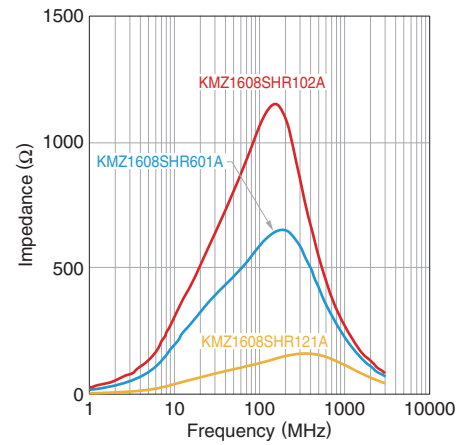

KMZ1608YHR series

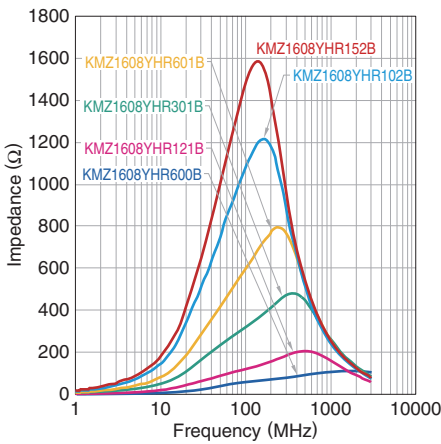

KMZ1608AHR series

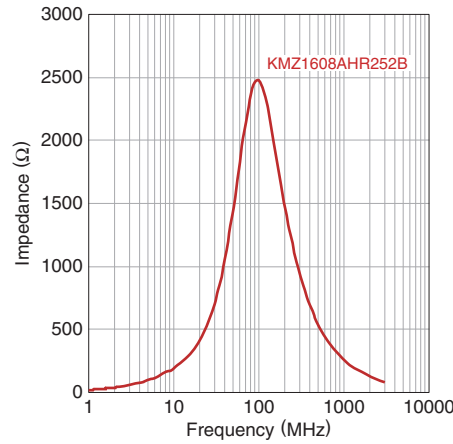

KMZ1608DHR series

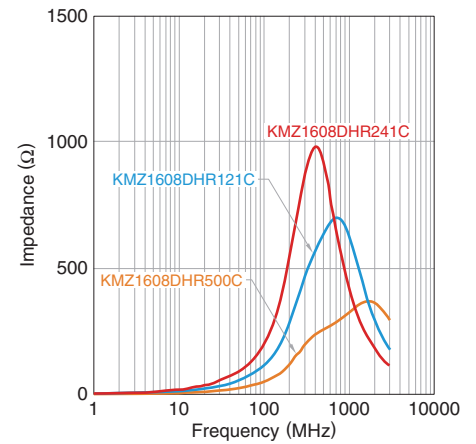

KMZ1608-HR type

Z, X, R VS. FREQUENCY CHARACTERISTICS

KMZ1608BHR601CTDH5

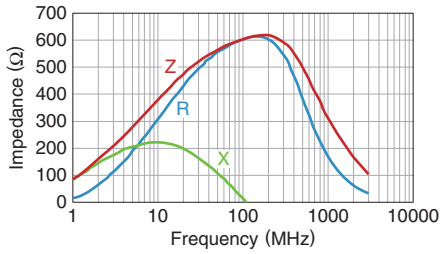

KMZ1608BHR102CTD25

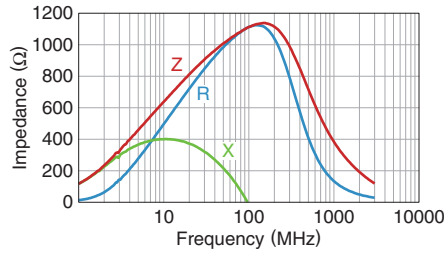

KMZ1608RHR600ATD25

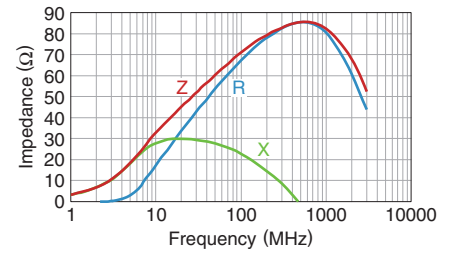

KMZ1608RHR121ATD25

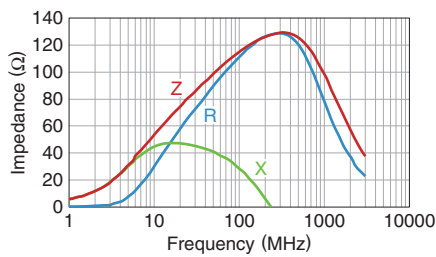

KMZ1608RHR601ATD25

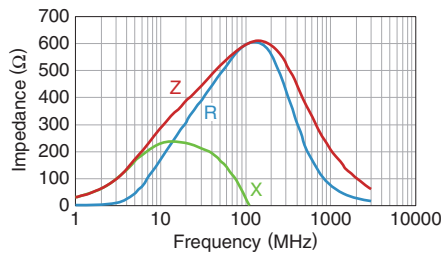

KMZ1608RHR102ATD25

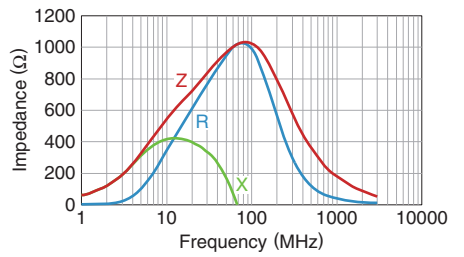

KMZ1608SHR121ATD25

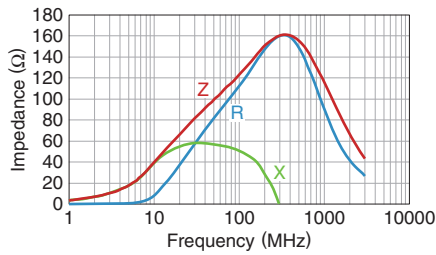

KMZ1608SHR601ATD25

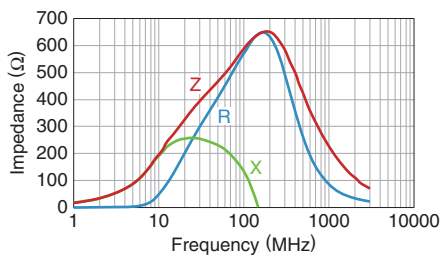

KMZ1608SHR102ATD25

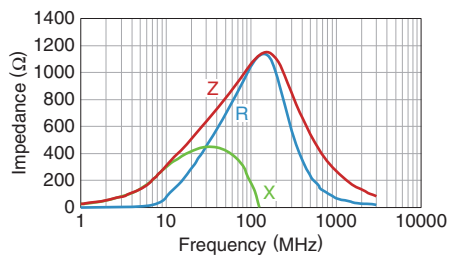

KMZ1608YHR600BTD25

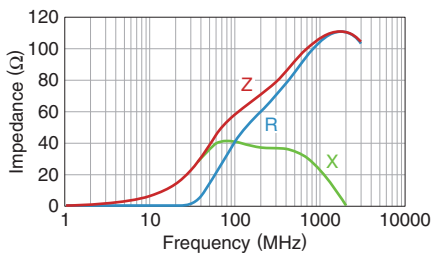

KMZ1608YHR121BTD25

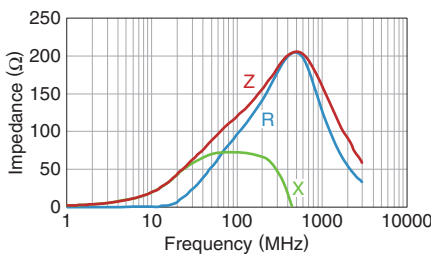

KMZ1608YHR301BTD25

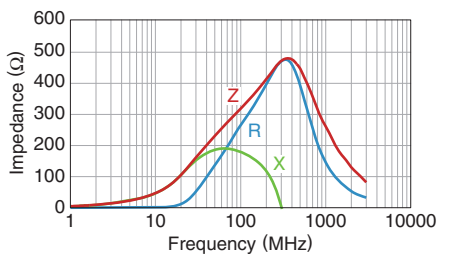

KMZ1608YHR601BTD25

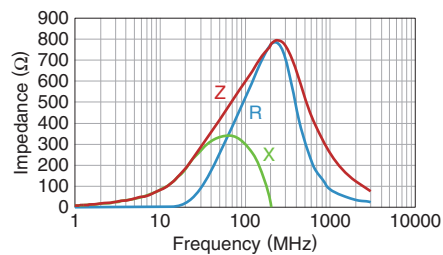

KMZ1608YHR102BTD25

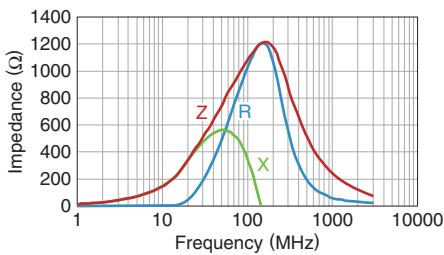

KMZ1608YHR152BTD25

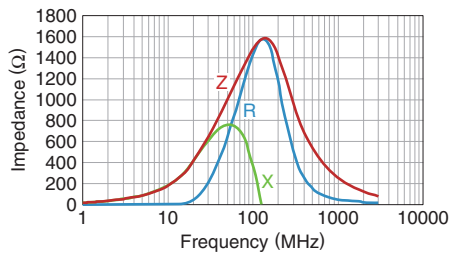

⚠ Please be sure to request delivery specifications that provide further details on the features and specifications of the products for proper and safe use. (4/7)
Please note that the contents may change without any prior notice due to reasons such as upgrading.

20200717

beads_automotive_signal_kmz1608-hr_en

KMZ1608-HR type

Z, X, R VS. FREQUENCY CHARACTERISTICS

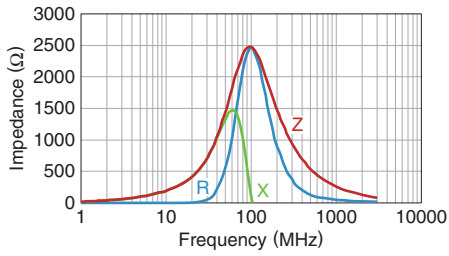
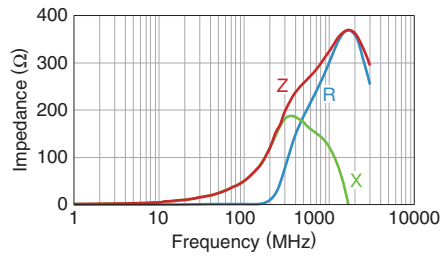
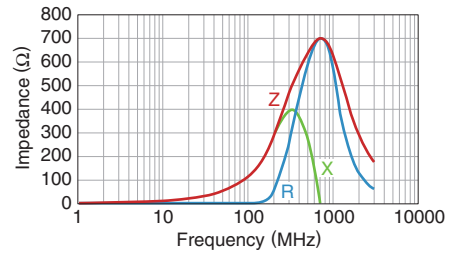
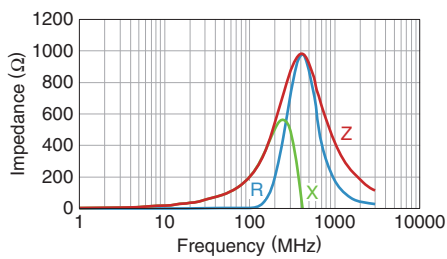
KMZ1608AHR252BTD25**KMZ1608DHR500CTDH5****KMZ1608DHR121CTDH5****KMZ1608DHR241CTD25**

KMZ1608-HR type

SHAPE & DIMENSIONS

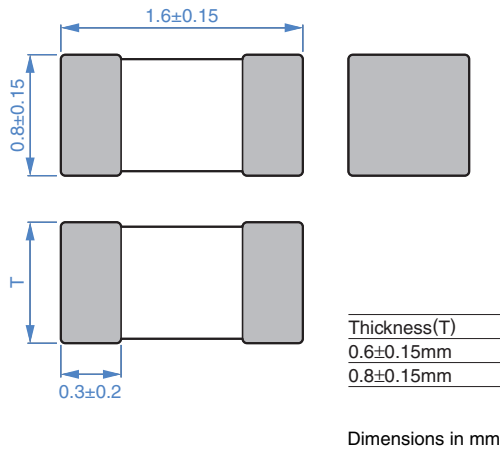

PACKAGING STYLE

REEL DIMENSIONS

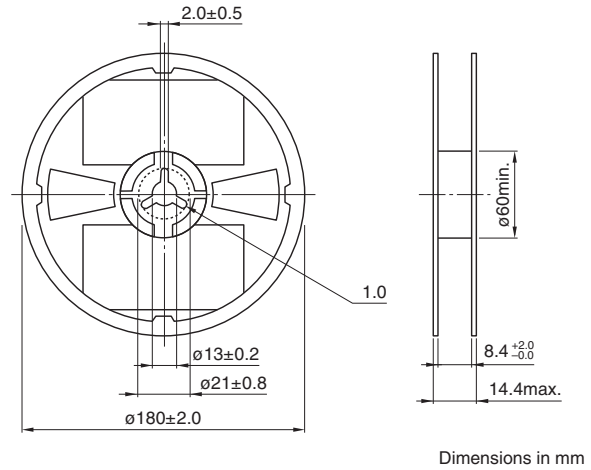

RECOMMENDED LAND PATTERN

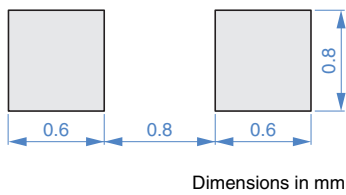

TAPE DIMENSIONS

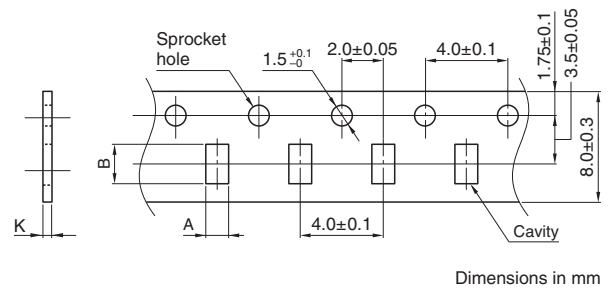

RECOMMENDED REFLOW PROFILE

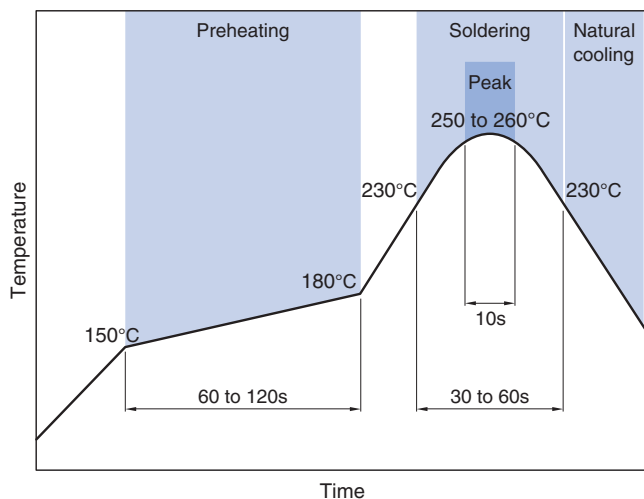

Type	A	B	K
KMZ1608-HR	1.1±0.2	1.9±0.2	1.1max.

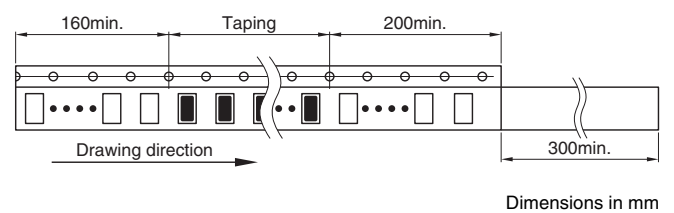

PACKAGE QUANTITY

Package quantity	4,000 pcs/reel
------------------	----------------

TEMPERATURE RANGE, INDIVIDUAL WEIGHT

Type	Operating temperature range	Storage temperature range*	Individual weight
t=0.6mm (DH5)	-55 to +150 °C	-55 to +150 °C	3 mg
t=0.8mm (D25)	-55 to +150 °C	-55 to +150 °C	4 mg

* The storage temperature range is for after the assembly.

REMINDERS FOR USING THESE PRODUCTS

Before using these products, be sure to request the delivery specifications.

SAFETY REMINDERS

Please pay sufficient attention to the warnings for safe designing when using this products.

REMINDERS

- The storage period is within 12 months. Be sure to follow the storage conditions (temperature: 5 to 40°C, humidity: 10 to 75% RH or less).
If the storage period elapses, the soldering of the terminal electrodes may deteriorate.
- Do not use or store in locations where there are conditions such as gas corrosion (salt, acid, alkali, etc.).
- Before soldering, be sure to preheat components.
The preheating temperature should be set so that the temperature difference between the solder temperature and chip temperature does not exceed 150°C.
- Soldering corrections after mounting should be within the range of the conditions determined in the specifications.
If overheated, a short circuit, performance deterioration, or lifespan shortening may occur.
- When embedding a printed circuit board where a chip is mounted to a set, be sure that residual stress is not given to the chip due to the overall distortion of the printed circuit board and partial distortion such as at screw tightening portions.
- Self heating (temperature increase) occurs when the power is turned ON, so the tolerance should be sufficient for the set thermal design.
- Carefully lay out the coil for the circuit board design of the non-magnetic shield type.
A malfunction may occur due to magnetic interference.
- Use a wrist band to discharge static electricity in your body through the grounding wire.
- Do not expose the products to magnets or magnetic fields.
- Do not use for a purpose outside of the contents regulated in the delivery specifications.
- The products described in this catalog are intended to be installed in automobiles or automotive electronic equipment (AV equipment, telecommunications equipment, home appliances, amusement equipment, computer equipment, personal equipment, office equipment, measurement equipment, industrial robots) and to be used in automobiles (including the case where the said automotive product is mounted in a vehicle) or standard applications as general electronic equipment in automotive applications or standard applications as general electronic equipment in automotive applications in accordance with the scope and conditions described in this specification, while the said automotive or general electronic equipment including the said product is intended to be used in the usual operation and usage methods, respectively. Other than automotive or automotive products are not designed or warranted to meet the requirements of the applications listed below, whose performance and/or quality requires a more stringent level of safety or reliability, or whose failure, malfunction or defect could cause serious damage to society, person or property.

Please understand that we are not responsible for any damage or liability caused by use of the products in any of the applications below or for any other use exceeding the range or conditions set forth in this specification sheet.

If you intend to use the products in the applications listed below or if you have special requirements exceeding the range or conditions set forth in this specification, please contact us.

- | | |
|---|--|
| (1) Aerospace/aviation equipment | (8) Public information-processing equipment |
| (2) Transportation equipment (electric trains, ships, etc.) | (9) Military equipment |
| (3) Medical equipment | (10) Electric heating apparatus, burning equipment |
| (4) Power-generation control equipment | (11) Disaster prevention/crime prevention equipment |
| (5) Atomic energy-related equipment | (12) Safety equipment |
| (6) Seabed equipment | (13) Other applications that are not considered general-purpose applications |
| (7) Transportation control equipment | |

When designing your equipment even for general-purpose applications, you are kindly requested to take into consideration securing protection circuit/device or providing backup circuits in your equipment.