

FEATURES

- Controls supply rails from 2.7 V to 16.5 V
- Allows protected board removal and insertion to a live backplane
- Internal sense resistor provides adjustable analog current limit with circuit breaker
- Peak fault current limited with fast response
- Charge pumped gate drive for external N-FET switch
- Automatic retry or latch-off during current fault
- Undervoltage lockout
- Low profile (1 mm), 6-lead, TSOT package
- Pin compatible with LTC4210-1 and LTC4210-2

APPLICATIONS

- Hot swap board insertion: line cards, raid systems
- Industrial high-side switches/circuit breakers
- Electronic circuit breakers

GENERAL DESCRIPTION

The [ADM4210](#) is a hot swap controller that safely enables a printed circuit board to be removed and inserted to a live backplane. This is achieved using an external N-channel power MOSFET with a current control loop that monitors the load current through a sense resistor. An internal charge pump is used to enhance the gate of the N-channel FET. When an overcurrent condition is detected, the gate voltage of the FET is reduced to limit the current flowing through the sense resistor. During an overcurrent condition, the TIMER cap determines the amount of time the FET remains at a current limiting mode of operation until it is shut down. The ON (ON-CLR) pin is the enable input for the device and can be used to monitor the input supply voltage. The [ADM4210](#) operates with a supply voltage ranging from 2.7 V to 16.5 V.

The [ADM4210](#) is available in two options: the [ADM4210-1](#) with automatic retry for overcurrent fault and the [ADM4210-2](#) with latch off for an overcurrent fault. Toggling the ON (ON-CLR) pin resets a latched fault. The [ADM4210](#) is packaged in a 6-lead TSOT.

FUNCTIONAL BLOCK DIAGRAM

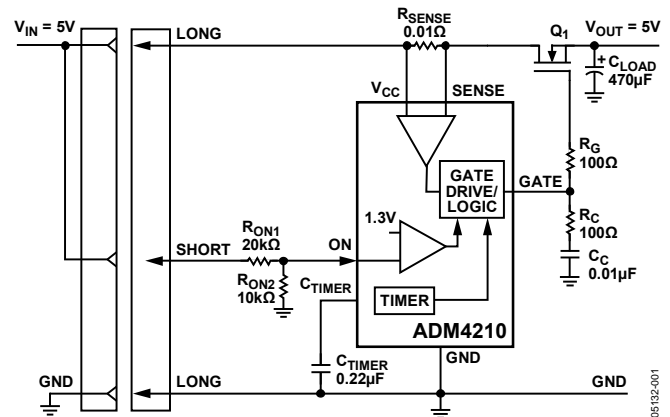

Figure 1.

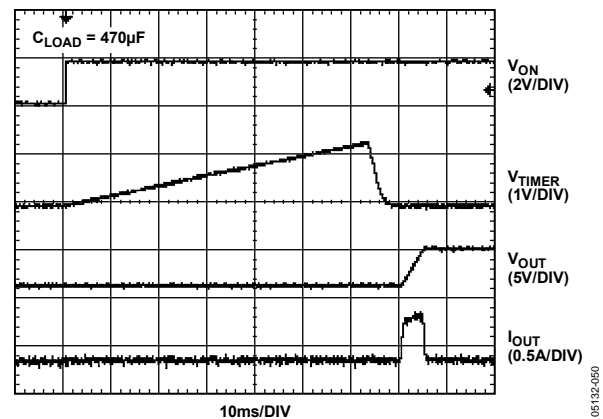

Figure 2. Start-Up Sequence

Rev. A

[Document Feedback](#)

Information furnished by Analog Devices is believed to be accurate and reliable. However, no responsibility is assumed by Analog Devices for its use, nor for any infringements of patents or other rights of third parties that may result from its use. Specifications subject to change without notice. No license is granted by implication or otherwise under any patent or patent rights of Analog Devices. Trademarks and registered trademarks are the property of their respective owners.

One Technology Way, P.O. Box 9106, Norwood, MA 02062-9106, U.S.A.
 Tel: 781.329.4700 ©2006–2013 Analog Devices, Inc. All rights reserved.
[Technical Support](#) www.analog.com

ADM4210* PRODUCT PAGE QUICK LINKS

Last Content Update: 12/18/2017

[COMPARABLE PARTS](#)

View a parametric search of comparable parts.

[DOCUMENTATION](#)

Data Sheet

- [ADM4210: Hot Swap Controller in 6-Lead TSOT Package Data Sheet](#)

[REFERENCE MATERIALS](#)

Solutions Bulletins & Brochures

- [Hot Swap And Power Monitoring Bulletin](#)

[DESIGN RESOURCES](#)

- [ADM4210 Material Declaration](#)
- [PCN-PDN Information](#)
- [Quality And Reliability](#)
- [Symbols and Footprints](#)

[DISCUSSIONS](#)

View all ADM4210 EngineerZone Discussions.

[SAMPLE AND BUY](#)

Visit the product page to see pricing options.

[TECHNICAL SUPPORT](#)

Submit a technical question or find your regional support number.

[DOCUMENT FEEDBACK](#)

Submit feedback for this data sheet.

This page is dynamically generated by Analog Devices, Inc., and inserted into this data sheet. A dynamic change to the content on this page will not trigger a change to either the revision number or the content of the product data sheet. This dynamic page may be frequently modified.

TABLE OF CONTENTS

Features	1	UVLO.....	11
Applications.....	1	ON (ON- $\overline{\text{CLR}}$) Pin.....	11
General Description	1	GATE	11
Functional Block Diagram	1	Current Limit Function.....	11
Revision History	2	Calculating the Current Limit	11
Specifications.....	3	Circuit Breaker Function.....	12
Absolute Maximum Ratings.....	4	Timer Function.....	12
Thermal Characteristics	4	Power-Up Timing Cycle	12
ESD Caution.....	4	Circuit Breaker Timing Cycle.....	13
Pin Configurations and Function Descriptions	5	Automatic Retry or Latched Off.....	13
Typical Performance Characteristics	6	Outline Dimensions	14
Theory of Operation	11	Ordering Guide	14
Overview.....	11		

REVISION HISTORY

11/13—Rev. 0 to Rev. A

Changes to Figure 33.....	13
---------------------------	----

7/06—Revision 0: Initial Version

SPECIFICATIONS

$V_{CC} = 2.7\text{ V to }16.5\text{ V}$, $T_A = -40^\circ\text{C to }+85^\circ\text{C}$, typical values at $T_A = 25^\circ\text{C}$, unless otherwise noted.

Table 1.

Parameter	Symbol	Min	Typ	Max	Unit	Conditions
V_{CC} PIN						
Operating Voltage Range	V_{CC}	2.7		16.5	V	
Supply Current	I_{CC}		0.65	3.5	mA	
Undervoltage Lockout	V_{UVLO}	2.2	2.5	2.65	V	V_{CC} rising
Undervoltage Lockout Hysteresis	$V_{UVLOHYS}$		100		mV	
ON (ON-CLR) PIN						
Input Current	I_{INON}	-10	0	+10	μA	
Threshold	V_{ON}	1.22	1.3	1.38	V	ON rising
Threshold Hysteresis	V_{ONHYS}		80		mV	
SENSE PIN						
Input Current	$I_{INSENSE}$	-10	+5	+10	μA	$V_{SENSE} = V_{CC}$
Circuit Breaker Limit Voltage	V_{CB}	44	50	56	mV	$V_{CB} = (V_{CC} - V_{SENSE})$
GATE PIN						
Pull-Up Current	I_{GATEUP}	-5	-10	-15	μA	$V_{GATE} = 0\text{ V}$
Pull-Down Current	I_{GATEDN}		25		mA	$V_{TIMER} = 1.5\text{ V}$, $V_{GATE} = 3\text{ V}$ or $V_{ON} = 0\text{ V}$, $V_{GATE} = 3\text{ V}$ or $V_{CC} - V_{SENSE} = 100\text{ mV}$, $V_{GATE} = 3\text{ V}$
Gate Drive Voltage	V_{GATE}	4.5	7.5	10	V	$V_{GATE} - V_{CC}$, $V_{CC} = 3\text{ V}$
		5.0	8.5	12	V	$V_{GATE} - V_{CC}$, $V_{CC} = 3.3\text{ V}$
		8.75	12	16	V	$V_{GATE} - V_{CC}$, $V_{CC} = 5\text{ V}$
		7.6	12	16	V	$V_{GATE} - V_{CC}$, $V_{CC} = 12\text{ V}$
		6.0	11	18	V	$V_{GATE} - V_{CC}$, $V_{CC} = 15\text{ V}$
TIMER PIN						
Pull-Up Current	$I_{TIMERUP}$	-2	-5	-8.5	μA	Initial cycle, $V_{TIMER} = 1\text{ V}$
		-25	-60	-100	μA	During current fault, $V_{TIMER} = 1\text{ V}$
Pull-Down Current	$I_{TIMERDN}$		2	3.5	μA	After current fault, $V_{TIMER} = 1\text{ V}$
			100		μA	Normal operation, $V_{TIMER} = 1\text{ V}$
Threshold High	V_{TIMERH}	1.22	1.3	1.38	V	TIMER rising
Threshold Low	V_{TIMERL}	0.15	0.2	0.25	V	TIMER falling
t_{OFF}						
Turn-Off Time (TIMER Rise to GATE Fall)	$t_{OFF(TMRHIGH)}$		1		μs	$V_{TIMER} = 0\text{ V to }2\text{ V step}$, $V_{CC} = V_{ON} = 5\text{ V}$
Turn-Off Time (ON (ON-CLR) Fall to GATE Fall)	$t_{OFF(ONLOW)}$		30		μs	$V_{ON} = 5\text{ V to }0\text{ V step}$, $V_{CC} = 5\text{ V}$
Turn-Off Time (V_{CC} Rise to IC Reset)	$t_{OFF(VCCLOW)}$		30		μs	$V_{CC} = 0\text{ V to }2\text{ V step}$, $V_{ON} = 5\text{ V}$

ABSOLUTE MAXIMUM RATINGS

Table 2.

Parameter	Rating
V _{CC} Pin	-0.3 V to +20 V
SENSE Pin	-0.3 V to +20 V
V _{CC} – SENSE	±5 V
TIMER Pin	-0.3 V to (V _{CC} + 0.3 V)
ON (ON- $\overline{\text{CLR}}$) Pin	-0.3 V to +20 V
GATE Pin	-0.3 V to (V _{CC} + 11 V)
Storage Temperature Range	-65°C to +125°C
Operating Temperature Range	-40°C to +85°C
Lead Temperature (10 sec)	300°C
Junction Temperature	150°C

Stresses above those listed under Absolute Maximum Ratings may cause permanent damage to the device. This is a stress rating only; functional operation of the device at these or any other conditions above those indicated in the operational section of this specification is not implied. Exposure to absolute maximum rating conditions for extended periods may affect device reliability.

THERMAL CHARACTERISTICS

θ_{JA} is specified for the worst-case conditions, that is, a device soldered in a circuit board for surface-mount packages.

Table 3. Thermal Resistance

Package Type	θ_{JA}	Unit
6-Lead TSOT	169.5	°C/W

ESD CAUTION

ESD (electrostatic discharge) sensitive device. Electrostatic charges as high as 4000V readily accumulate on the human body and test equipment and can discharge without detection. Although this product features proprietary ESD protection circuitry, permanent damage may occur on devices subjected to high energy electrostatic discharges. Therefore, proper ESD precautions are recommended to avoid performance degradation or loss of functionality.



PIN CONFIGURATIONS AND FUNCTION DESCRIPTIONS

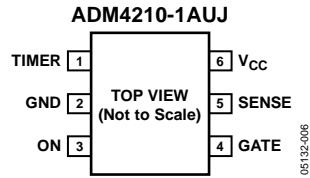

Figure 3. Pin Configuration, 1AUJ Model

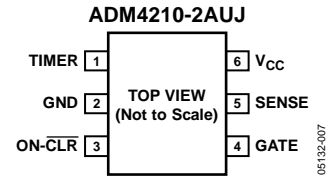

Figure 4. Pin Configuration, 2AUJ Model

Table 4. Pin Function Descriptions

Pin No.	Mnemonic	Description
1	TIMER	Timer Input Pin. The initial and circuit breaker timing cycles are set by this external capacitor. The initial timing delay is 272.9 ms/ μ F, and 21.7 ms/ μ F for a circuit breaker delay. When the TIMER pin is pulled beyond the upper threshold, the GATE turns off.
2	GND	Chip Ground Pin.
3	ON (ON- $\overline{\text{CLR}}$)	Input Pin. The ON (ON- $\overline{\text{CLR}}$) pin is an input to a comparator that has a low-to-high threshold of 1.3 V with 80 mV hysteresis and a glitch filter. The ADM4210 is reset when the ON (ON- $\overline{\text{CLR}}$) pin is low. When the ON (ON- $\overline{\text{CLR}}$) pin is high, the ADM4210 is enabled. A rising edge on this pin has the added function of clearing a fault and restarting the device on the latched off model, the ADM4210-2.
4	GATE	Gate Output Pin. An internal charge pump provides a 12 μ A pull-up current to drive the gate of an N-channel MOSFET. In an overcurrent condition, the ADM4210 controls the external FET to maintain a constant load current.
5	SENSE	Current Limit Sense Input Pin. The current limit is set via a sense resistor between the V_{CC} and SENSE pins. In an overcurrent condition, the gate of the FET is controlled to maintain the SENSE voltage at 50 mV. When this limit is reached, the TIMER circuit breaker mode is activated. The circuit breaker limit can be disabled by connecting the V_{CC} pin and SENSE pin together.
6	V_{CC}	Positive Supply Input Pin. The ADM4210 operates between 2.7 V to 16.5 V. An undervoltage lockout (UVLO) circuit with a glitch filter resets the ADM4210 when the supply voltage drops below the specified UVLO limit.

TYPICAL PERFORMANCE CHARACTERISTICS

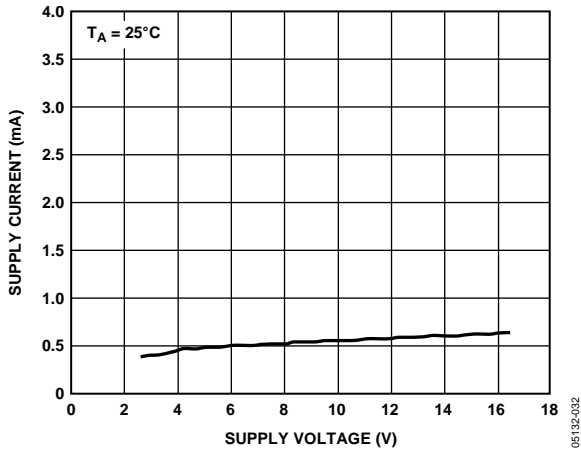

Figure 5. Supply Current vs. Supply Voltage

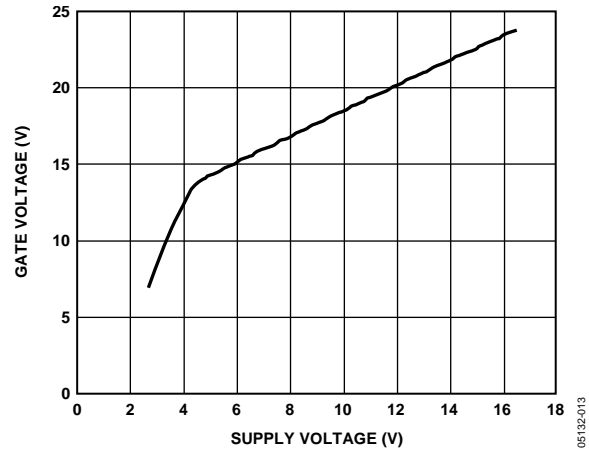

Figure 8. GATE Voltage vs. Supply Voltage

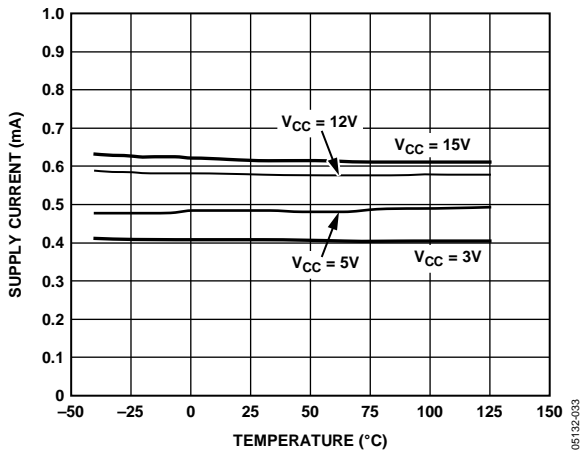

Figure 6. Supply Current vs. Temperature

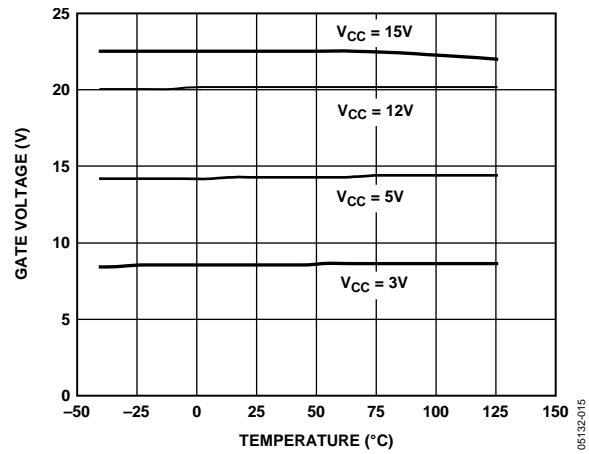

Figure 9. GATE Voltage vs. Temperature

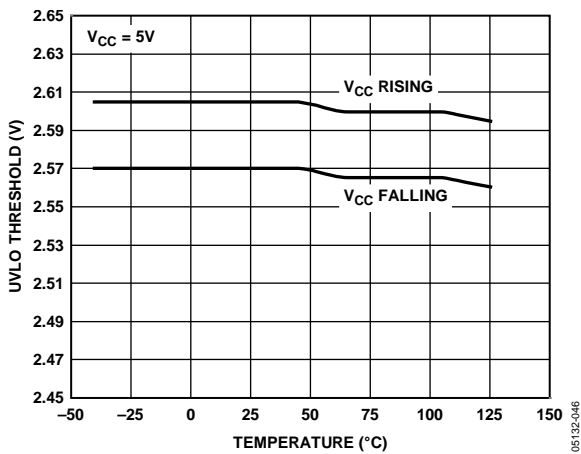

Figure 7. UVLO Threshold vs. Temperature

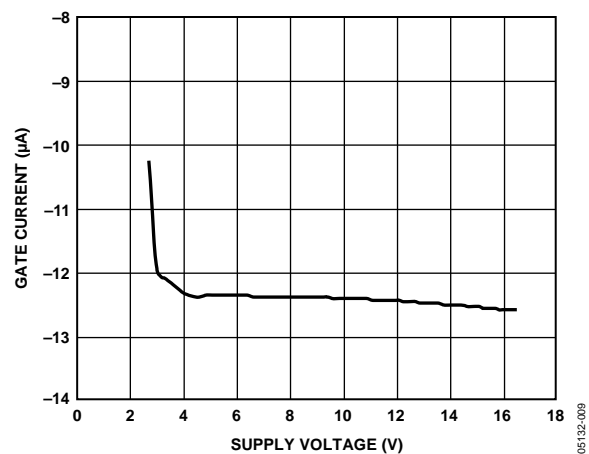

Figure 10. GATE Current (up) vs. Supply Voltage

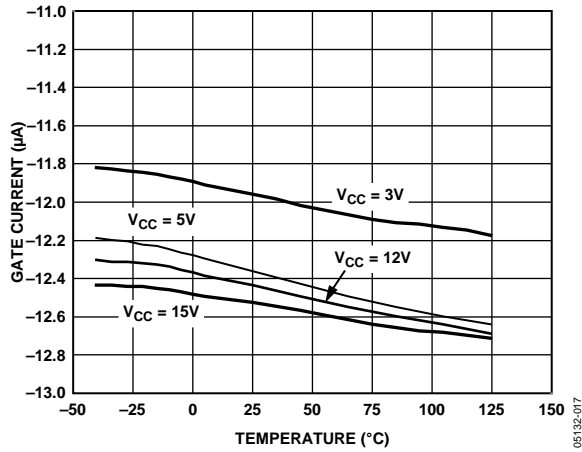

Figure 11. GATE Current (up) vs. Temperature

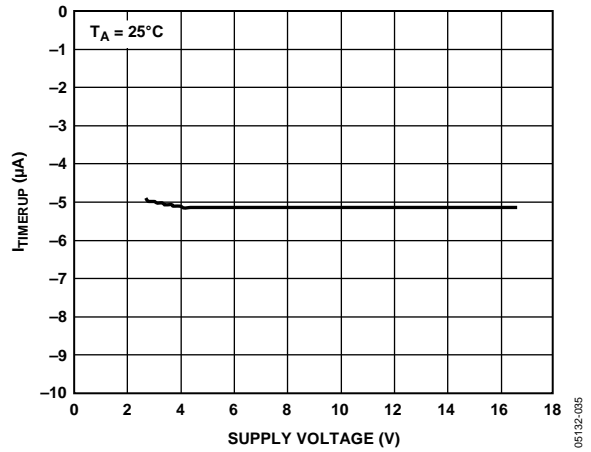

Figure 14. I_{TIMERUP} (in Initial Cycle) vs. Supply Voltage

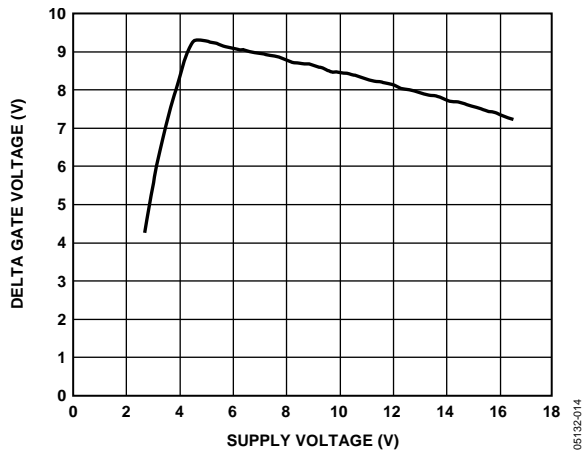

Figure 12. Delta GATE Voltage vs. Supply Voltage

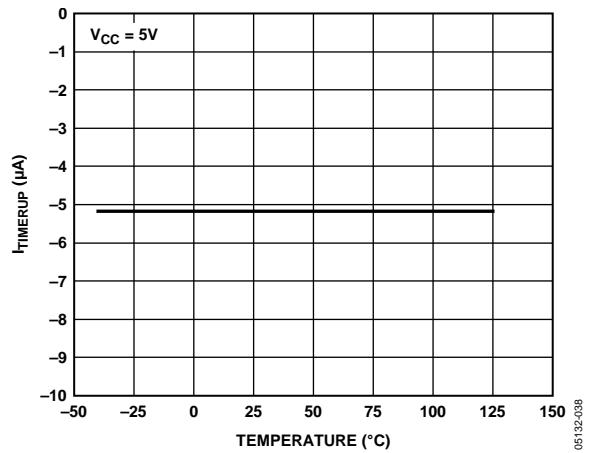

Figure 15. I_{TIMERUP} (in Initial Cycle) vs. Temperature

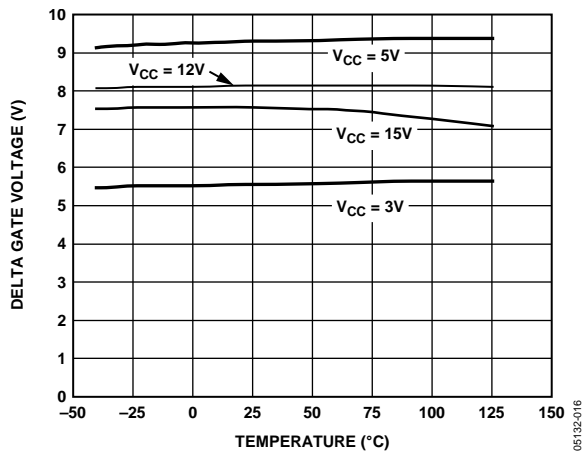

Figure 13. Delta GATE Voltage vs. Temperature

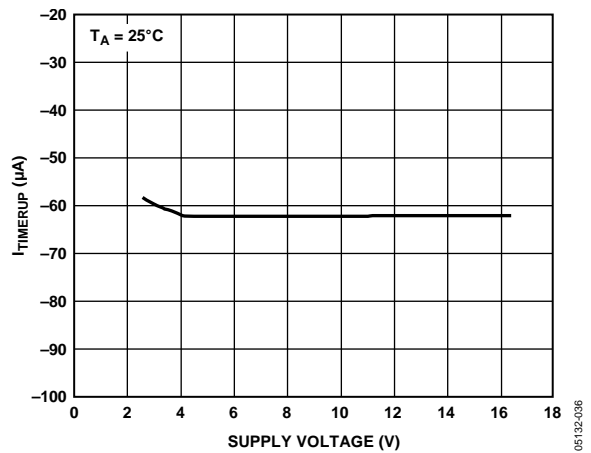

Figure 16. I_{TIMERUP} (During Cct Breaker Delay) vs. Supply Voltage

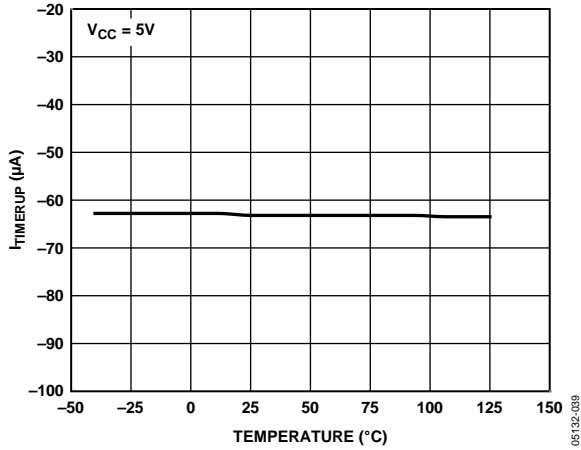

Figure 17. $I_{TIMERUP}$ (During Cct Breaker Delay) vs. Temperature

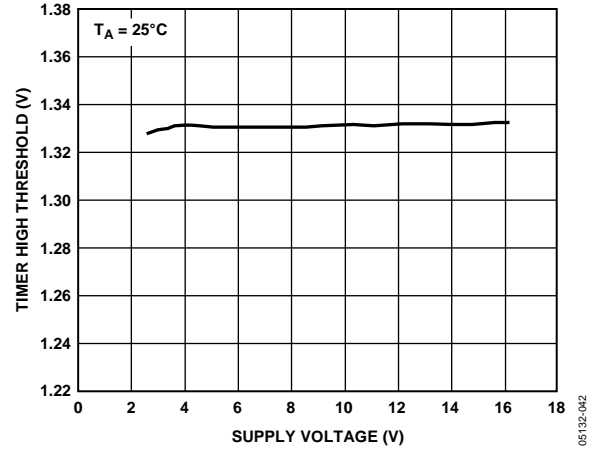

Figure 20. TIMER High Threshold vs. Supply Voltage

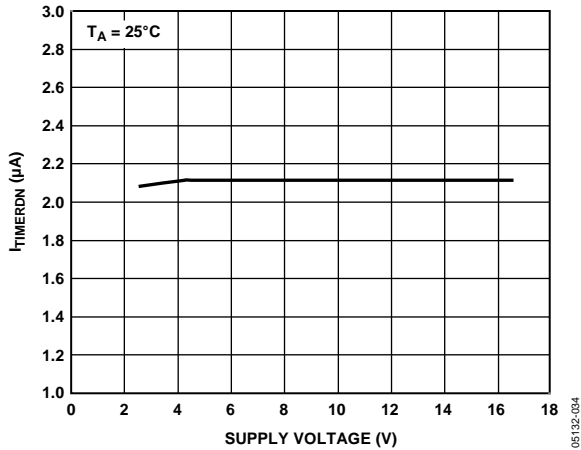

Figure 18. $I_{TIMERDN}$ (in Cool-Off Cycle) vs. Supply Voltage

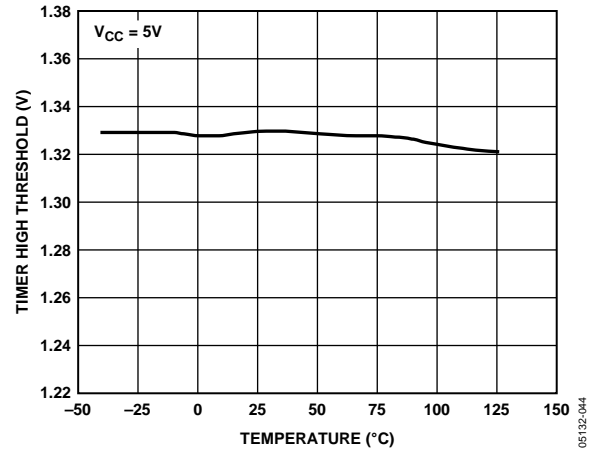

Figure 21. TIMER High Threshold vs. Temperature

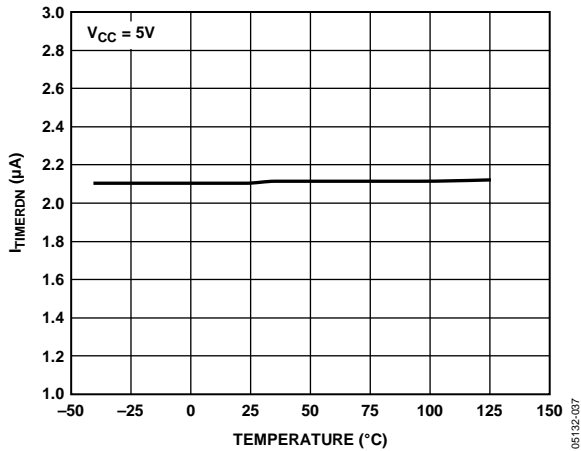

Figure 19. $I_{TIMERDN}$ (in Cool-Off Cycle) vs. Temperature

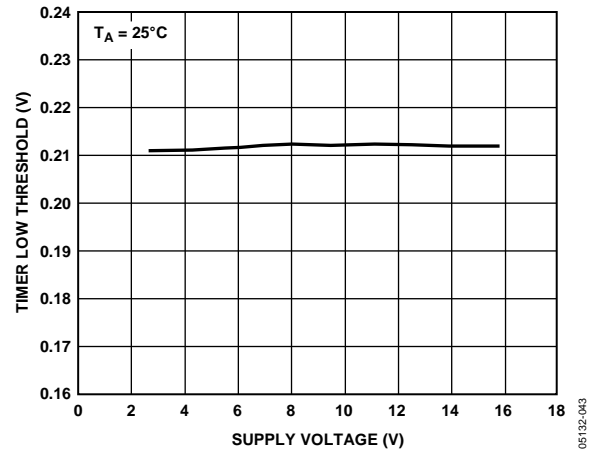

Figure 22. TIMER Low Threshold vs. Supply Voltage

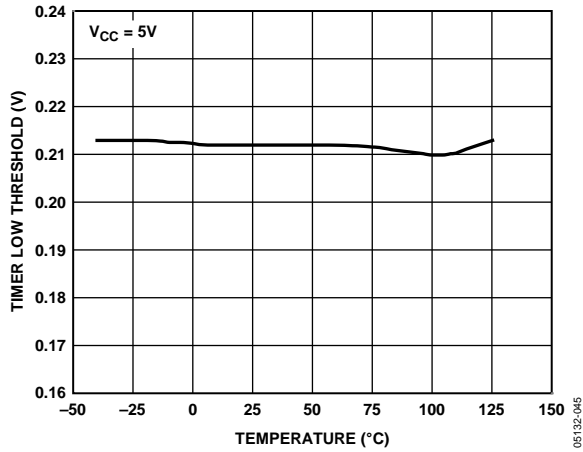

Figure 23. TIMER Low Threshold vs. Temperature

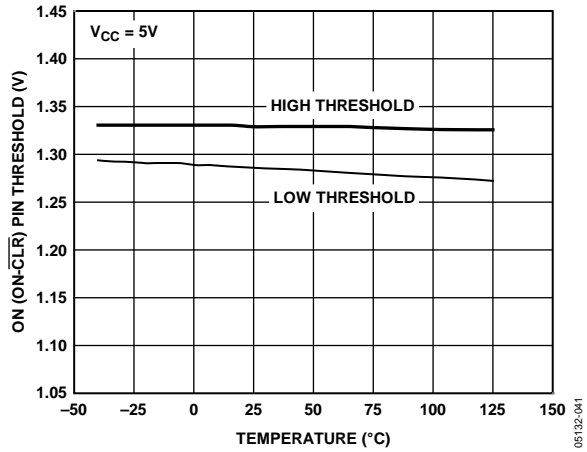

Figure 25. ON (ON-CLR) Pin Threshold vs. Temperature

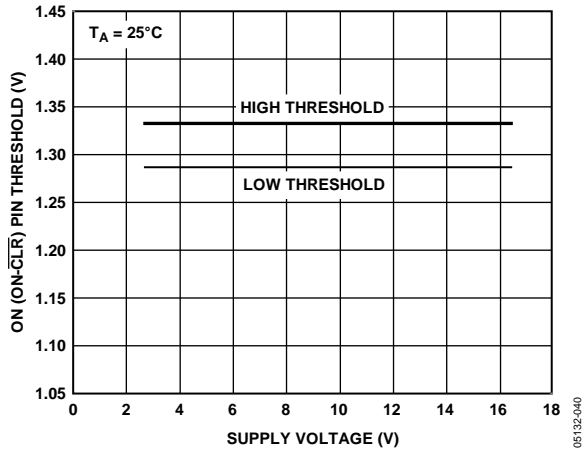

Figure 24. ON (ON-CLR) Pin Threshold vs. Supply Voltage

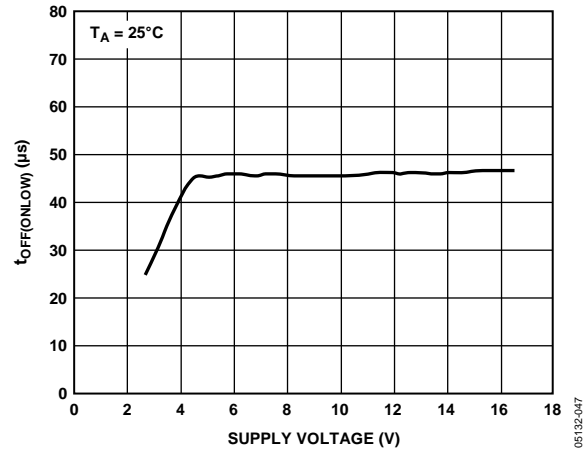

Figure 26. tOFF(ONLOW) vs. Supply Voltage

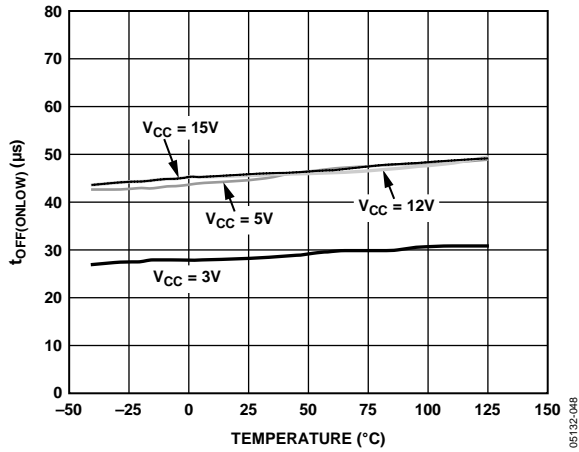

Figure 27. $t_{OFF(ONLOW)}$ vs. Temperature

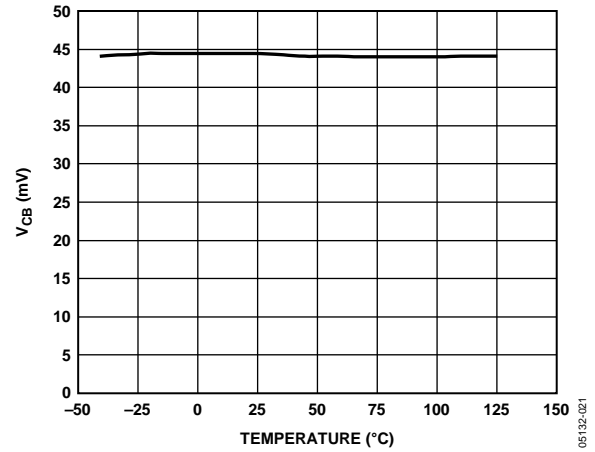

Figure 29. Cct Breaker Voltage vs. Temperature

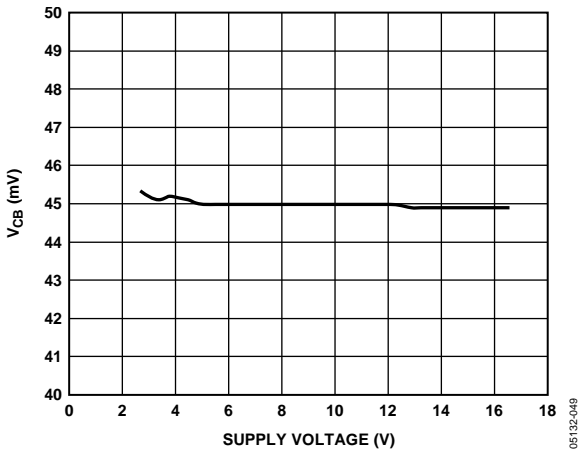

Figure 28. Cct Breaker Voltage vs. Supply Voltage

THEORY OF OPERATION

Many systems require the insertion or removal of circuit boards to live backplanes. During this event, the supply bypass and hold-up capacitors can require substantial transient currents from the backplane power supply as they charge. These currents can cause permanent damage to connector pins or undesirable glitches and resets to the system.

The ADM4210 is intended to control the powering of a system (on and off) in a controlled manner, allowing the board to be removed from, or inserted into, a live backplane by protecting it from excess currents. The ADM4210 can reside either on the backplane or on the removable board.

OVERVIEW

The ADM4210 operates over a supply range of 2.7 V to 16.5 V. As the supply voltage is coming up, an undervoltage lockout circuit checks if sufficient supply voltage is present for proper operation. During this period, the FET is held off by the GATE pin being held to GND. When the supply voltage reaches a level above UVLO and the ON (ON-CLR) pin is high, an initial timing cycle ensures that the board is fully inserted in the backplane before turning on the FET. The TIMER pin capacitor sets the periods for all of the TIMER pin functions. After the initial timing cycle, the ADM4210 monitors the inrush current through an external sense resistor. Overcurrent conditions are actively limited to $50 \text{ mV}/R_{\text{SENSE}}$ for the circuit breaker timer limit. The ADM4210-1 automatically retries after a current limit fault and the ADM4210-2 latches off. The retry duty cycle on the ADM4210-1 timer function is limited to 3.8% for FET cooling.

UVLO

If the V_{CC} supply is too low for normal operation, an undervoltage lockout circuit holds the ADM4210 in reset. The GATE pin is held to GND during this period. When the supply reaches this UVLO voltage, the ADM4210 starts when the ON (ON-CLR) pin condition is satisfied.

ON (ON-CLR) PIN

The ON (ON-CLR) pin is the enable pin. It is connected to a comparator that has a low-to-high threshold of 1.3 V with 80 mV hysteresis and a glitch filter. The ADM4210 is reset when the ON (ON-CLR) pin is low. When the ON (ON-CLR) pin is high, the ADM4210 is enabled. A rising edge on this pin has the added function of clearing a fault and restarting the device on the latched off model, the ADM4210-2. A low input on the ON (ON-CLR) pin turns off the external FET by pulling the GATE pin to ground and resets the timer. An external resistor divider at the ON (ON-CLR) pin can be used to program an undervoltage lockout value higher than the internal UVLO circuit. There is a glitch filter delay of approximately 3 μs on rising allowing the addition of an RC filter at the ON (ON-CLR) pin to increase the

delay time at card insertion. If using a short pin system to enable the device, a pull-down resistor should be used to hold the device prior to insertion.

GATE

Gate drive for the external N-channel MOSFET is achieved using an internal charge pump. The gate driver consists of a 12 μA pull-up from the internal charge pump. There are various pull-down devices on this pin. At a hot swap condition the board is hot inserted to the supply bus. During this event, it is possible for the external FET GATE capacitance to be charged up by the sudden presence of the supply voltage. This can cause uncontrolled inrush currents. An internal strong pull-down circuit holds GATE low while in UVLO. This reduces current surges at insertion. After the initial timing cycle, the GATE is then pulled high. During an overcurrent condition, the ADM4210 servos the GATE pin in an attempt to maintain a constant current to the load until the circuit breaker timeout completes. In the event of a timeout, the GATE pin abruptly shuts down using the 4 mA pull-down device. Care must be taken not to load the GATE pin resistively because this reduces the gate drive capability.

CURRENT LIMIT FUNCTION

The ADM4210 features a fast response current control loop that actively limits the current by reducing the gate voltage of the external FET. This current is measured by monitoring the voltage drop across an external sense resistor. The ADM4210 tries to regulate the gate of the FET to achieve a 50 mV voltage drop across the sense resistor.

CALCULATING THE CURRENT LIMIT

The sense resistor connected between V_{CC} and the SENSE pin is used to determine the nominal fault current limit. This is given by the following equation:

$$I_{\text{LIMIT}_{\text{NOM}}} = V_{\text{CB}_{\text{NOM}}}/R_{\text{SENSE}_{\text{NOM}}} \quad (1)$$

The minimum load current is given by Equation 2

$$I_{\text{LIMIT}_{\text{MIN}}} = V_{\text{CB}_{\text{MIN}}}/R_{\text{SENSE}_{\text{MAX}}} \quad (2)$$

The maximum load current is given by Equation 3

$$I_{\text{LIMIT}_{\text{MAX}}} = V_{\text{CB}_{\text{MAX}}}/R_{\text{SENSE}_{\text{MIN}}} \quad (3)$$

For proper operation, the minimum current limit must exceed the circuit maximum operating load current with margin. The sense resistor power rating must exceed

$$(V_{\text{CB}_{\text{MAX}}})^2/R_{\text{SENSE}_{\text{MIN}}}$$

CIRCUIT BREAKER FUNCTION

When the supply experiences a sudden current surge, such as a low impedance fault on load, the bus supply voltage can drop significantly to a point where the power to an adjacent card is affected, potentially causing system malfunctions. The ADM4210 limits the current drawn by the fault by reducing the gate voltage of the external FET. This minimizes the bus supply voltage drop caused by the fault and protects neighboring cards.

As the voltage across the sense resistor approaches the current limit, a timer activates. This timer resets again if the sense voltage returns below this level. If the sense voltage is any voltage below 44 mV, the timer is guaranteed to be off. Should the current continue to increase, the ADM4210 tries to regulate the gate of the FET to achieve a limit of 50 mV across the sense resistor. However, if the device is unable to regulate the fault current and the sense voltage further increases, a larger pull-down, in the order of milliamperes, is enabled to compensate for fast current surges. If the sense voltage is any voltage greater than 56 mV, this pull-down is guaranteed to be on. When the timer expires, the GATE pin shuts down.

TIMER FUNCTION

The TIMER pin is responsible for several key functions on the ADM4210. A capacitor controls the initial power on reset time and the amount of time an overcurrent condition lasts before the FET shuts down. On the ADM4210-1, the timer pin also controls the time between auto retry pulses. There are pull-up and pull-down currents internally available to control the timer functions. The voltage on the TIMER pin is compared with two threshold voltages: COMP1 (0.2 V) and COMP2 (1.3 V). The four timing currents are listed in Table 5.

Table 5.

Timing Current	Level (μA)
Pull-up	5
Pull-up	60
Pull-down	2
Pull-down	100

POWER-UP TIMING CYCLE

The ADM4210 is in reset when the ON (ON-CLR) pin is held low. The GATE pin is pulled low and the TIMER pin is pulled low with a 100 μA pull-down. At Time Point 2 in Figure 30, the ON (ON-CLR) pin is pulled high. For the device to startup correctly, the supply voltage must be above UVLO, the ON (ON-CLR) pin must be above 1.3 V, and the TIMER pin voltage must be less than 0.2 V. The initial timing cycle begins when these three conditions are met, and the TIMER pin is pulled high with 5 μA. At Time Point 3, the TIMER reaches the COMP2 threshold.

This is the end of the first section of the initial cycle. The 100 μA current source then pulls down the TIMER pin until it reaches 0.2 V at Time Point 4. The initial cycle delay (Time Point 2 to Time Point 4) relates to C_{TIMER} by equation

$$t_{INITIAL} = 1.3 \times C_{TIMER} / 5 \mu A \tag{4}$$

When the initial cycle ends, a start-up cycle activates and the GATE pin is pulled high; the TIMER pin continues to pull down.

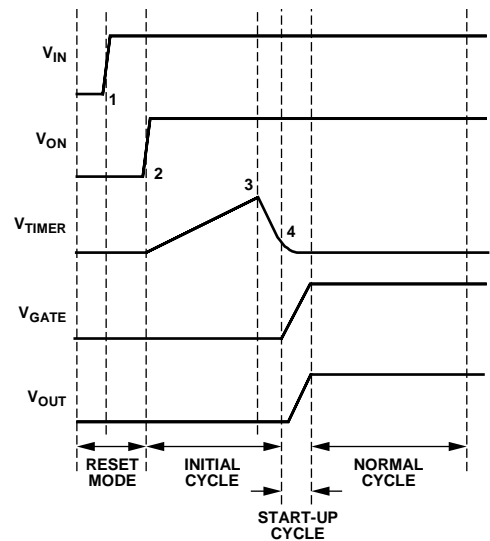

Figure 30. Power-Up Timing

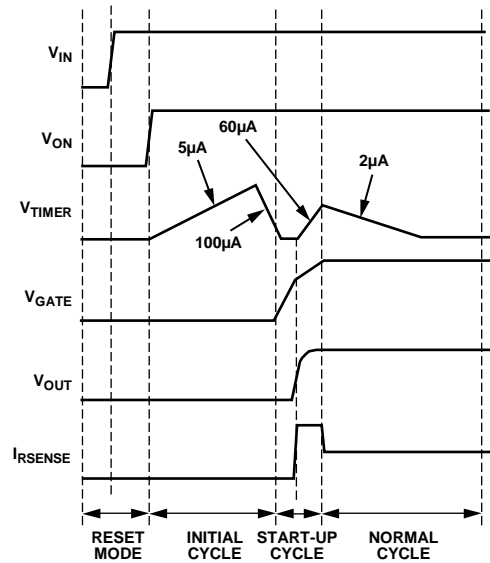

Figure 31. Power-Up into Capacitor

CIRCUIT BREAKER TIMING CYCLE

When the voltage across the sense resistor exceeds the circuit breaker trip voltage, the 60 μA timer pull-up current is activated. If the sense voltage falls below this level before the TIMER pin reaches 1.3 V, the 60 μA pull-up is disabled and the 2 μA pull-down is enabled. This is likely to happen if the overcurrent fault is only transient, such as an inrush current. This is shown in Figure 31. However, if the overcurrent condition is continuous and the sense voltage remains above the circuit breaker trip voltage, the 60 μA pull-up remains active. This allows the TIMER pin to reach the high trip point of 1.3 V and initiate the GATE shutdown. On the ADM4210-2, the TIMER pin continues pulling up but switches to the 5 μA pull-up when it reaches the 1.3 V threshold. The device can be reset by toggling the ON-CLR pin or by manually pulling the TIMER pin low. On the ADM4210-1, the TIMER pin activates the 2 μA pull-down once the 1.3 V threshold is reached, and continues to pull down until it reaches the 0.2 V threshold. At this point, the 100 μA pull-down is activated and the GATE pin is enabled. The device keeps retrying in the manner as shown in Figure 32.

The duty cycle of this automatic retry cycle is set to the ratio of 2 $\mu\text{A}/60 \mu\text{A}$, which approximates 3.8% on. The value of the timer capacitor determines the on time of this cycle. This time is calculated as follows:

$$t_{ON} = 1.3 \times C_{TIMER}/60 \mu\text{A}$$

$$t_{OFF} = 1.1 \times C_{TIMER}/2 \mu\text{A}$$

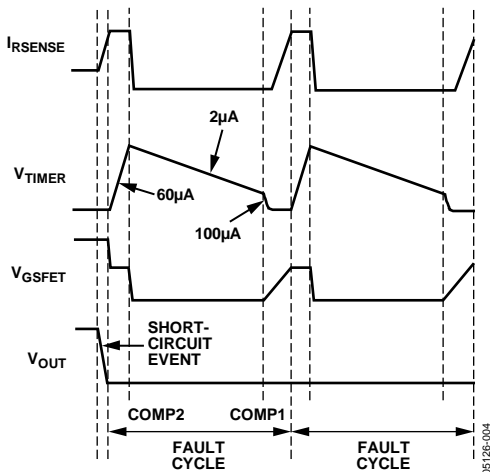

Figure 32. ADM4210-1 Automatic Retry During Overcurrent Fault

AUTOMATIC RETRY OR LATCHED OFF

The ADM4210 is available in two models. The ADM4210-1 has an automatic retry system whereby when a current fault is detected, the FET is shut down after a time determined by the timer capacitor, and it is switched on again in a controlled continuous cycle to determine if the fault remains (see Figure 32 for details). The period of this cycle is determined by the timer capacitor at a duty cycle of 3.8% on and 96.2% off.

The ADM4210-2 model has a latch off system whereby when a current fault is detected, the GATE is switched off after a time determined by the timer capacitor (see Figure 33 for details). Toggling the ON-CLR pin, or pulling the TIMER pin to GND for a brief period, resets this condition.

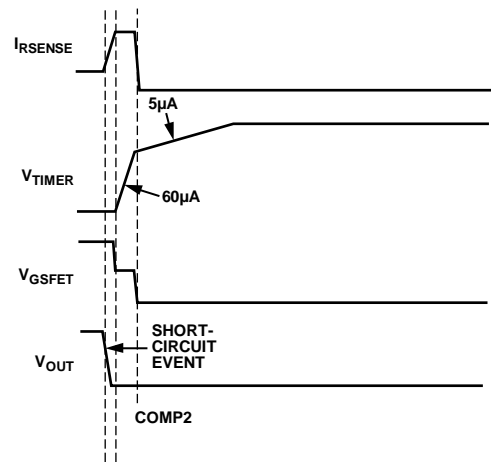
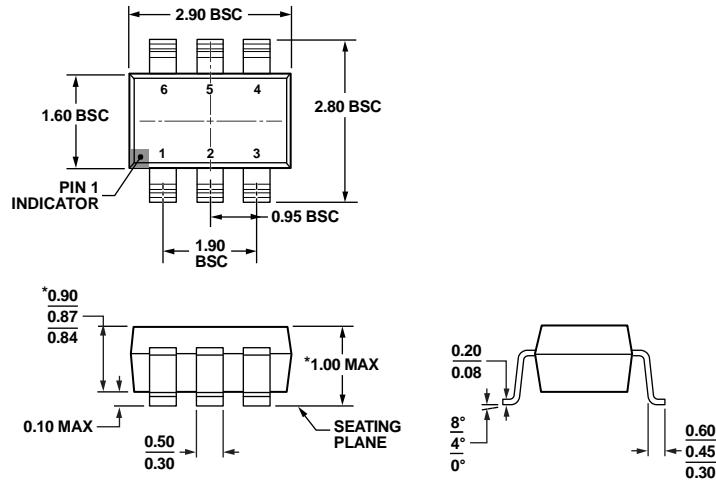

Figure 33. ADM4210-2 Latch Off After Overcurrent Fault

OUTLINE DIMENSIONS



*COMPLIANT TO JEDEC STANDARDS MO-193-AA WITH THE EXCEPTION OF PACKAGE HEIGHT AND THICKNESS.

Figure 34. 6-Lead Thin Small Outline Transistor Package [TSOT] (UJ-6)

Dimensions shown in millimeters

1028108-A

ORDERING GUIDE

Model ¹	Temperature Range	Package Description	Package Option	Branding
ADM4210-1AUJZ-RL7	-40°C to +85°C	6-Lead TSOT	UJ-6	M2P
ADM4210-2AUJZ-RL7	-40°C to +85°C	6-Lead TSOT	UJ-6	M2Q

¹ Z = RoHS Compliant Part.

NOTES

NOTES