

## FEATURES

### Stability in isolated feedback applications

0.5% initial accuracy

1% accuracy over the full temperature range

### Compatible with Type II or Type III compensation networks

Reference voltage: 1.225 V

### Compatible with DOSA

Low power operation: <7 mA total

### Wide voltage supply range

$V_{DD1}$ : 3 V to 20 V

$V_{DD2}$ : 3 V to 20 V

Bandwidth: 400 kHz

Isolation voltage: 2.5 kV rms

### Safety and regulatory approvals

UL recognition: 2500 V rms for 1 minute per UL 1577

CSA Component Acceptance Notice #5A

VDE certificate of conformity

DIN V VDE V 0884-10 (VDE V 0884-10):2006-12

$V_{IORM} = 565$  V peak

### Wide temperature range

-40°C to +125°C ambient operation

150°C maximum junction temperature

Qualified for automotive applications

## APPLICATIONS

Linear power supplies

Inverters

Uninterruptible Power Supply (UPS)

DOSA-compatible modules

Voltage monitors

Automotive systems

## GENERAL DESCRIPTION

The ADuM3190<sup>1</sup> is an isolated error amplifier based on Analog Devices, Inc., *iCoupler*<sup>®</sup> technology. The ADuM3190 is ideal for linear feedback power supplies. The primary side controllers of the ADuM3190 enable improvements in transient response, power density, and stability as compared to commonly used optocoupler and shunt regulator solutions.

Unlike optocoupler-based solutions, which have an uncertain current transfer ratio over lifetime and at high temperatures, the ADuM3190 transfer function does not change over its lifetime, and it is stable over a wide temperature range of -40°C to +125°C.

Included in the ADuM3190 is a wideband operational amplifier for a variety of commonly used power supply loop compensation techniques. The ADuM3190 is fast enough to allow a feedback loop to react to fast transient conditions and overcurrent conditions. Also included is a high accuracy 1.225 V reference to compare with the supply output setpoint.

The ADuM3190 is packaged in a small 16-lead QSOP package for a 2.5 kV rms isolation voltage rating.

## FUNCTIONAL BLOCK DIAGRAM

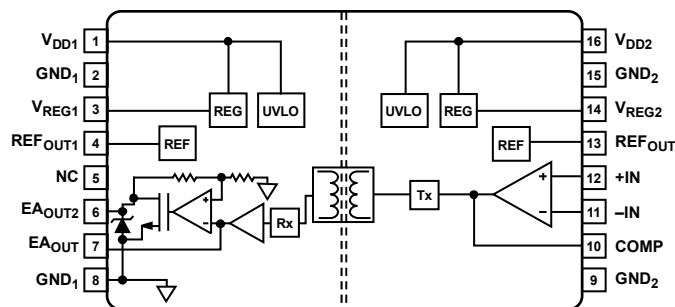

Figure 1.

<sup>1</sup> Protected by U.S. Patents 5,952,849, 6,873,065 and 7,075,329. Other patents pending.

### Rev. A

### Document Feedback

Information furnished by Analog Devices is believed to be accurate and reliable. However, no responsibility is assumed by Analog Devices for its use, nor for any infringements of patents or other rights of third parties that may result from its use. Specifications subject to change without notice. No license is granted by implication or otherwise under any patent or patent rights of Analog Devices. Trademarks and registered trademarks are the property of their respective owners.

## TABLE OF CONTENTS

Features .....	1	Typical Performance Characteristics .....	9
Applications.....	1	Test Circuits.....	13
General Description .....	1	Applications Information .....	14
Functional Block Diagram .....	1	Theory of Operation .....	14
Revision History .....	2	Accuracy Circuit Operation.....	14
Specifications.....	3	Isolated Amplifier Circuit Operation .....	14
Package Characteristics .....	5	Application Block Diagram .....	15
Regulatory Information.....	5	Setting the Output Voltage.....	15
Insulation and Safety Related Specifications .....	5	DOSA Module Application.....	15
Recommended Operating Conditions .....	5	DC Correctness and Magnetic Field Immunity .....	16
DIN V VDE V 0884-10 (VDE V 0884-10) Insulation		Insulation Lifetime .....	17
Characteristics .....	6	Packaging and Ordering Information .....	18
Absolute Maximum Ratings .....	7	Outline Dimensions.....	18
ESD Caution.....	7	Ordering Guide .....	18
Pin Configuration and Function Descriptions.....	8	Automotive Products.....	18

## REVISION HISTORY

### 7/15—Rev. 0 to Rev. A

Added W Models.....	Universal
Changes to Features Section and Applications Section.....	1
Changes to Table 1.....	3
Changes to Regulatory Information Section and Table 3 .....	5
Changes to DIN V VDE V 0884-10 (VDE V 0884-10)	
Insulation Characteristics Section and Table 6.....	6
Change to AC Voltage, Bipolar Parameter, Table 8.....	7
Changes to Figure 12 and Figure 14.....	10
Added Figure 16 to Figure 24; Renumbered Sequentially .....	11
Deleted Figure 24; Renumbered Sequentially .....	13
Added Isolated Amplifier Circuit Operation Section.....	14
Changes to Applications Block Diagram Section.....	15
Updated Outline Dimensions .....	18
Changes to Ordering Guide .....	18
Added Automotive Products Section.....	18

### 2/13—Revision 0: Initial Version

## SPECIFICATIONS

$V_{DD1} = V_{DD2} = 3\text{ V to }20\text{ V}$  for  $T_A = T_{MIN}$  to  $T_{MAX}$ . All typical specifications are at  $T_A = 25^\circ\text{C}$  and  $V_{DD1} = V_{DD2} = 5\text{ V}$ , unless otherwise noted.

Table 1.

Parameter	Test Conditions/Comments	Min	Typ	Max	Unit
ACCURACY	$(1.225\text{ V} - EA_{OUT})/1.225\text{ V} \times 100\%$ ; see Figure 27				
Initial Error	$T_A = 25^\circ\text{C}$		0.25	0.5	%
Total Error	$T_A = T_{MIN}$ to $T_{MAX}$		0.5	1	%
OP AMP					
Offset Error		-5	$\pm 2.5$	+5	mV
Open-Loop Gain		66	80		dB
Input Common-Mode Range		0.35		1.5	V
Gain Bandwidth Product			10		MHz
Common-Mode Rejection			72		dB
Input Capacitance			2		pF
Output Voltage Range	COMP pin	0.2		2.7	V
Input Bias Current			0.01		$\mu\text{A}$
REFERENCE					
Output Voltage	0 mA to 1 mA load, $C_{REFOUT} = 15\text{ pF}$ $T_A = 25^\circ\text{C}$ $T_A = T_{MIN}$ to $T_{MAX}$	1.215 1.213	1.225 1.225	1.235 1.237	V V
Output Current	$C_{REFOUT} = 15\text{ pF}$	2.0			mA
UVLO					
Positive Going Threshold			2.8	2.96	V
Negative Going Threshold		2.4	2.6		V
$EA_{OUT}$ Impedance	$V_{DD2}$ or $V_{DD1} < \text{UVLO threshold}$		High-Z		$\Omega$
OUTPUT CHARACTERISTICS	See Figure 29				
Output Gain <sup>1</sup>					
A, B, S, and T Grades	From COMP to $EA_{OUT}$ , 0.4 V to 2.1 V, $\pm 3\text{ mA}$ From $EA_{OUT}$ to $EA_{OUT2}$ , 0.4 V to 2.1 V, $\pm 1\text{ mA}$ , $V_{DD1} = 20\text{ V}$	0.9 2.34	1.0 2.6	1.1 2.86	V/V V/V
WS and WT Grades	From COMP to $EA_{OUT}$ , 0.4 V to 2.1 V, $\pm 3\text{ mA}$ From $EA_{OUT}$ to $EA_{OUT2}$ , 0.4 V to 2.1 V, $\pm 1\text{ mA}$ , $V_{DD1} = 20\text{ V}$	0.83 2.5	1.0 2.6	1.17 2.7	V/V V/V
Output Offset Voltage	From COMP to $EA_{OUT}$ , 0.4 V to 2.1 V, $\pm 3\text{ mA}$ From $EA_{OUT}$ to $EA_{OUT2}$ , 0.4 V to 2.1 V, $\pm 1\text{ mA}$ , $V_{DD1} = 20\text{ V}$	-0.2 -0.1	+0.05 +0.01	+0.2 +0.1	V V
Output Linearity <sup>2</sup>	From COMP to $EA_{OUT}$ , 0.4 V to 2.1 V, $\pm 3\text{ mA}$ From $EA_{OUT}$ to $EA_{OUT2}$ , 0.4 V to 2.1 V, $\pm 1\text{ mA}$ , $V_{DD1} = 20\text{ V}$	-1.0 -1.0	+0.15 +0.1	+1.0 +1.0	% %
Output -3 dB Bandwidth	From COMP to $EA_{OUT}$ , 0.4 V to 2.1 V, $\pm 3\text{ mA}$ , and from COMP to $EA_{OUT2}$ , 0.4 V to 2.1 V, $\pm 1\text{ mA}$ , $V_{DD1} = 20\text{ V}$				
A, S, and WS Grades		100	200		kHz
B, T, and WT Grades		250	400		kHz
Output Voltage, $EA_{OUT}$	$\pm 3\text{ mA}$ output				
Low Voltage				0.4	V
High Voltage		2.4	2.7		V
Output Voltage, $EA_{OUT2}$	$\pm 1\text{ mA}$ output				
Low Voltage	$V_{DD1} = 4.5\text{ V to }5.5\text{ V}$ $V_{DD1} = 10\text{ V to }20\text{ V}$		0.3 0.3	0.6 0.6	V V
High Voltage	$V_{DD1} = 4.5\text{ V to }5.5\text{ V}$ $V_{DD1} = 10\text{ V to }20\text{ V}$	4.8 5.0	4.9 5.4		V V
Noise, $EA_{OUT}$	See Figure 15		1.7		mV rms
Noise, $EA_{OUT2}$	See Figure 15		4.8		mV rms

Parameter	Test Conditions/Comments	Min	Typ	Max	Unit
POWER SUPPLY					
Operating Range, Side 1	$V_{DD1}$	3.0		20	V
Operating Range, Side 2	$V_{DD2}$	3.0		20	V
Power Supply Rejection	DC, $V_{DD1} = V_{DD2} = 3\text{ V to }20\text{ V}$	60			dB
Supply Current					
$I_{DD1}$	See Figure 4		1.4	2.0	mA
$I_{DD2}$	See Figure 5		2.9	5.0	mA

<sup>1</sup> Output gain is defined as the slope of the best-fit line of the output voltage vs. the input voltage over the specified input range, with the offset error adjusted out.

<sup>2</sup> Output linearity is defined as the peak-to-peak output deviation from the best-fit line of the output gain, expressed as a percentage of the full-scale output voltage.

## PACKAGE CHARACTERISTICS

Table 2.

Parameter	Symbol	Min	Typ	Max	Unit	Test Conditions/Comments
RESISTANCE Input-to-Output <sup>1</sup>	R <sub>I-O</sub>		10 <sup>13</sup>		Ω	
CAPACITANCE Input-to-Output <sup>1</sup>	C <sub>I-O</sub>		2.2		pF	f = 1 MHz
Input Capacitance <sup>2</sup>	C <sub>I</sub>		4.0		pF	
IC JUNCTION-TO-AMBIENT THERMAL RESISTANCE 16-Lead QSOP	θ <sub>JA</sub>		76		°C/W	Thermocouple located at center of package underside

<sup>1</sup> The device is considered a 2-terminal device; Pin 1 through Pin 8 are shorted together, and Pin 9 through Pin 16 are shorted together.

<sup>2</sup> Input capacitance is from any input data pin to ground.

## REGULATORY INFORMATION

The ADuM3190 is approved by the organizations listed in Table 3. See Table 8 and the Insulation Lifetime section for recommended maximum working voltages for specific cross-isolation waveforms and insulation levels.

Table 3.

UL	CSA	VDE
Recognized Under 1577 Component Recognition Program <sup>1</sup> Single Protection, 2500 V rms Isolation Voltage, 16-Lead QSOP  File E214400	Approved under CSA Component Acceptance Notice #5A Basic insulation per CSA 60950-1-03 and IEC 60950-1, 400 V rms (565 V peak) maximum working voltage  File 205078	Certified according to DIN V VDE V 0884-10 (VDE V 0884-10): 2006-12 <sup>2</sup> Reinforced insulation, 565 V peak  File 2471900-4880-0001

<sup>1</sup> In accordance with UL 1577, each ADuM3190 is proof tested by applying an insulation test voltage ≥ 3000 V rms for 1 sec (current leakage detection limit = 5 μA).

<sup>2</sup> In accordance with DIN V VDE V 0884-10, each ADuM3190 is proof tested by applying an insulation test voltage ≥ 1050 V peak for 1 sec (partial discharge detection limit = 5 pC). The asterisk (\*) marked on the component designates DIN V VDE V 0884-10 approval.

## INSULATION AND SAFETY RELATED SPECIFICATIONS

Table 4.

Parameter	Symbol	Value	Unit	Test Conditions/Comments
Rated Dielectric Insulation Voltage		2500	V rms	1-minute duration
Minimum External Air Gap (Clearance)	L(I01)	3.8 min	mm	Measured from input terminals to output terminals, shortest distance through air
Minimum External Tracking (Creepage)	L(I02)	3.1 min	mm	Measured from input terminals to output terminals, shortest distance path along body
Minimum Internal Gap (Internal Clearance)		0.017 min	mm	Insulation distance through insulation
Tracking Resistance (Comparative Tracking Index)	CTI	>400	V	DIN IEC 112/VDE 0303, Part 1
Isolation Group		II		Material Group DIN VDE 0110, 1/89, Table 1

## RECOMMENDED OPERATING CONDITIONS

Table 5.

Parameter	Symbol	Min	Max	Unit
OPERATING TEMPERATURE BY MODEL ADuM3190A/ADuM3190B ADuM3190S/ADuM3190T	T <sub>A</sub>	-40	+85	°C
		-40	+125	°C
SUPPLY VOLTAGES <sup>1</sup>	V <sub>DD1</sub> , V <sub>DD2</sub>	3.0	20	V
INPUT SIGNAL RISE AND FALL TIMES	t <sub>R</sub> , t <sub>F</sub>		1.0	ms

<sup>1</sup> All voltages are relative to their respective grounds.

**DIN V VDE V 0884-10 (VDE V 0884-10) INSULATION CHARACTERISTICS**

These isolators are suitable for reinforced isolation only within the safety limit data. Maintenance of the safety data is ensured by protective circuits. The asterisk (\*) marking branded on the package denotes DIN V VDE V 0884-10 approval for a 565 V peak working voltage.

Table 6.

Description	Test Conditions/Comments	Symbol	Characteristic	Unit
Installation Classification per DIN VDE 0110 For Rated Mains Voltage ≤ 150 V rms For Rated Mains Voltage ≤ 300 V rms For Rated Mains Voltage ≤ 400 V rms			I to IV I to III I to II	
Climatic Classification			40/105/21	
Pollution Degree per DIN VDE 0110, Table 1			2	
Maximum Working Insulation Voltage		$V_{IORM}$	565	V peak
Input-to-Output Test Voltage, Method B1	$V_{IORM} \times 1.875 = V_{pd(m)}$ , 100% production test, $t_{ini} = t_m = 1$ sec, partial discharge < 5 pC	$V_{pd(m)}$	1059	V peak
Input-to-Output Test Voltage, Method A After Environmental Tests Subgroup 1	$V_{IORM} \times 1.5 = V_{pd(m)}$ , $t_{ini} = 60$ sec, $t_m = 10$ sec, partial discharge < 5 pC	$V_{pd(m)}$	848	V peak
After Input and/or Safety Test Subgroup 2 and Subgroup 3	$V_{IORM} \times 1.2 = V_{pd(m)}$ , $t_{ini} = 60$ sec, $t_m = 10$ sec, partial discharge < 5 pC	$V_{pd(m)}$	678	V peak
Highest Allowable Overvoltage		$V_{IOTM}$	4000	V peak
Surge Isolation Voltage		$V_{IOSM}$	6250	V peak
Safety Limiting Values	$V_{PEAK} = 10$ kV; 1.2 μs rise time; 50 μs, 50% fall time Maximum value allowed in the event of a failure (see Figure 2)			
Case Temperature		$T_S$	150	°C
Safety Total Dissipated Power		$P_S$	1.64	W
Insulation Resistance at $T_S$	$V_{IO} = 500$ V	$R_S$	>10 <sup>9</sup>	Ω

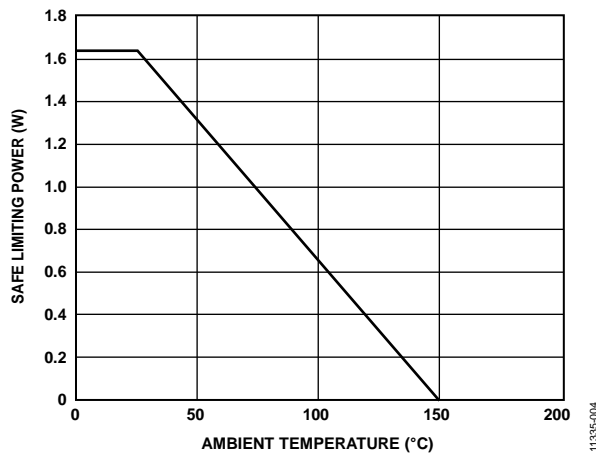

Figure 2. Thermal Derating Curve, Dependence of Safety Limiting Values on Case Temperature, per DIN V VDE V 0884-10

**ABSOLUTE MAXIMUM RATINGS**

$T_A = 25^\circ\text{C}$ , unless otherwise noted.

**Table 7.**

Parameter	Rating
Storage Temperature ( $T_{ST}$ ) Range	$-65^\circ\text{C}$ to $+150^\circ\text{C}$
Ambient Operating Temperature ( $T_A$ ) Range	$-40^\circ\text{C}$ to $+125^\circ\text{C}$
Junction Temperature	$-40^\circ\text{C}$ to $+150^\circ\text{C}$
Supply Voltages	
$V_{DD1}$ , $V_{DD2}$ <sup>1</sup>	$-0.5\text{ V}$ to $+24\text{ V}$
$V_{REG1}$ , $V_{REG2}$ <sup>1</sup>	$-0.5\text{ V}$ to $+3.6\text{ V}$
Input Voltages (+IN, -IN)	$-0.5\text{ V}$ to $+3.6\text{ V}$
Output Voltages	
$REF_{OUT}$ , COMP, $REF_{OUT1}$ , $EA_{OUT}$	$-0.5\text{ V}$ to $+3.6\text{ V}$
$EA_{OUT2}$	$-0.5\text{ V}$ to $+5.5\text{ V}$
Output Current per Output Pin	$-11\text{ mA}$ to $+11\text{ mA}$
Common-Mode Transients <sup>2</sup>	$-100\text{ kV}/\mu\text{s}$ to $+100\text{ kV}/\mu\text{s}$

<sup>1</sup> All voltages are relative to their respective grounds.

<sup>2</sup> Refers to common-mode transients across the insulation barrier. Common-mode transients exceeding the absolute maximum ratings may cause latch-up or permanent damage.

Stresses at or above those listed under Absolute Maximum Ratings may cause permanent damage to the product. This is a stress rating only; functional operation of the product at these or any other conditions above those indicated in the operational section of this specification is not implied. Operation beyond the maximum operating conditions for extended periods may affect product reliability.

**Table 8. Maximum Continuous Working Voltage<sup>1</sup>**

Parameter	Max	Unit	Constraint
WAVEFORM			
AC Voltage			
Bipolar	565	V peak	50-year minimum lifetime
Unipolar	1131	V peak	50-year minimum lifetime
DC Voltage	1131	V peak	50-year minimum lifetime

<sup>1</sup> Refers to continuous voltage magnitude imposed across the isolation barrier. See the Insulation Lifetime section for more details.

**ESD CAUTION**

**ESD (electrostatic discharge) sensitive device.** Charged devices and circuit boards can discharge without detection. Although this product features patented or proprietary protection circuitry, damage may occur on devices subjected to high energy ESD. Therefore, proper ESD precautions should be taken to avoid performance degradation or loss of functionality.

## PIN CONFIGURATION AND FUNCTION DESCRIPTIONS

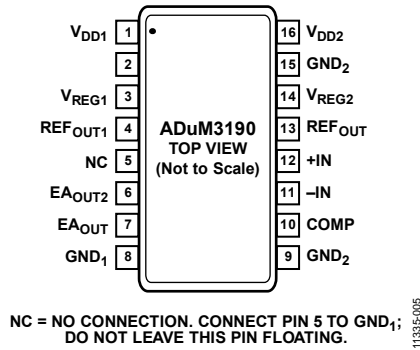

Figure 3. Pin Configuration

Table 9. Pin Function Descriptions

Pin No.	Mnemonic	Description
1	V <sub>DD1</sub>	Supply Voltage for Side 1 (3.0 V to 20 V). Connect a 1 $\mu$ F capacitor between V <sub>DD1</sub> and GND <sub>1</sub> .
2	GND <sub>1</sub>	Ground Reference for Side 1.
3	V <sub>REG1</sub>	Internal Supply Voltage for Side 1. Connect a 1 $\mu$ F capacitor between V <sub>REG1</sub> and GND <sub>1</sub> .
4	REF <sub>OUT1</sub>	Reference Output Voltage for Side 1. The maximum capacitance for this pin (C <sub>REFOUT1</sub> ) must not exceed 15 pF.
5	NC	No Connection. Connect Pin 5 to GND <sub>1</sub> ; do not leave this pin floating.
6	EA <sub>OUT2</sub>	Isolated Output Voltage 2, Open-Drain Output. Connect a pull-up resistor between EA <sub>OUT2</sub> and V <sub>DD1</sub> for current up to 1 mA.
7	EA <sub>OUT</sub>	Isolated Output Voltage.
8	GND <sub>1</sub>	Ground Reference for Side 1.
9	GND <sub>2</sub>	Ground Reference for Side 2.
10	COMP	Output of the Op Amp. A loop compensation network can be connected between the COMP pin and the -IN pin.
11	-IN	Inverting Op Amp Input. Pin 11 is the connection for the power supply setpoint and compensation network.
12	+IN	Noninverting Op Amp Input. Pin 12 can be used as a reference input.
13	REF <sub>OUT</sub>	Reference Output Voltage for Side 2. The maximum capacitance for this pin (C <sub>REFOUT</sub> ) must not exceed 15 pF.
14	V <sub>REG2</sub>	Internal Supply Voltage for Side 2. Connect a 1 $\mu$ F capacitor between V <sub>REG2</sub> and GND <sub>2</sub> .
15	GND <sub>2</sub>	Ground Reference for Side 2.
16	V <sub>DD2</sub>	Supply Voltage for Side 2 (3.0 V to 20 V). Connect a 1 $\mu$ F capacitor between V <sub>DD2</sub> and GND <sub>2</sub> .



### TYPICAL PERFORMANCE CHARACTERISTICS

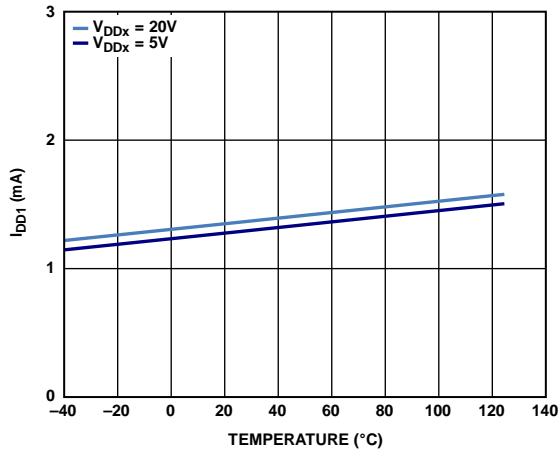

Figure 4. Typical I<sub>DD1</sub> Supply Current vs. Temperature

11335-017

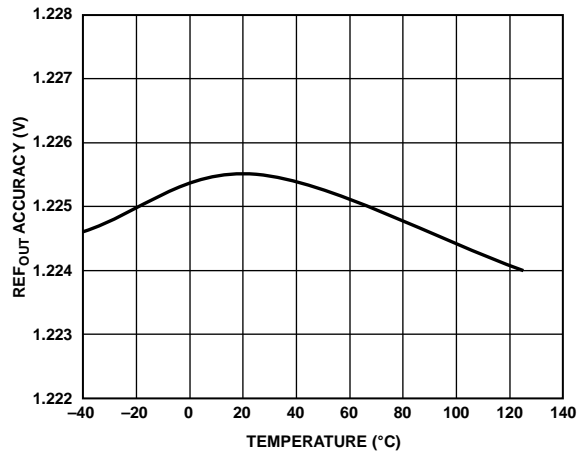

Figure 7. REF<sub>OUT</sub> Accuracy vs. Temperature

11335-020

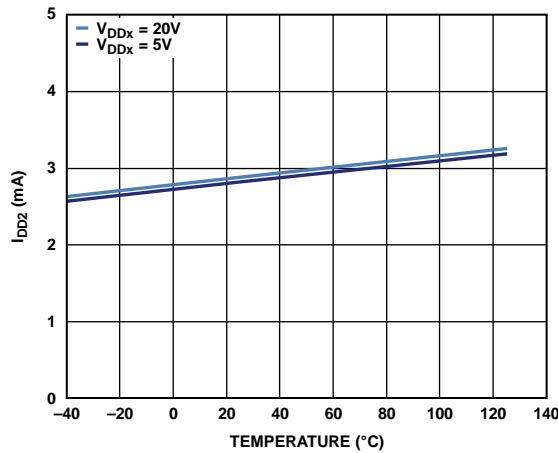

Figure 5. Typical I<sub>DD2</sub> Supply Current vs. Temperature

11335-018

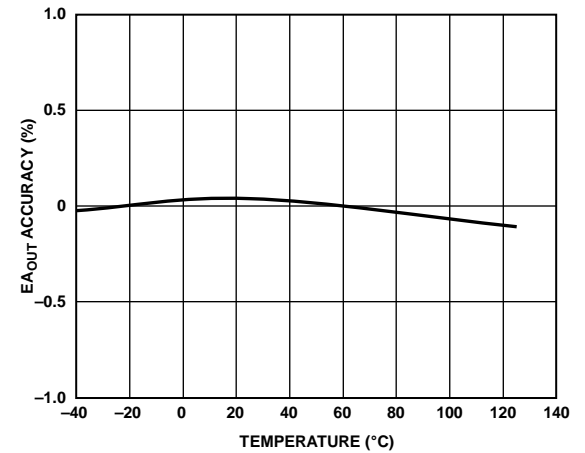

Figure 8. EA<sub>OUT</sub> Accuracy vs. Temperature

11335-021

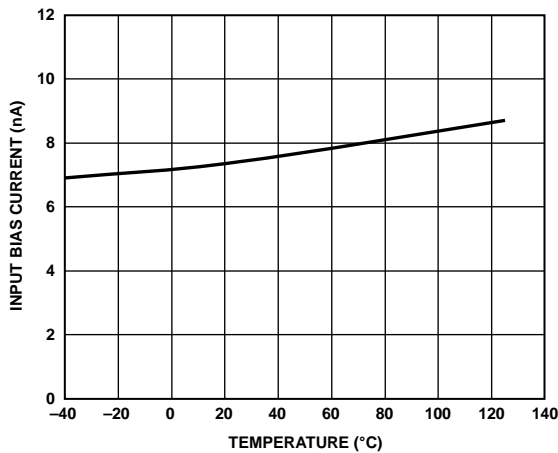

Figure 6. +IN, -IN Input Bias Current vs. Temperature

11335-019

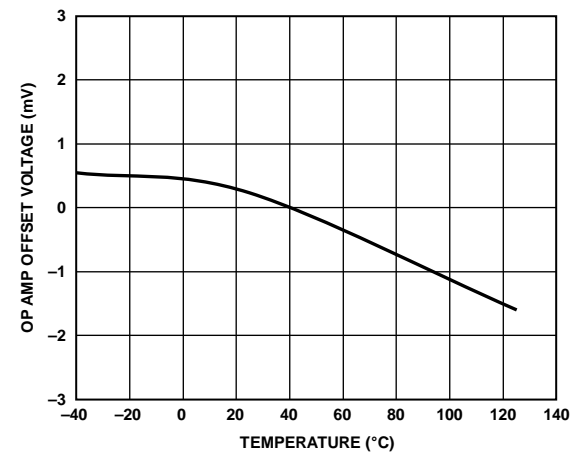

Figure 9. Op Amp Offset Voltage vs. Temperature

11335-022

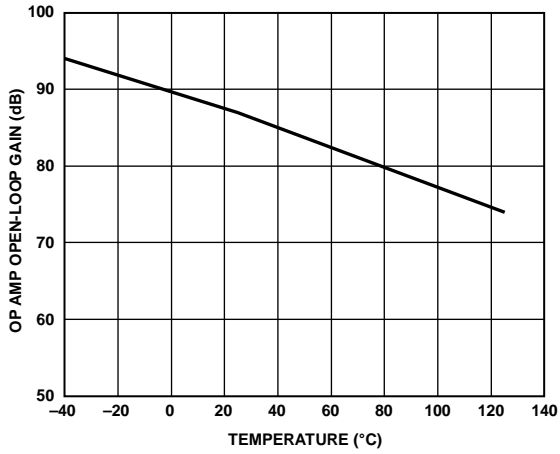

Figure 10. Op Amp Open-Loop Gain vs. Temperature

11335-023

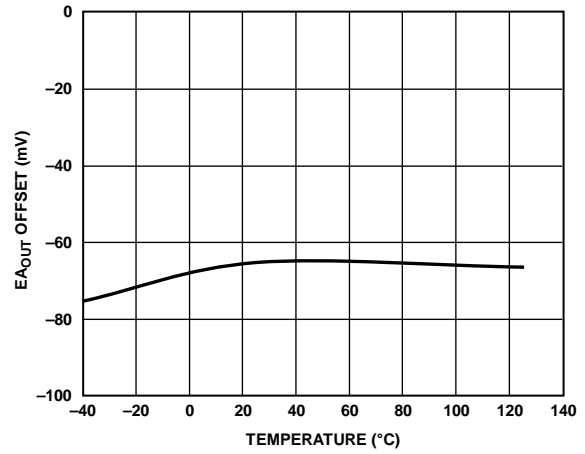

Figure 13. EAOUT Offset Voltage vs. Temperature

11335-026

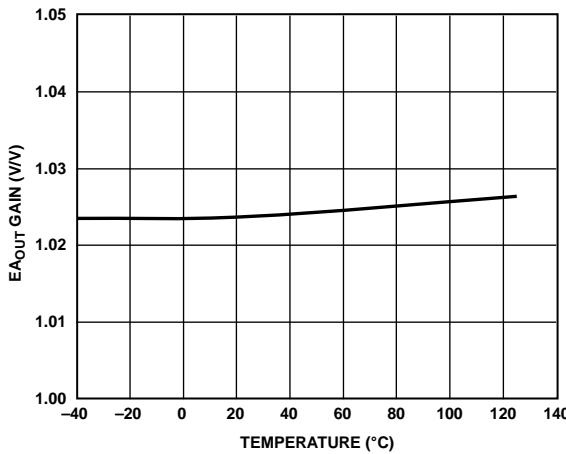

Figure 11. EAOUT Gain vs. Temperature

11335-024

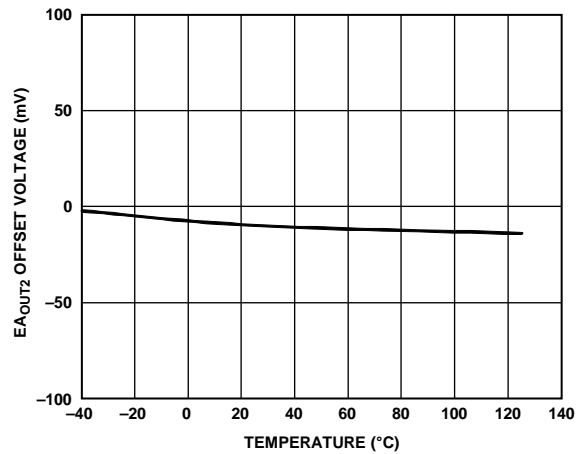

Figure 14. EAOUT2 Offset Voltage vs. Temperature

11335-027

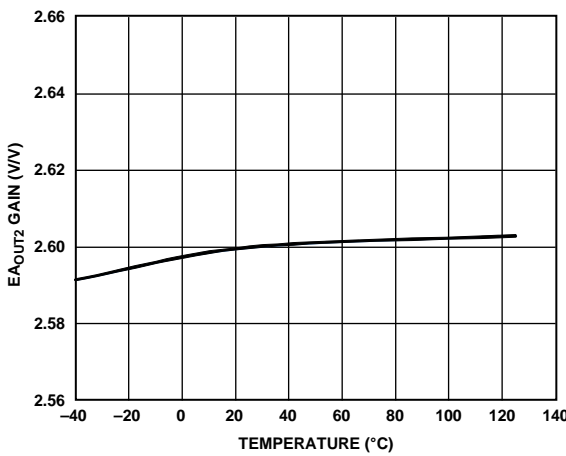

Figure 12. EAOUT2 Gain vs. Temperature

11335-025

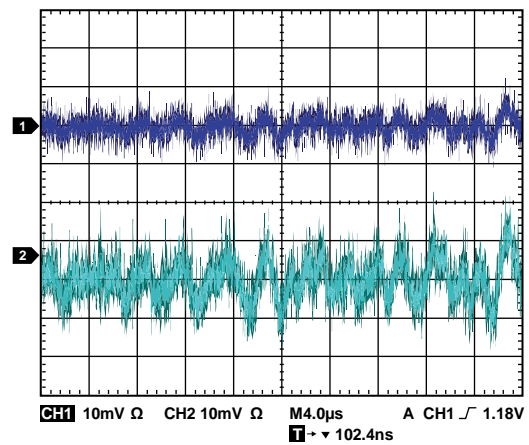

Figure 15. Output Noise with Test Circuit 1 (10 mV/DIV), Channel 1 = EAOUT, Channel 2 = EAOUT2

11335-028

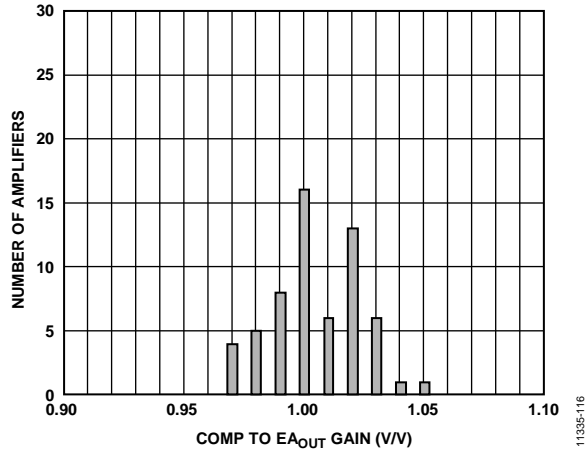

Figure 16. EA<sub>OUT</sub> Gain Distribution at 25°C

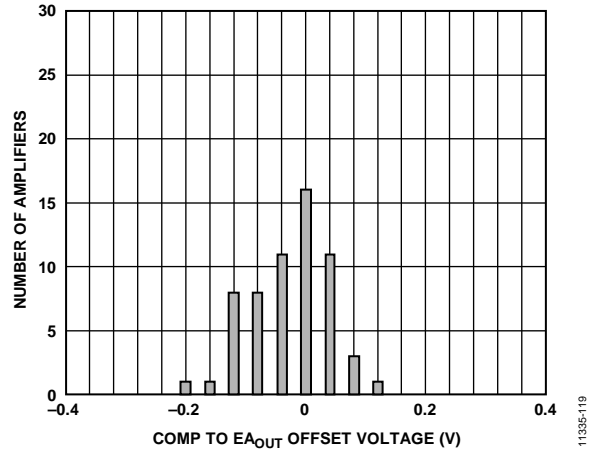

Figure 19. EA<sub>OUT</sub> Offset Voltage Distribution at 25°C

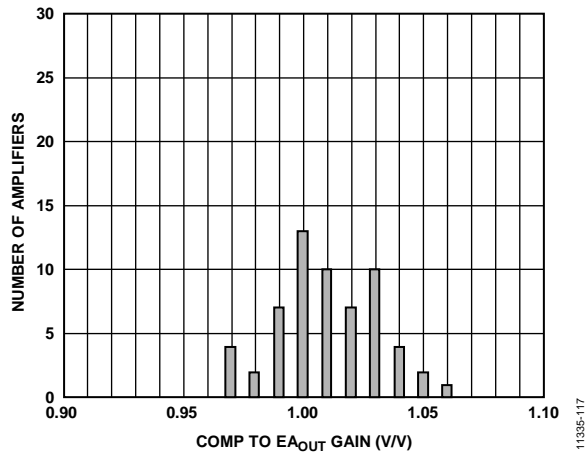

Figure 17. EA<sub>OUT</sub> Gain Distribution at 125°C

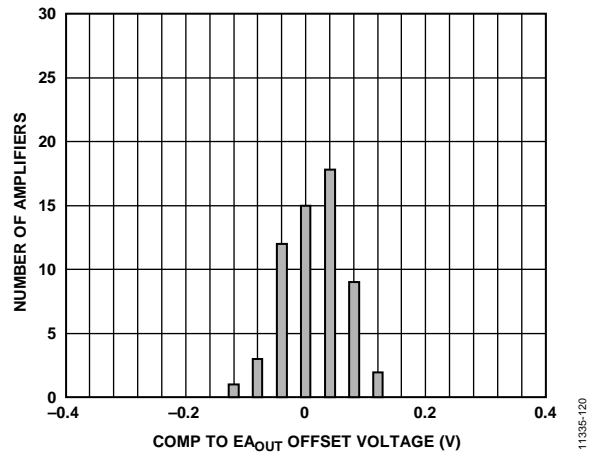

Figure 20. EA<sub>OUT</sub> Offset Voltage Distribution at 125°C

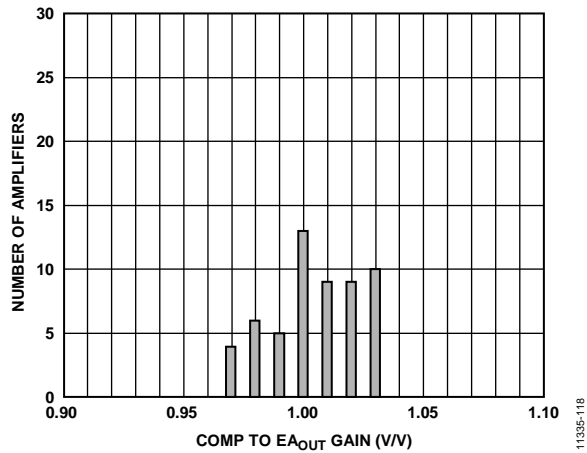

Figure 18. EA<sub>OUT</sub> Gain Distribution at -40°C

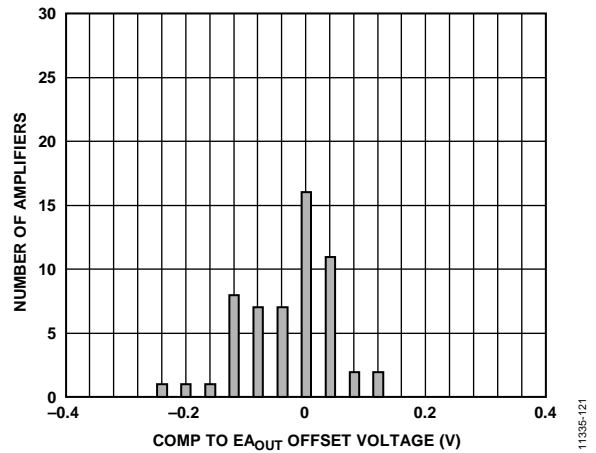

Figure 21. EA<sub>OUT</sub> Offset Voltage Distribution at -40°C

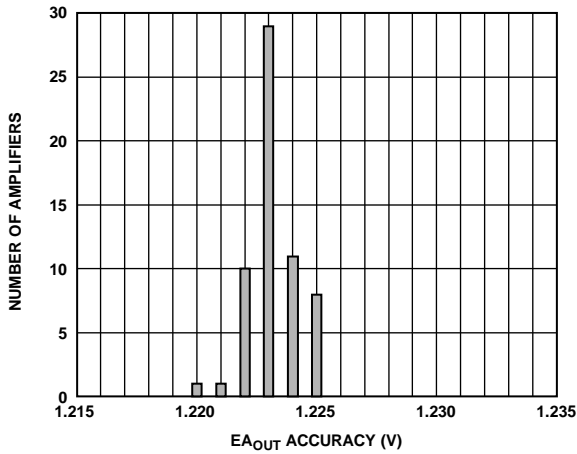

Figure 22. EA<sub>OUT</sub> Accuracy Voltage Distribution at 25°C

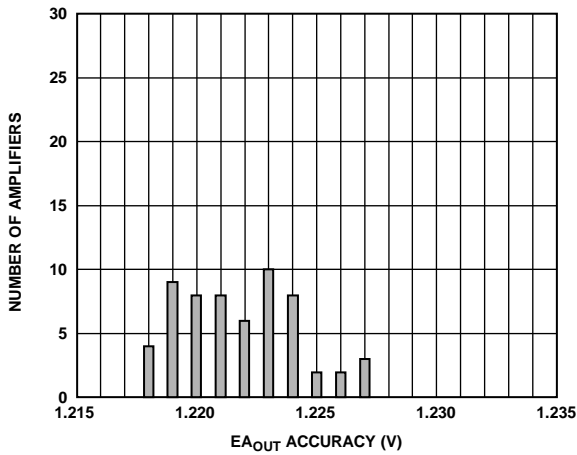

Figure 23. EA<sub>OUT</sub> Accuracy Voltage Distribution at 125°C

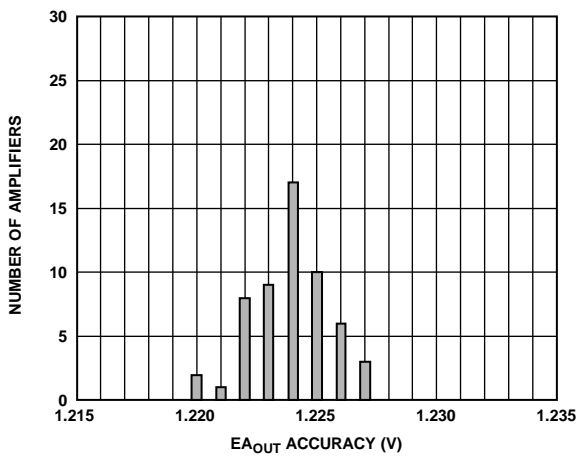

Figure 24. EA<sub>OUT</sub> Accuracy Voltage Distribution at -40°C

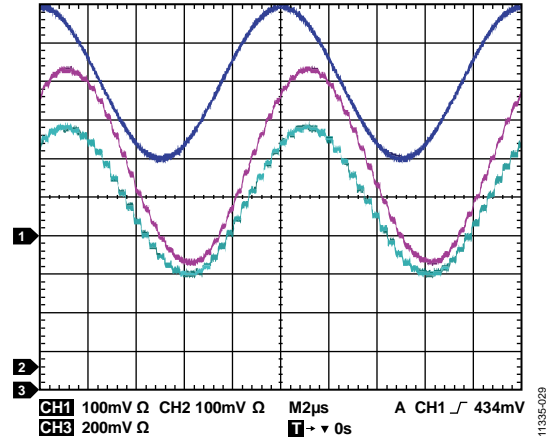

Figure 25. Output 100 kHz Signal with Test Circuit 3, Channel 1 = +IN, Channel 2 = EA<sub>OUT</sub>, Channel 3 = EA<sub>OUT2</sub>

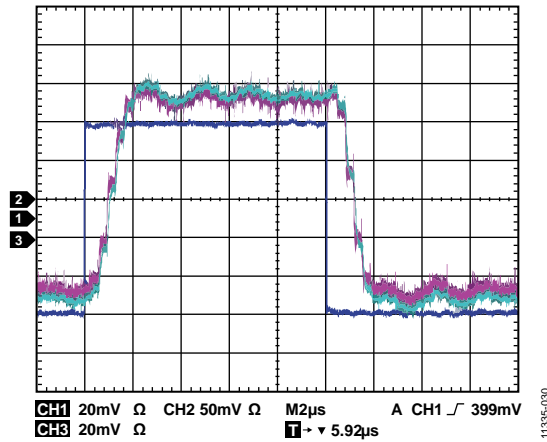

Figure 26. Output Square Wave Response with Test Circuit 3, Channel 1 = +IN, Channel 2 = EA<sub>OUT</sub>, Channel 3 = EA<sub>OUT2</sub>



## APPLICATIONS INFORMATION

### THEORY OF OPERATION

In the test circuits of the ADuM3190 (see Figure 27 through Figure 29), external supply voltages from 3 V to 20 V are provided to the  $V_{DD1}$  and  $V_{DD2}$  pins, and internal regulators provide 3.0 V to operate the internal circuits of each side of the ADuM3190. An internal precision 1.225 V reference provides the reference for the  $\pm 1\%$  accuracy of the isolated error amplifier. UVLO circuits monitor the  $V_{DDx}$  supplies to turn on the internal circuits when the 2.8 V rising threshold is met and to turn off the error amplifier outputs to a high impedance state when  $V_{DDx}$  falls below 2.6 V.

The op amp on the right side of the device has a noninverting +IN pin and an inverting -IN pin available for connecting a feedback voltage in an isolated dc-to-dc converter output, usually through a voltage divider. The COMP pin is the op amp output, which can be used to attach resistor and capacitor components in a compensation network. The COMP pin internally drives the Tx transmitter block, which converts the op amp output voltage into an encoded output that is used to drive the digital isolator transformer.

On the left side of the ADuM3190, the transformer output PWM signal is decoded by the Rx block, which converts the signal into a voltage that drives an amplifier block; the amplifier block produces the error amplifier output available at the EA<sub>OUT</sub> pin. The EA<sub>OUT</sub> pin can deliver  $\pm 3$  mA and has a voltage level between 0.4 V and 2.4 V, which is typically used to drive the input of a PWM controller in a dc-to-dc circuit.

For applications that need more output voltage to drive their controllers, Figure 28 illustrates the use of the EA<sub>OUT2</sub> pin output, which delivers up to  $\pm 1$  mA with an output voltage of 0.6 V to 4.8 V for an output that has a pull-up resistor to a 5 V supply. If the EA<sub>OUT2</sub> pull-up resistor connects to a 10 V to 20 V supply, the output is specified to a minimum of 5.0 V to allow use with a PWM controller requiring a minimum input operation of 5 V.

### ACCURACY CIRCUIT OPERATION

See Figure 27 and Figure 28 for stability of the accuracy circuits. The op amp on the right side of the ADuM3190, from the -IN pin to the COMP pin, has a unity-gain bandwidth (UGBW) of 10 MHz. Figure 30, Bode Plot 1, shows a dashed line for the op amp alone and its 10 MHz pole.

Figure 30 also shows the linear isolator alone (the blocks from the op amp output to the ADuM3190 output, labeled as the linear isolator), which introduces a pole at approximately 400 kHz. This total Bode plot of the op amp and linear isolator shows that the phase shift is approximately  $-180^\circ$  from the -IN pin to the EA<sub>OUT</sub> pin before the crossover frequency. Because a  $-180^\circ$  phase shift can make the system unstable, adding an integrator configuration, as shown in the test circuits in Figure 27 and Figure 28, consisting of a 2.2 nF capacitor and a 680  $\Omega$  resistor, helps to make the system stable. In Figure 31, Bode Plot 2 with an integrator configuration added, the system crosses over 0 dB at

approximately 100 kHz, but the circuit is more stable with a phase shift of approximately  $-120^\circ$ , which yields a stable  $60^\circ$  phase margin.

This circuit is used for accuracy tests only, not for real-world applications, because it has a 680  $\Omega$  resistor across the isolation barrier to close the loop for the error amplifier; this resistor causes leakage current to flow across the isolation barrier. For this test circuit only, GND<sub>1</sub> must be connected to GND<sub>2</sub> to create a return for the leakage current created by the 680  $\Omega$  resistor connection.

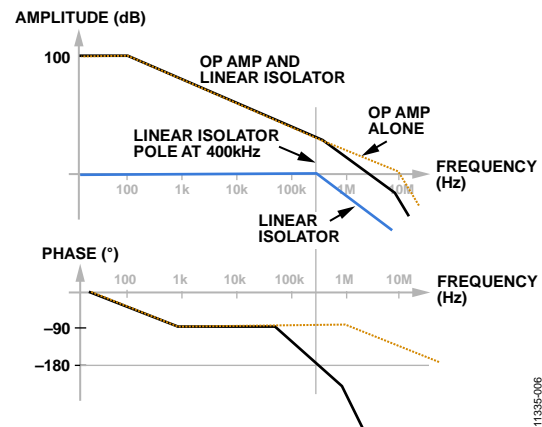

Figure 30. Bode Plot 1

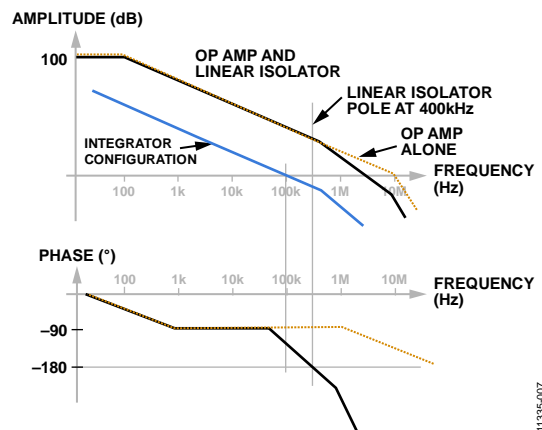

Figure 31. Bode Plot 2

### ISOLATED AMPLIFIER CIRCUIT OPERATION

Figure 29 shows an isolated amplifier circuit. In this circuit, the input side amplifier is set as a unity-gain buffer so that the EA<sub>OUT</sub> output follows the +IN input. The EA<sub>OUT2</sub> output follows the EA<sub>OUT</sub> output, but with a voltage gain of 2.6.

This circuit has an open-drain output, which must be pulled up to a supply voltage from 3 V to 20 V using a resistor value set for an output current of up to 1 mA. The EA<sub>OUT2</sub> output can be used to drive up to 1 mA to the input of a device that requires a minimum input operation of 5 V. The EA<sub>OUT2</sub> circuit has an internal diode clamp to protect the internal circuits from voltages greater than 5 V.

The gain, offset, and linearity of EA<sub>OUT</sub> and EA<sub>OUT2</sub> are specified in Table 1 using this test circuit. When designing applications for voltage monitoring using an isolated amplifier, review these specifications, noting that the 1% accuracy specifications for the isolated error amplifier do not apply. In addition, the EA<sub>OUT</sub> circuit in Figure 29 is shown with an optional external RC low-pass filter with a corner frequency of 500 kHz, which can reduce the 3 MHz output noise from the internal voltage to the PWM converter.

## APPLICATION BLOCK DIAGRAM

Figure 32 shows a typical application for the ADuM3190: an isolated error amplifier in primary side control.

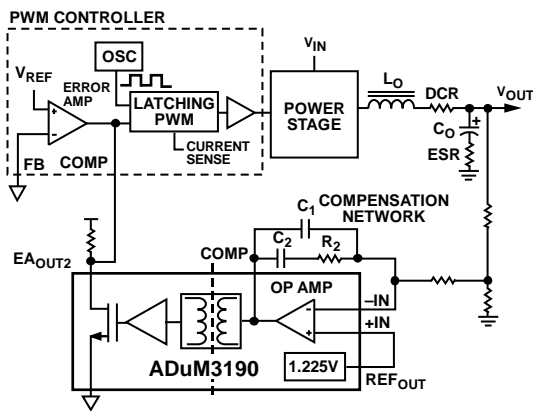

Figure 32. Application Block Diagram

The op amp of the ADuM3190 is used as the error amplifier for the feedback of the output voltage, V<sub>OUT</sub>, using a resistor divider to the -IN pin of the op amp. This configuration inverts the output signal at the COMP pin when compared to the +IN pin, which is connected to the internal 1.225 V reference.

For example, when the output voltage, V<sub>OUT</sub>, falls due to a load step, the divider voltage at the -IN pin falls below the +IN reference voltage, causing the COMP pin output signal to go high.

The COMP output of the op amp is encoded and then decoded by the digital isolator transformer block to a signal that drives the output of the ADuM3190 high. The output of the ADuM3190 drives the COMP pin of the PWM controller, which is designed to reset the PWM latch output to low only when its COMP pin is low. A high at the COMP pin of the PWM controller causes the latching PWM comparator to produce a PWM duty cycle output. This PWM duty cycle output drives the power stage to increase the V<sub>OUT</sub> voltage until it returns to regulation.

The power stage output is filtered by output capacitance and, in some applications, by an inductor. Various elements contribute to the gain and phase of the control loop and the resulting stability. The output filter components (L<sub>O</sub> and C<sub>O</sub>) create a double pole; the op amp has a pole at 10 MHz (see Figure 30), and the linear isolator has a pole at 400 kHz (see Figure 30 and Figure 31).

The output capacitor and its ESR can add a zero at a frequency that is dependent on the component type and values. With the ADuM3190 providing the error amplifier, a compensation network is provided from the -IN pin to the COMP pin to compensate

the control loop for stability. The compensation network values depend on both the application and the components that are selected; information about the component network values is provided in the data sheet of the selected PWM controller.

The ADuM3190 has two different error amplifier outputs: EA<sub>OUT</sub> and EA<sub>OUT2</sub>. The EA<sub>OUT</sub> output, which can drive ±3 mA, has a guaranteed maximum high output voltage of at least 2.4 V, which may not be sufficient to drive the COMP pin of some PWM controllers. The EA<sub>OUT2</sub> pin can drive ±1 mA and has an output range that guarantees 5.0 V for a V<sub>DD1</sub> voltage range of 10 V to 20 V, which works well with the COMP pin of many PWM controllers.

Figure 32 shows how to use the ADuM3190 to provide isolated feedback in the control loop of an isolated dc-to-dc converter. In this application block diagram, the loop is closed at approximately the 1.225 V reference voltage, providing ±1% accuracy over temperature. The ADuM3190 op amp has a high gain bandwidth of 10 MHz to allow the dc-to-dc converter to operate at high switching speeds, enabling smaller values for the output filter components (L<sub>O</sub> and C<sub>O</sub>).

The 400 kHz bandwidth of the ADuM3190 error amplifier output offers faster loop response for better transient response than the typical shunt regulator and optocoupler solutions, which typically have bandwidths of only 25 kHz to 50 kHz maximum.

## SETTING THE OUTPUT VOLTAGE

The output voltage in the application circuit can be set with two resistors in a voltage divider, as shown in Figure 33.

The output voltage is determined by the following equation where V<sub>REF</sub> = 1.225 V.

$$V_{OUT} = V_{REF} \times (R_1 + R_2)/R_2 \quad (1)$$

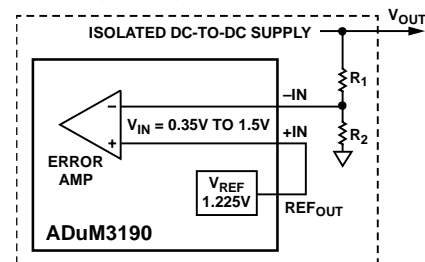

Figure 33. Setting the Output Voltage

## DOSA MODULE APPLICATION

Figure 34 is a block diagram of a Distributed-power Open Standards Alliance (DOSA) circuit using the ADuM3190. The block diagram shows how to use the ADuM3190 1.225 V reference and the error amp in a DOSA standard power supply module circuit to produce output voltage settings using a combination of resistors.

The ADuM3190 1.225 V reference is specified for ±1% over the -40°C to +125°C temperature range. See Table 10 to select the resistor values to set the output voltage of the module. Two different ranges of V<sub>OUT</sub> can be implemented, V<sub>OUT</sub> > 1.5 V or V<sub>OUT</sub> < 1.5 V, depending on the required module.

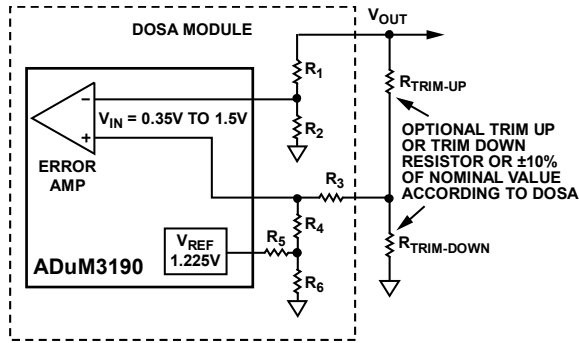

Figure 34. DOSA Module

Table 10. Resistor Values for DOSA Module

Module Nominal Output	R3	R4	R5	R6
V <sub>OUT</sub> > 1.5 V	1 kΩ	1 kΩ	0 Ω	Open
V <sub>OUT</sub> < 1.5 V	1 kΩ	0 Ω	2.05 kΩ	1.96 kΩ
V <sub>OUT</sub> > 1.5 V	5.11 kΩ	5.11 kΩ	0 Ω	Open
V <sub>OUT</sub> < 1.5 V	5.11 kΩ	0 Ω	10.5 kΩ	10.0 kΩ

**DC CORRECTNESS AND MAGNETIC FIELD IMMUNITY**

Positive and negative logic transitions at the isolator input cause narrow (~1 ns) pulses to be sent to the decoder via the transformer. The decoder is bistable and is, therefore, either set or reset by the pulses, indicating input logic transitions. In the absence of logic transitions of more than 1 μs at the input, a periodic set of refresh pulses indicative of the correct input state are sent to ensure dc correctness at the output.

If the decoder receives no internal pulses for more than approximately 3 μs, the input side is assumed to be unpowered or nonfunctional, in which case the isolator output is forced to a default high impedance state by the watchdog timer circuit. In addition, the outputs are in a default high impedance state while the power is increasing before the UVLO threshold is crossed.

The ADuM3190 is immune to external magnetic fields. The limitation on the ADuM3190 magnetic field immunity is set by the condition whereby induced voltage in the transformer receiving coil is sufficiently large to either falsely set or reset the decoder. The following analysis defines the conditions under which this can occur. The 3 V operating condition of the ADuM3190 is examined because it represents the most susceptible mode of operation. The pulses at the transformer output have an amplitude that is greater than 1.0 V. The decoder has a sensing threshold at approximately 0.5 V, therefore establishing a 0.5 V margin within which induced voltages are tolerated. The voltage induced across the receiving coil is given by

$$V = (-d\beta/dt) \sum \pi r_n^2, n = 1, 2, \dots, N$$

where:

$\beta$  is the magnetic flux density (gauss).

$r_n$  is the radius of the nth turn in the receiving coil (cm).

$N$  is the number of turns in the receiving coil.

Given the geometry of the receiving coil in the ADuM3190 and an imposed requirement that the induced voltage be, at most, 50% of the 0.5 V margin at the decoder, a maximum allowable magnetic field is calculated, as shown in Figure 35.

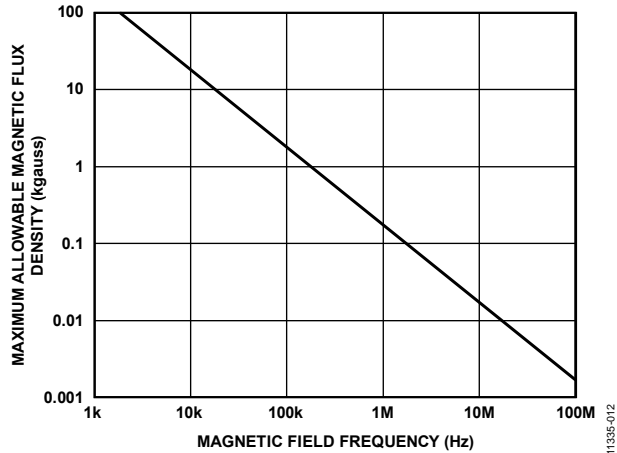

Figure 35. Maximum Allowable External Magnetic Flux Density

For example, at a magnetic field frequency of 1 MHz, the maximum allowable magnetic field of 0.02 kgauss induces a voltage of 0.25 V at the receiving coil. This is approximately 50% of the sensing threshold and does not cause a faulty output transition. Similarly, if such an event were to occur during a transmitted pulse (and had the worst-case polarity), the received pulse is reduced from >1.0 V to 0.75 V, still well above the 0.5 V sensing threshold of the decoder.

The preceding magnetic flux density values correspond to specific current magnitudes at given distances away from the ADuM3190 transformers. Figure 36 shows these allowable current magnitudes as a function of frequency for selected distances. As shown in Figure 36, the ADuM3190 is immune and can be affected only by extremely large currents operating at a high frequency very close to the component. For the 1 MHz example, a 0.7 kA current must be placed 5 mm away from the ADuM3190 to affect the operation of the device.

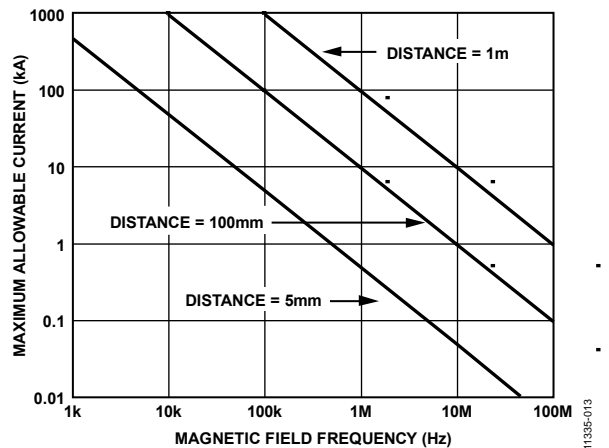

Figure 36. Maximum Allowable Current for Various Current-to-ADuM3190 Spacings



## INSULATION LIFETIME

All insulation structures eventually break down when subjected to voltage stress over a sufficiently long period. The rate of insulation degradation is dependent on the characteristics of the voltage waveform applied across the insulation. In addition to the testing performed by the regulatory agencies, Analog Devices carries out an extensive set of evaluations to determine the lifetime of the insulation structure within the ADuM3190.

Analog Devices performs accelerated life testing using voltage levels higher than the rated continuous working voltage. Acceleration factors for several operating conditions are determined. These factors allow calculation of the time to failure at the actual working voltage.

The values shown in Table 8 summarize the peak voltage for 50 years of service life for a bipolar ac operating condition. In many cases, the approved working voltage is higher than the 50-year service life voltage. Operation at these high working voltages can lead to shortened insulation life in some cases.

The ADuM3190 insulation lifetime depends on the voltage waveform type imposed across the isolation barrier. The *iCoupler* insulation structure degrades at different rates depending on whether the waveform is bipolar ac, unipolar ac, or dc. Figure 37, Figure 38, and Figure 39 illustrate these different isolation voltage waveforms.

A bipolar ac voltage environment is the worst case for the *iCoupler* products yet meets the 50-year operating lifetime recommended by Analog Devices for maximum working voltage. In the case of unipolar ac or dc voltage, the stress on the insulation is sig-

nificantly lower. This allows operation at higher working voltages while still achieving a 50-year service life. Treat any cross-insulation voltage waveform that does not conform to Figure 38 or Figure 39 as a bipolar ac waveform, and limit its peak voltage to the 50-year lifetime voltage value listed in Table 8.

Note that the voltage presented in Figure 38 is shown as sinusoidal for illustration purposes only. It is meant to represent any voltage waveform varying between 0 V and some limiting value. The limiting value can be positive or negative, but the voltage cannot cross 0 V.

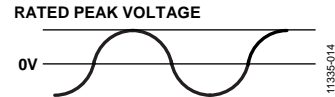

Figure 37. Bipolar AC Waveform

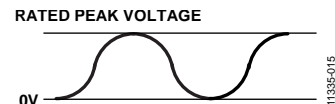

Figure 38. Unipolar AC Waveform

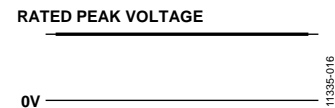
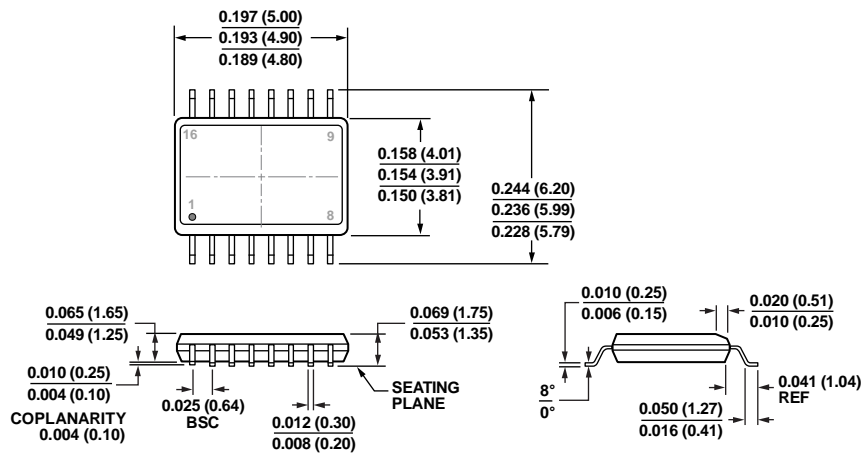

Figure 39. DC Waveform

## PACKAGING AND ORDERING INFORMATION

## OUTLINE DIMENSIONS



COMPLIANT TO JEDEC STANDARDS MO-137-AB  
CONTROLLING DIMENSIONS ARE IN INCHES; MILLIMETER DIMENSIONS  
(IN PARENTHESES) ARE ROUNDED-OFF INCH EQUIVALENTS FOR  
REFERENCE ONLY AND ARE NOT APPROPRIATE FOR USE IN DESIGN.

Figure 40. 16-Lead Shrink Small Outline Package [QSOP]  
(RQ-16)

Dimensions shown in inches and (millimeters)

09-1123014-A

## ORDERING GUIDE

Model <sup>1,2</sup>	Temperature Range	Bandwidth (Typical)	Package Description	Package Option
ADuM3190ARQZ	-40°C to +85°C	200 kHz	16-Lead QSOP	RQ-16
ADuM3190ARQZ-RL7	-40°C to +85°C	200 kHz	16-Lead QSOP	RQ-16
ADuM3190BRQZ	-40°C to +85°C	400 kHz	16-Lead QSOP	RQ-16
ADuM3190BRQZ-RL7	-40°C to +85°C	400 kHz	16-Lead QSOP	RQ-16
ADuM3190SRQZ	-40°C to +125°C	200 kHz	16-Lead QSOP	RQ-16
ADuM3190SRQZ-RL7	-40°C to +125°C	200 kHz	16-Lead QSOP	RQ-16
ADuM3190TRQZ	-40°C to +125°C	400 kHz	16-Lead QSOP	RQ-16
ADuM3190TRQZ-RL7	-40°C to +125°C	400 kHz	16-Lead QSOP	RQ-16
ADuM3190WSRQZ	-40°C to +125°C	200 kHz	16-Lead QSOP	RQ-16
ADuM3190WSRQZ-RL7	-40°C to +125°C	200 kHz	16-Lead QSOP	RQ-16
ADuM3190WTRQZ	-40°C to +125°C	400 kHz	16-Lead QSOP	RQ-16
ADuM3190WTRQZ-RL7	-40°C to +125°C	400 kHz	16-Lead QSOP	RQ-16
EVAL-ADuM3190EBZ			Evaluation Board	

<sup>1</sup> Z = RoHS Compliant Part.

<sup>2</sup> W = Qualified for Automotive Applications.

## AUTOMOTIVE PRODUCTS

The ADuM3190W models are available with controlled manufacturing to support the quality and reliability requirements of automotive applications. Note that these automotive models may have specifications that differ from the commercial models; therefore, designers should review the Specifications section of this data sheet carefully. Only the automotive grade products shown are available for use in automotive applications. Contact your local Analog Devices account representative for specific product ordering information and to obtain the specific Automotive Reliability reports for these models.