



GaAs pHEMT MMIC 1/2 WATT POWER AMPLIFIER, 16 - 24 GHz

Typical Applications

The HMC757LP4E is ideal for:

- Point-to-Point Radios
- Point-to-Multi-Point Radios
- VSAT
- Military & Space

Features

- Saturated Output Power: 27.5 dBm @ 21% PAE
- High Output IP3: 34.5 dBm
- High Gain: 20.5 dB
- DC Supply: +5V @ 400 mA
- No External Matching Required
- 24 Lead 4x4 mm SMT Package: 16 mm²

Functional Diagram

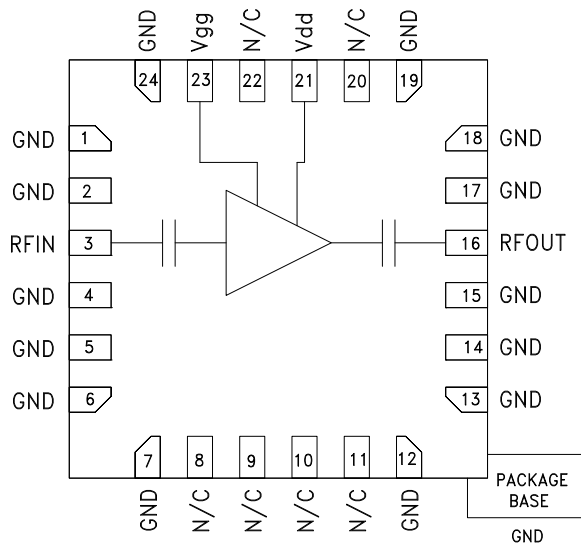

General Description

The HMC757LP4E is a three stage GaAs pHEMT MMIC 1 Watt Power Amplifier which operates between 16 and 24 GHz. The HMC757LP4E provides 20.5 dB of gain, and 27.5 dBm of saturated output power and 21% PAE from a +5V supply. The RF I/Os are DC blocked and matched to 50 Ohms. The 4x4 mm plastic package eliminates the need for wirebonding, and is compatible with surface mount manufacturing techniques.

Electrical Specifications, $T_A = +25^\circ C$, $V_{dd} = +5V$, $I_{dd} = 400mA$ [1]

Parameter	Min.	Typ.	Max.	Units
Frequency Range	16 - 24			GHz
Gain	18.5	20.5		dB
Gain Variation Over Temperature		0.028		dB/ °C
Input Return Loss		11		dB
Output Return Loss		12		dB
Output Power for 1 dB Compression (P1dB)	24.5	26.5		dBm
Saturated Output Power (P _{sat})		27.5		dBm
Output Third Order Intercept (IP ₃) ^[2]		34.5		dBm
Total Supply Current (I _{dd})		400		mA

[1] Adjust V_{gg} between -2 to 0V to achieve I_{dd} = 400 mA typical.

[2] Measurement taken at P_{out} / Tone = +16 dBm



**GaAs pHEMT MMIC 1/2 WATT
POWER AMPLIFIER, 16 - 24 GHz**

**Broadband Gain &
Return Loss vs. Frequency**

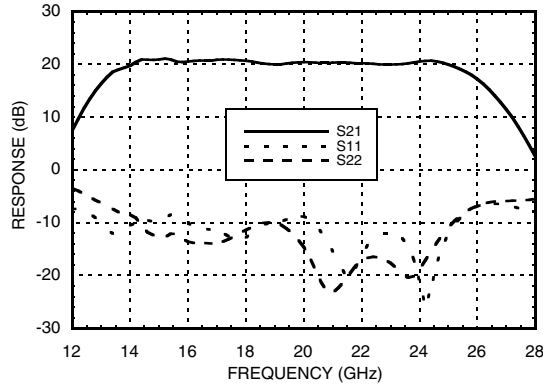

Gain vs. Temperature

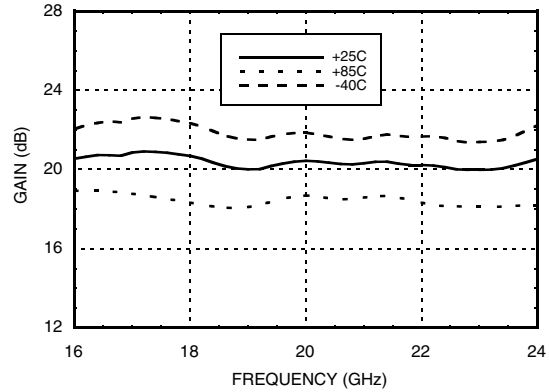

Input Return Loss vs. Temperature

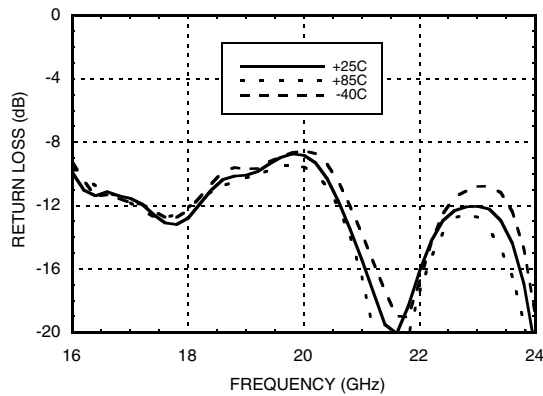

Output Return Loss vs. Temperature

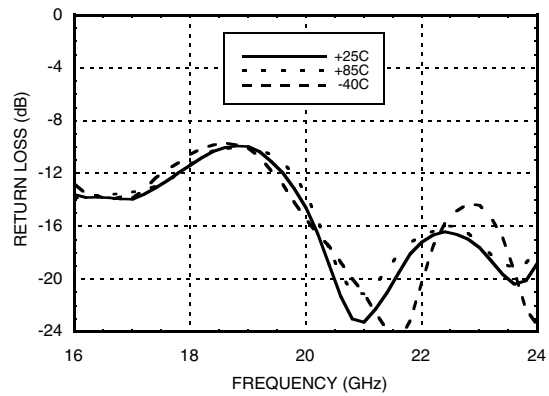

P1dB vs. Temperature

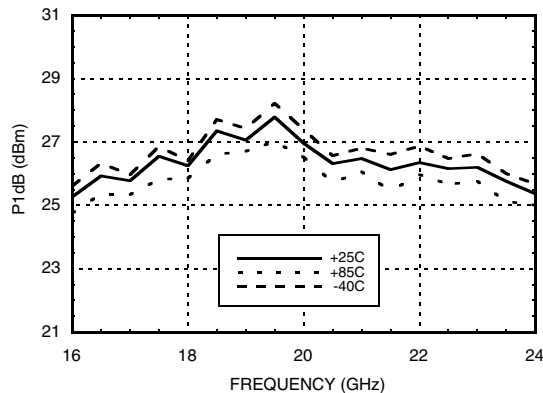

P1dB vs. Supply Voltage

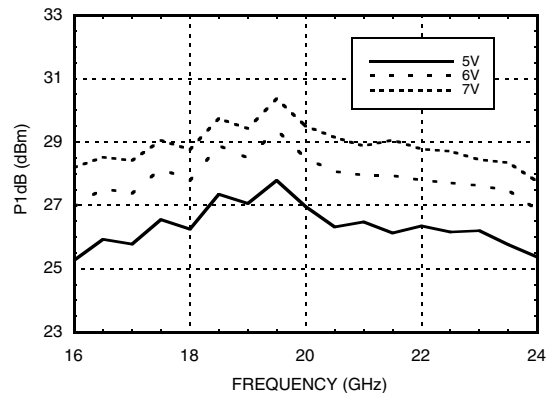

Information furnished by Analog Devices is believed to be accurate and reliable. However, no responsibility is assumed by Analog Devices for its use, nor for any infringements of patents or other rights of third parties that may result from its use. Specifications subject to change without notice. No license is granted by implication or otherwise under any patent or patent rights of Analog Devices. Trademarks and registered trademarks are the property of their respective owners.

For price, delivery, and to place orders: Analog Devices, Inc., One Technology Way, P.O. Box 9106, Norwood, MA 02062-9106 Phone: 781-329-4700 • Order online at www.analog.com Application Support: Phone: 1-800-ANALOG-D



**GaAs pHEMT MMIC 1/2 WATT
POWER AMPLIFIER, 16 - 24 GHz**

Psat vs. Temperature

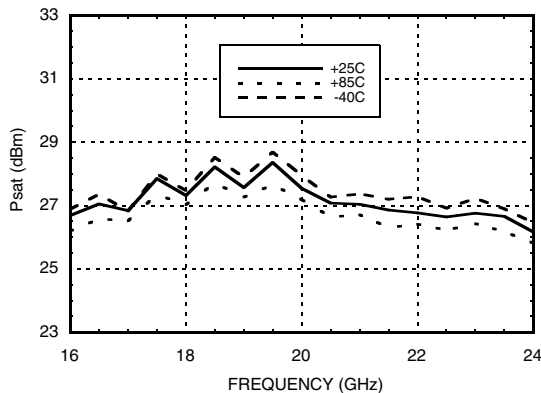

Psat vs. Supply Voltage

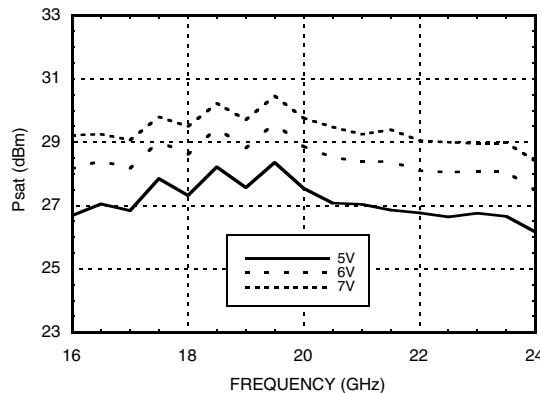

P1dB vs. Supply Current (Idd)

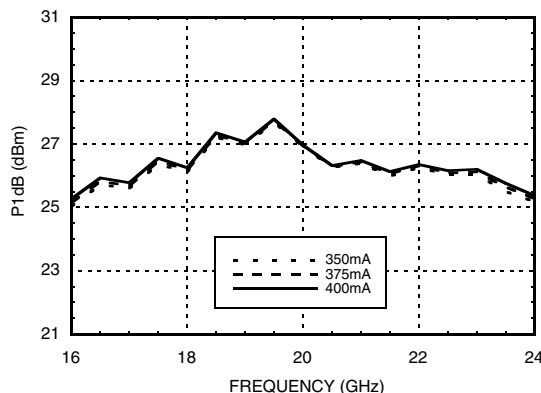

Psat vs. Supply Current (Idd)

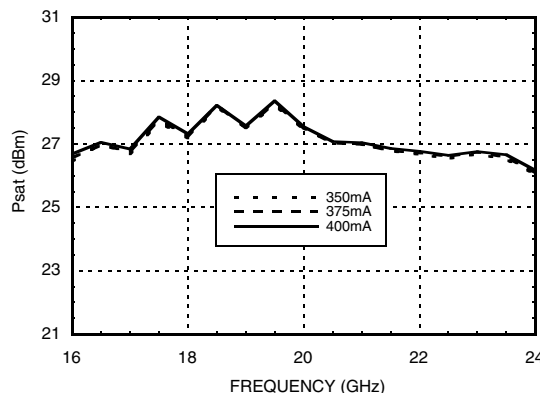

Output IP3 vs. Temperature, Pout/Tone = +16 dBm

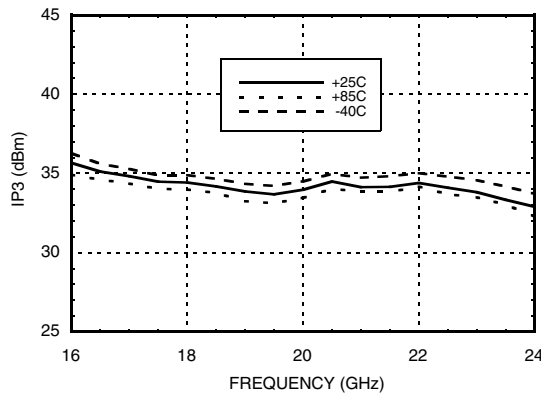

Output IP3 vs. Supply Current, Pout/Tone = +16 dBm

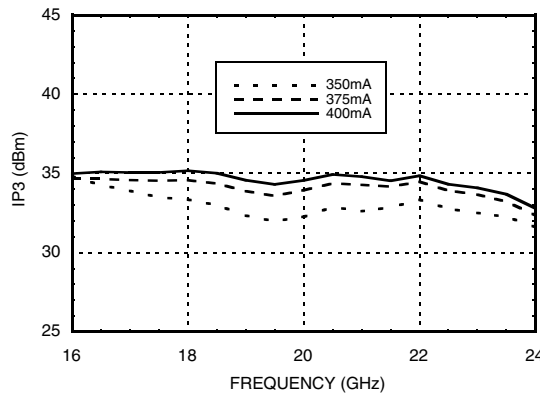

Information furnished by Analog Devices is believed to be accurate and reliable. However, no responsibility is assumed by Analog Devices for its use, nor for any infringements of patents or other rights of third parties that may result from its use. Specifications subject to change without notice. No license is granted by implication or otherwise under any patent or patent rights of Analog Devices. Trademarks and registered trademarks are the property of their respective owners.

For price, delivery, and to place orders: Analog Devices, Inc., One Technology Way, P.O. Box 9106, Norwood, MA 02062-9106 Phone: 781-329-4700 • Order online at www.analog.com Application Support: Phone: 1-800-ANALOG-D



GaAs pHEMT MMIC 1/2 WATT POWER AMPLIFIER, 16 - 24 GHz

Output IP3 vs. Supply Voltage, Pout/Tone = +16 dBm

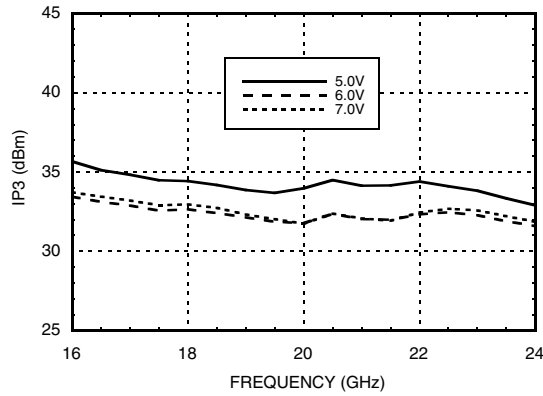

Output IM3 @ Vdd = +5V

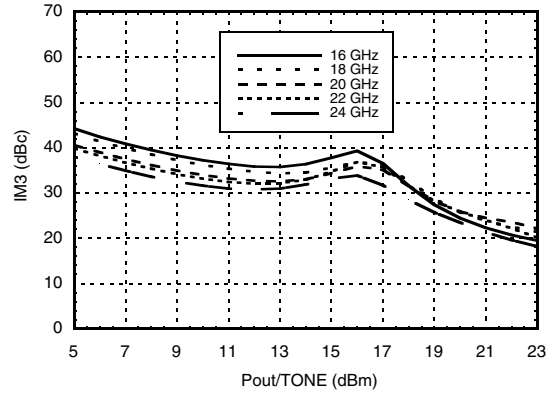

Output IM3 @ Vdd = +6V

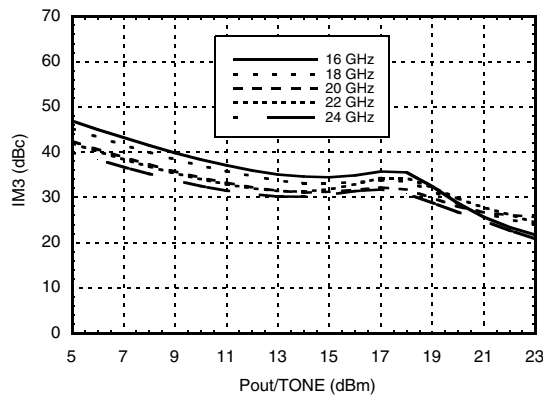

Output IM3 @ Vdd = +7V

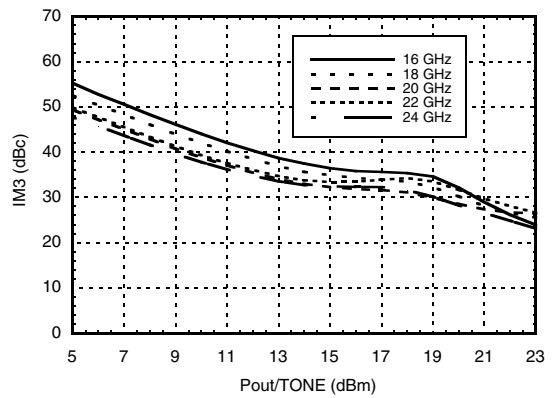

Power Compression @ 20 GHz

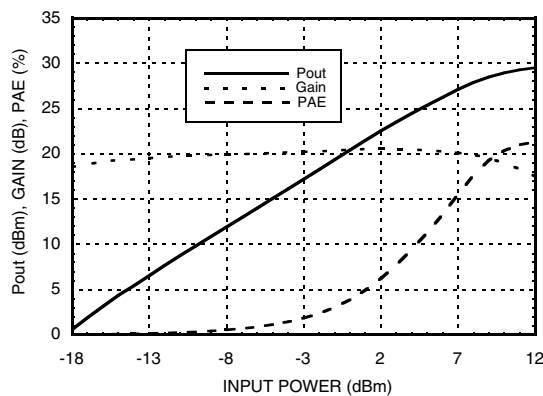

Reverse Isolation vs. Temperature

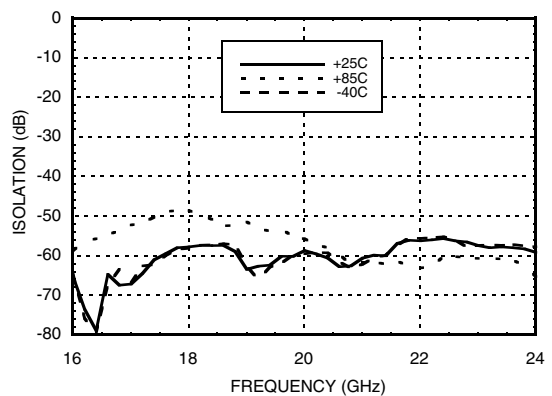

Information furnished by Analog Devices is believed to be accurate and reliable. However, no responsibility is assumed by Analog Devices for its use, nor for any infringements of patents or other rights of third parties that may result from its use. Specifications subject to change without notice. No license is granted by implication or otherwise under any patent or patent rights of Analog Devices. Trademarks and registered trademarks are the property of their respective owners.

For price, delivery, and to place orders: Analog Devices, Inc., One Technology Way, P.O. Box 9106, Norwood, MA 02062-9106 Phone: 781-329-4700 • Order online at www.analog.com Application Support: Phone: 1-800-ANALOG-D



**GaAs pHEMT MMIC ½ WATT
POWER AMPLIFIER, 16 - 24 GHz**

**Gain & Power vs.
Supply Current @ 20 GHz**

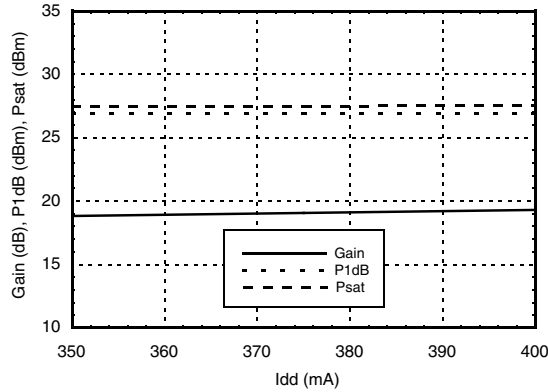

**Gain & Power vs.
Supply Voltage @ 20 GHz**

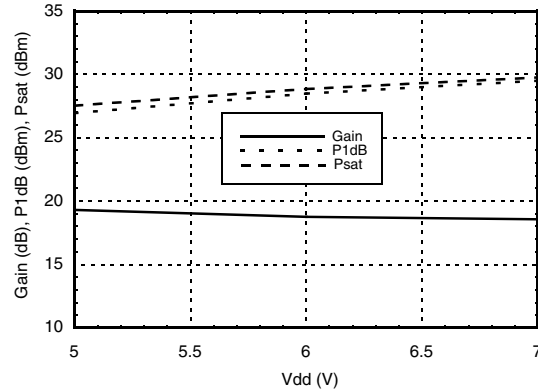

Power Dissipation

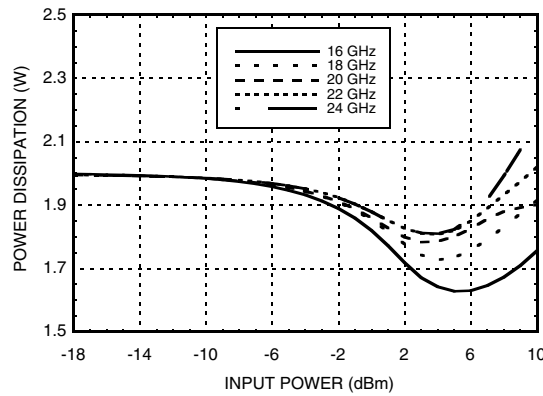

Absolute Maximum Ratings

Drain Bias Voltage (V _{dd})	7V
RF Input Power (RFIN)	23 dBm
Channel Temperature	150 °C
Continuous Pdiss (T= 85 °C) (derate 40 mW/°C above 85 °C)	2.7 W
Thermal Resistance (channel to exposed ground paddle)	24.85 C/W
Storage Temperature	-65 to +150 °C
Operating Temperature	-55 to +85 °C

Typical Supply Current vs. V_{dd}

V _{dd} (V)	I _{dd} (mA)
+5.0	400
+5.5	400
+6.0	400

Note: Amplifier will operate over full voltage ranges shown above V_{gg} adjusted to achieve I_{dd} = 400 mA at +5.5V



**ELECTROSTATIC SENSITIVE DEVICE
OBSERVE HANDLING PRECAUTIONS**

Information furnished by Analog Devices is believed to be accurate and reliable. However, no responsibility is assumed by Analog Devices for its use, nor for any infringements of patents or other rights of third parties that may result from its use. Specifications subject to change without notice. No license is granted by implication or otherwise under any patent or patent rights of Analog Devices. Trademarks and registered trademarks are the property of their respective owners.

For price, delivery, and to place orders: Analog Devices, Inc., One Technology Way, P.O. Box 9106, Norwood, MA 02062-9106 Phone: 781-329-4700 • Order online at www.analog.com Application Support: Phone: 1-800-ANALOG-D

**GaAs pHEMT MMIC ½ WATT
POWER AMPLIFIER, 16 - 24 GHz**



Outline Drawing

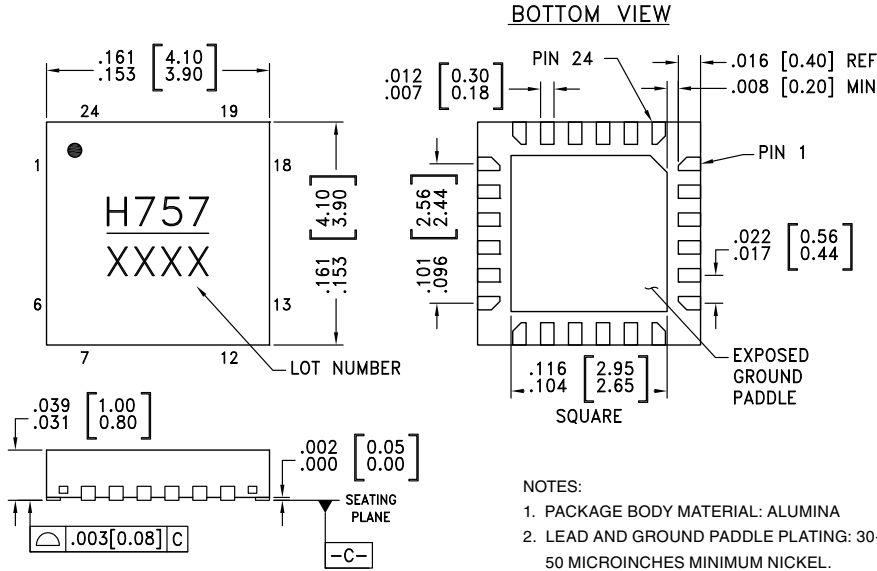

NOTES:

1. PACKAGE BODY MATERIAL: ALUMINA
2. LEAD AND GROUND PADDLE PLATING: 30-80 MICROINCHES GOLD OVER 50 MICROINCHES MINIMUM NICKEL.
3. DIMENSIONS ARE IN INCHES [MILLIMETERS].
4. LEAD SPACING TOLERANCE IS NON-CUMULATIVE
5. PACKAGE WARP SHALL NOT EXCEED 0.05mm DATUM **-C-**
6. ALL GROUND LEADS AND GROUND PADDLE MUST BE SOLDERED TO PCB RF GROUND.
7. CLASSIFIED AS MOISTURE SENSITIVITY LEVEL (MSL) 1.

Package Information

Part Number	Package Body Material	Lead Finish	MSL Rating	Package Marking ^[1]
HMC757LP4E	RoHS-compliant Low Stress Injection Molded Plastic	100% matte Sn	MSL1 ^[2]	H757 XXXX

[1] 4-Digit lot number XXXX

[2] Max peak reflow temperature of 260 °C

GaAs pHEMT MMIC ½ WATT POWER AMPLIFIER, 16 - 24 GHz



Pin Descriptions

Pin Number	Function	Description	Interface Schematic
1, 2, 4 - 7, 12 - 15, 17 - 19, 24	GND	These pins and package bottom must be connected to RF/DC ground.	
3	RFIN	This pin is AC coupled and matched to 50 Ohms.	
8 - 11, 20, 22	N/C	The pins are not connected internally; however, all data shown herein was measured with these pins connected to RF/DC ground externally.	
16	RFOUT	This pin is AC coupled and matched to 50 Ohms.	
21	Vdd	Drain bias for amplifier. External bypass caps 100pF, 0.1uF and 4.7uF are required	
23	Vgg	Gate control for PA. Adjust Vgg to achieve recommended bias current. External bypass caps 100pF, 0.1uF and 4.7uF are required.	

Application Circuit

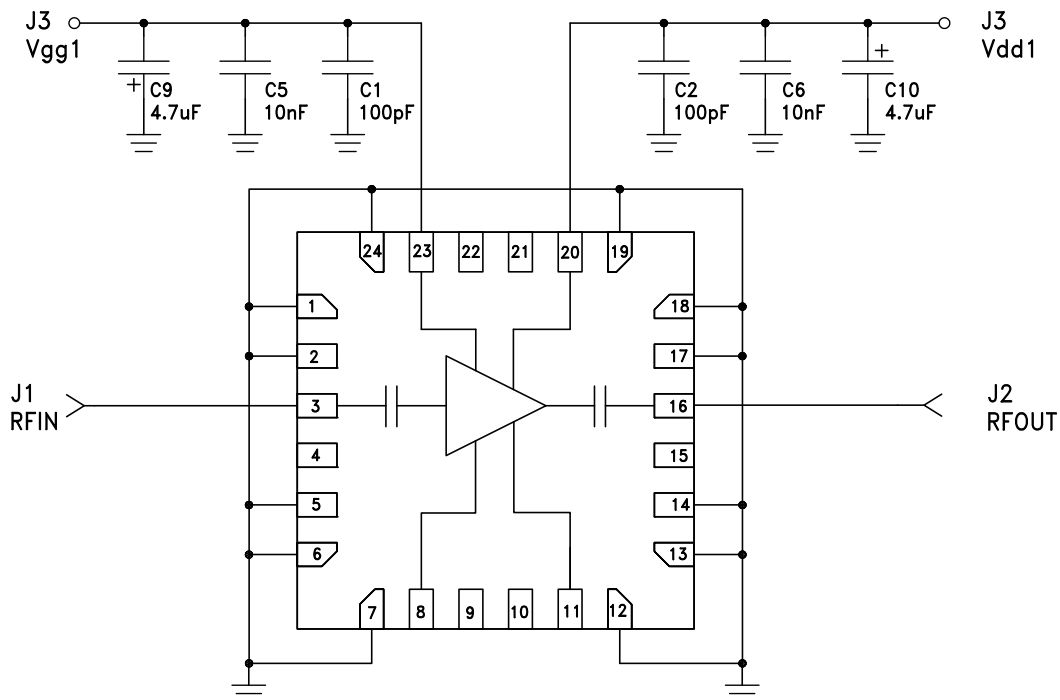

Information furnished by Analog Devices is believed to be accurate and reliable. However, no responsibility is assumed by Analog Devices for its use, nor for any infringements of patents or other rights of third parties that may result from its use. Specifications subject to change without notice. No license is granted by implication or otherwise under any patent or patent rights of Analog Devices. Trademarks and registered trademarks are the property of their respective owners.

For price, delivery, and to place orders: Analog Devices, Inc., One Technology Way, P.O. Box 9106, Norwood, MA 02062-9106
Phone: 781-329-4700 • Order online at www.analog.com
Application Support: Phone: 1-800-ANALOG-D

**GaAs pHEMT MMIC ½ WATT
POWER AMPLIFIER, 16 - 24 GHz**



Evaluation PCB

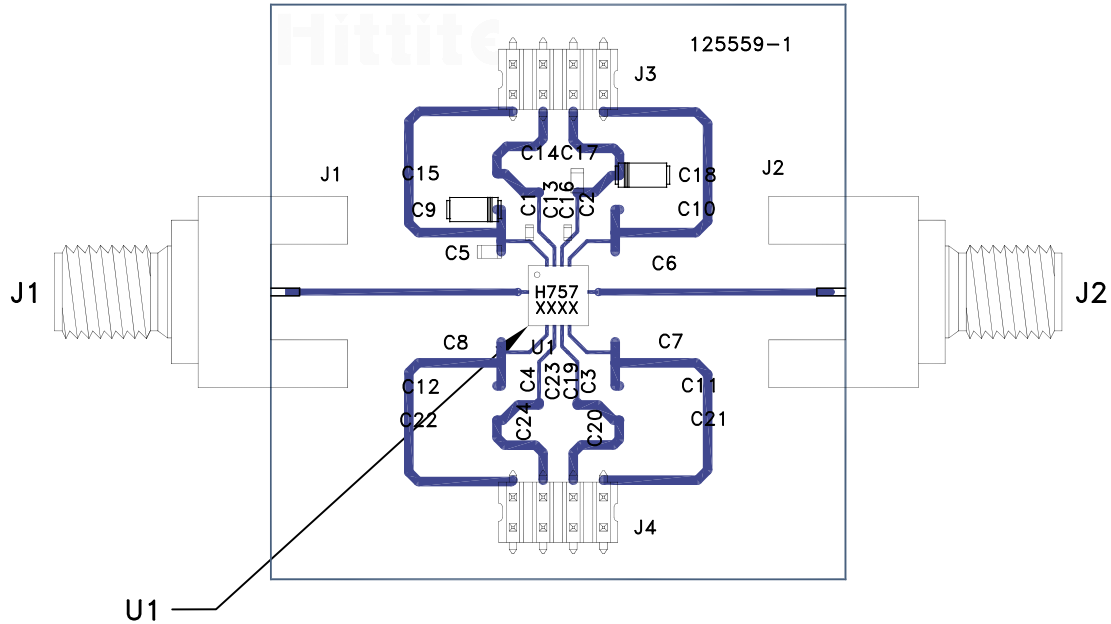

List of Materials for Evaluation PCB 131216 [1]

Item	Description
J1, J2	2.9 mm Connectors
J3, J4	DC Pins
C1, C16	100 pF Capacitor, 0402 Pkg.
C5, C17	10 kpF Capacitor, 0402 Pkg.
C9, C18	4.7 µF Capacitor, 0402 Pkg.
U1	HMC757LP4E Power Amplifier
PCB [2]	125559 Evaluation PCB

[1] Reference this number when ordering complete evaluation PCB

[2] Circuit Board Material: Rogers 4350 or Arlon FR4

The circuit board used in the application should use RF circuit design techniques. Signal lines should have 50 Ohm impedance while the package ground leads and exposed paddle should be connected directly to the ground plane similar to that shown. A sufficient number of via holes should be used to connect the top and bottom ground planes. The evaluation board should be mounted to an appropriate heat sink. The evaluation circuit board shown is available from Hittite upon request.