

## GaAs MMIC VOLTAGE-VARIABLE ATTENUATOR, DC - 14 GHz



### Typical Applications

The HMC346LP3 / HMC346LP3E is ideal for:

- Basestation Infrastructure
- Fiber Optics & Broadband Telecom
- Microwave Radio & VSAT
- Military Radios, Radar, & ECM
- Test Instrumentation

### Features

- Wide Bandwidth: DC - 14 GHz
- Low Phase Shift vs. Attenuation
- 30 dB Attenuation Range
- Simplified Voltage Control
- 3 x 3 x 1 mm SMT Package

### Functional Diagram

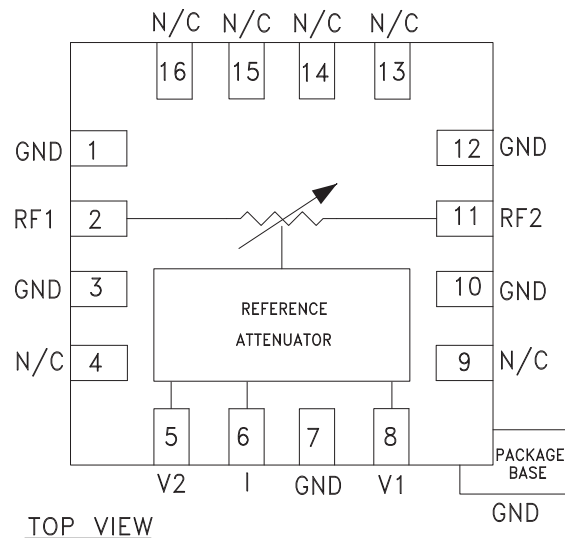

### General Description

The HMC346LP3 & HMC346LP3E are pabsorp-tive Voltage Variable Attenuators (VVA) in low cost leadless surface mount plastic packages operating from DC - 14 GHz. It features an on-chip reference attenuator for use with an external op-amp to provide simple single voltage attenuation control, 0 to -3V. The device is ideal in designs where an analog DC control signal must control RF signal levels over a 30 dB amplitude range. This VVA is an excellent alterna-tive to the HMC121C8.

### Electrical Specifications, $T_A = +25^\circ C$ , 50 ohm system

| Parameter  | Min                               | Typical | Max | Units |
|--|-----------------------------------|---------|-----|-------|
| Insertion Loss   | DC - 10 GHz                       | 1.7     | 2.2 | dB    |
|  | DC - 14 GHz                       | 2.8     | 3.3 | dB    |
| Attenuation Range  | DC - 10 GHz                       | 27      | 30  | dB    |
|  | DC - 14 GHz                       | 22      | 27  | dB    |
| Return Loss  | DC - 14 GHz                       | 5       | 10  | dB    |
| Switching Characteristics  | tRISE, tFALL (10/90% RF):         | 2       |     | ns    |
|  | tON, tOFF (50% CTL to 10/90% RF): | 8       |     | ns    |
| Input Power for 0.25 dB Compression (0.5 - 8 GHz)                                      | Min. Atten:                       | +8      |     | dBm   |
|  | Atten. >2 dB:                     | -4      |     | dBm   |
| Input Third Order Intercept (0.5 - 8 GHz)<br>(Two-tone Input Power = -8 dBm Each Tone) | Min. Atten:                       | +25     |     | dBm   |
|  | Atten. >2 dB:                     | +10     |     | dBm   |

Information furnished by Analog Devices is believed to be accurate and reliable. However, no responsibility is assumed by Analog Devices for its use, nor for any infringements of patents or other rights of third parties that may result from its use. Specifications subject to change without notice. No license is granted by implication or otherwise under any patent or patent rights of Analog Devices. Trademarks and registered trademarks are the property of their respective owners.

For price, delivery, and to place orders: Analog Devices, Inc., One Technology Way, P.O. Box 9106, Norwood, MA 02062-9106 Phone: 781-329-4700 • Order online at [www.analog.com](http://www.analog.com) Application Support: Phone: 1-800-ANALOG-D



**GaAs MMIC VOLTAGE-VARIABLE ATTENUATOR, DC - 14 GHz**

**Insertion Loss vs. Temperature**

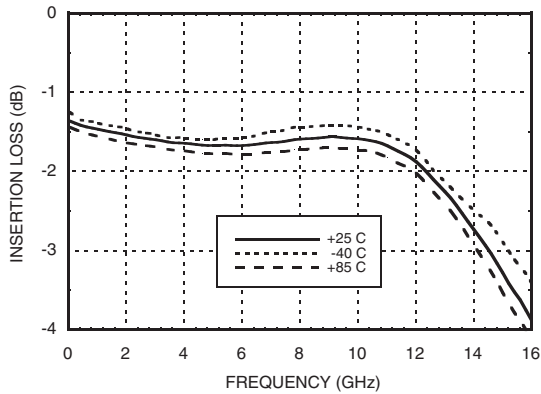

**Relative Attenuation**

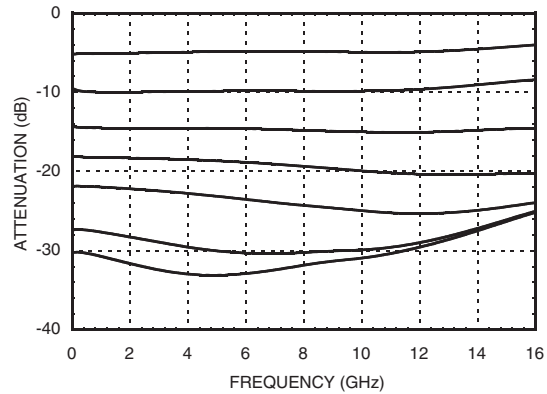

**Return Loss vs. Attenuation**

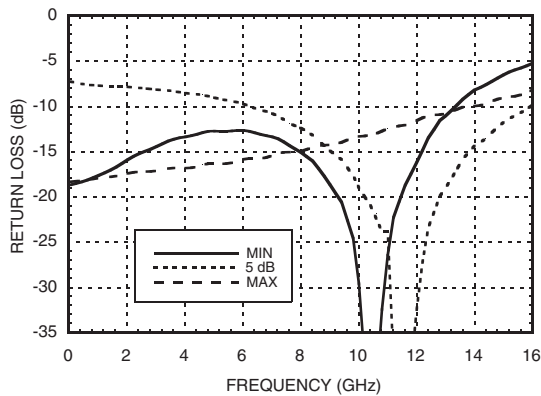

**Relative Attenuation vs. Control Voltage @ 10 GHz**

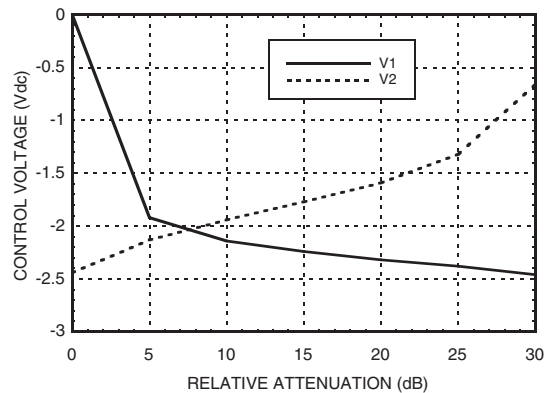

**Relative Phase**

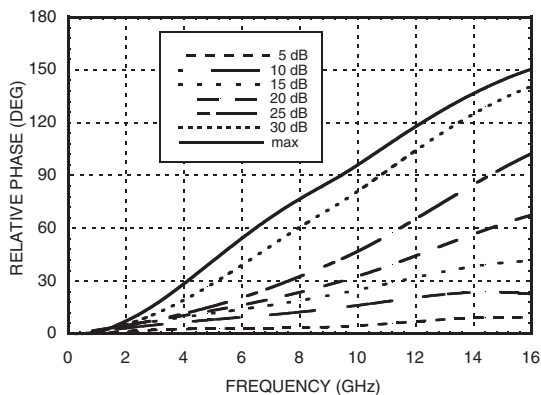

**Input IP3 vs. Attenuation\***

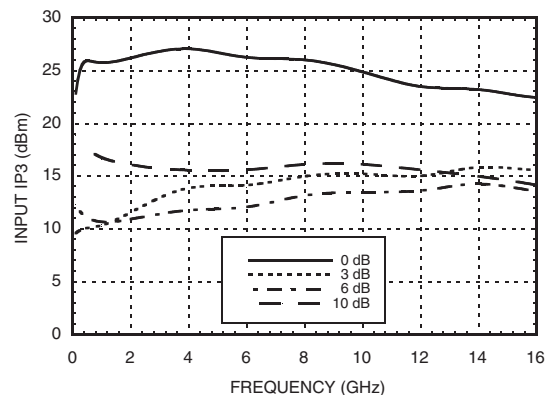

\*Two-tone input power = -8 dBm each tone, 1 MHz spacing.

Information furnished by Analog Devices is believed to be accurate and reliable. However, no responsibility is assumed by Analog Devices for its use, nor for any infringements of patents or other rights of third parties that may result from its use. Specifications subject to change without notice. No license is granted by implication or otherwise under any patent or patent rights of Analog Devices. Trademarks and registered trademarks are the property of their respective owners.

For price, delivery, and to place orders: Analog Devices, Inc., One Technology Way, P.O. Box 9106, Norwood, MA 02062-9106 Phone: 781-329-4700 • Order online at [www.analog.com](http://www.analog.com) Application Support: Phone: 1-800-ANALOG-D



**GaAs MMIC VOLTAGE-VARIABLE  
ATTENUATOR, DC - 14 GHz**

5

ATTENUATORS - SMT

**Input IP2 vs. Attenuation\***

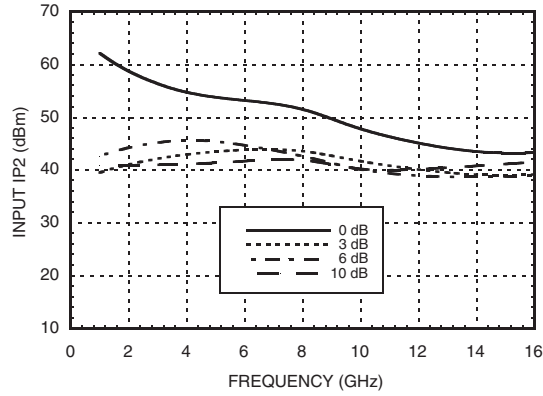

**Second Harmonic vs. Attenuation, Pin = -8 dBm**

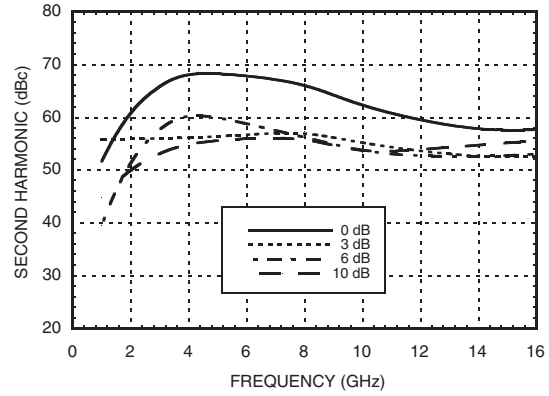

**0.25 dB Compression vs. Attenuation**

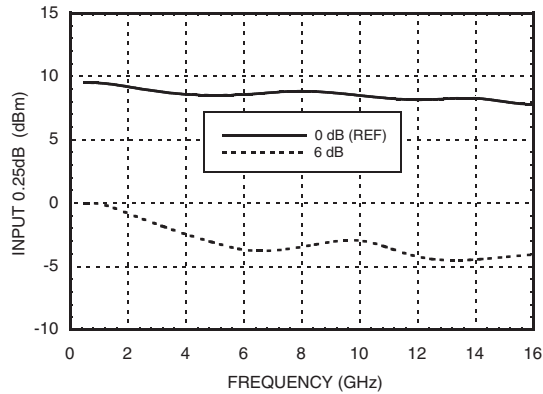

**1 dB Compression vs. Attenuation**

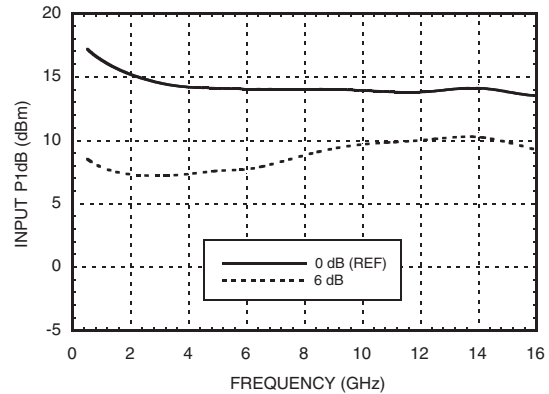

\*Two-tone input power = -8 dBm each tone, 1 MHz spacing.

Information furnished by Analog Devices is believed to be accurate and reliable. However, no responsibility is assumed by Analog Devices for its use, nor for any infringements of patents or other rights of third parties that may result from its use. Specifications subject to change without notice. No license is granted by implication or otherwise under any patent or patent rights of Analog Devices. Trademarks and registered trademarks are the property of their respective owners.

For price, delivery, and to place orders: Analog Devices, Inc., One Technology Way, P.O. Box 9106, Norwood, MA 02062-9106 Phone: 781-329-4700 • Order online at [www.analog.com](http://www.analog.com) Application Support: Phone: 1-800-ANALOG-D

## GaAs MMIC VOLTAGE-VARIABLE ATTENUATOR, DC - 14 GHz



### Absolute Maximum Ratings

|                       |                |
|-----------------------|----------------|
| RF Input Power        | +18 dBm        |
| Control Voltage Range | +1 to -5V      |
| Storage Temperature   | -65 to +150 °C |
| Operating Temperature | -40 to +85 °C  |
| ESD Sensitivity (HBM) | Class 1A       |



ELECTROSTATIC SENSITIVE DEVICE  
OBSERVE HANDLING PRECAUTIONS

### Outline Drawing

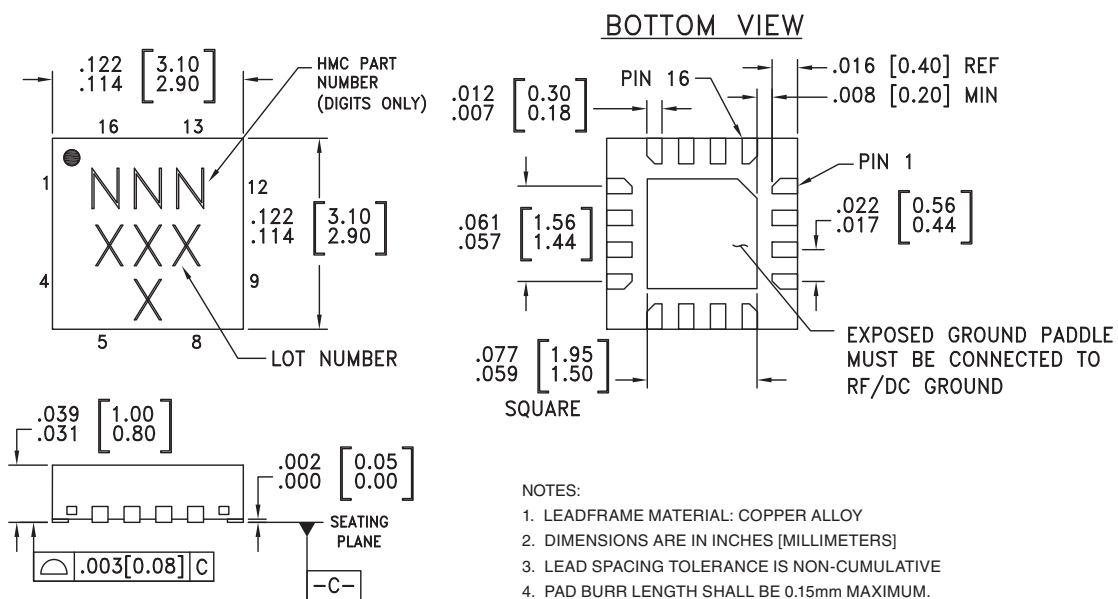

### Package Information

| Part Number | Package Body Material                              | Lead Finish   | MSL Rating          | Package Marking <sup>[3]</sup> |
|-------------|--|---------------|---------------------|--------------------------------|
| HMC346LP3   | Low Stress Injection Molded Plastic                | Sn/Pb Solder  | MSL1 <sup>[1]</sup> | 346<br>XXXX                    |
| HMC346LP3E  | RoHS-compliant Low Stress Injection Molded Plastic | 100% matte Sn | MSL1 <sup>[2]</sup> | 346<br>XXXX                    |

[1] Max peak reflow temperature of 235 °C

[2] Max peak reflow temperature of 260 °C

[3] 4-Digit lot number XXXX

Information furnished by Analog Devices is believed to be accurate and reliable. However, no responsibility is assumed by Analog Devices for its use, nor for any infringements of patents or other rights of third parties that may result from its use. Specifications subject to change without notice. No license is granted by implication or otherwise under any patent or patent rights of Analog Devices. Trademarks and registered trademarks are the property of their respective owners.

For price, delivery, and to place orders: Analog Devices, Inc., One Technology Way, P.O. Box 9106, Norwood, MA 02062-9106  
Phone: 781-329-4700 • Order online at [www.analog.com](http://www.analog.com)  
Application Support: Phone: 1-800-ANALOG-D



**GaAs MMIC VOLTAGE-VARIABLE ATTENUATOR, DC - 14 GHz**

**Pin Descriptions**

| Pin Number           | Function   | Description   | Interface Schematic |
|----------------------|------------|---|---------------------|
| 1, 3, 7, 10, 12      | GND        | Package bottom has exposed metal paddle that must also be connected to PCB RF ground.                                       |                     |
| 2, 11                | RF1<br>RF2 | This pin is DC coupled and matched to 50 Ohm. Blocking capacitors are required if the RF line potential is not equal to 0V. |                     |
| 4, 9, 13, 14, 15, 16 | N/C        | This pin should be connected to PCB RF ground.  |                     |
| 5, 8                 | V2, V1     | Control input (master).   |                     |
| 6                    | I          | Control input (slave).  |                     |

**Single-Line Control Driver**

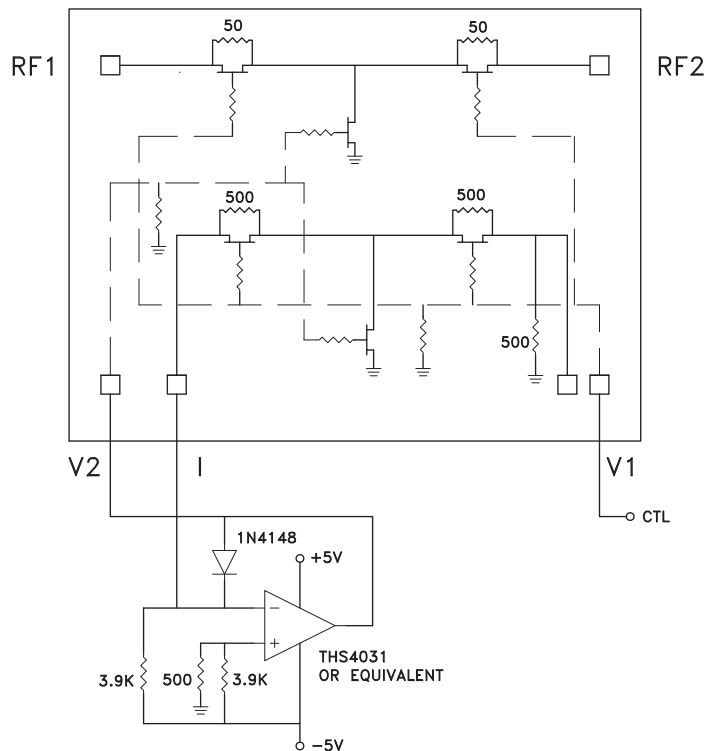

External op-amp control circuit maintains impedance match while attenuation is varied. Input control ranges from 0 Volts (min. attenuation) to -3.0 Volts (max. attenuation.)

Information furnished by Analog Devices is believed to be accurate and reliable. However, no responsibility is assumed by Analog Devices for its use, nor for any infringements of patents or other rights of third parties that may result from its use. Specifications subject to change without notice. No license is granted by implication or otherwise under any patent or patent rights of Analog Devices. Trademarks and registered trademarks are the property of their respective owners.

For price, delivery, and to place orders: Analog Devices, Inc., One Technology Way, P.O. Box 9106, Norwood, MA 02062-9106 Phone: 781-329-4700 • Order online at [www.analog.com](http://www.analog.com) Application Support: Phone: 1-800-ANALOG-D



**Evaluation PCB**

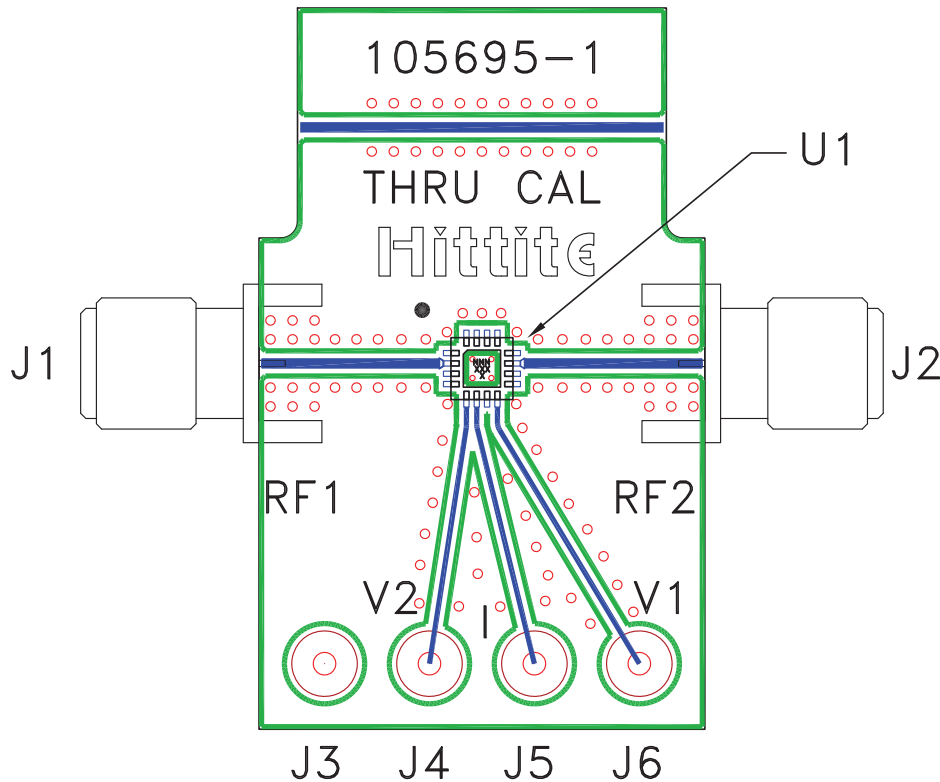

**List of Materials for Evaluation PCB 105709 [1]**

| Item    | Description                |
|---------|----------------------------|
| J1 - J2 | PCB Mount SMA RF Connector |
| J3 - J6 | DC Pin                     |
| U1      | HMC346LP3 / HMC346LP3E VVA |
| PCB [2] | 105695 Evaluation PCB      |

[1] Reference this number when ordering complete evaluation PCB

[2] Circuit Board Material: Rogers 4350

The circuit board used in the final application should be generated with proper RF circuit design techniques. Signal lines at the RF ports should be 50 ohm impedance and the package ground leads and package bottom should be connected directly to the PCB RF ground plane, similar to that shown above. The evaluation circuit board shown above is available from Hittite Microwave Corporation upon request.