

S71VS/XS-R Memory Subsystem Solutions

**MirrorBit® 1.8 Volt-Only Simultaneous Read/Write,
Burst Mode Multiplexed Flash Memory and Burst Mode
pSRAM**

**256/128/64 Mb (16/8/4 Mb x 16-bit) Flash,
128/64/32 Mb (8/4/2 Mb x 16-bit) pSRAM**

Data Sheet



Notice to Readers: This document states the current technical specifications regarding the Spansion product(s) described herein. Each product described herein may be designated as Advance Information, Preliminary, or Full Production. See [Notice On Data Sheet Designations](#) for definitions.

Notice On Data Sheet Designations

Spansion Inc. issues data sheets with Advance Information or Preliminary designations to advise readers of product information or intended specifications throughout the product life cycle, including development, qualification, initial production, and full production. In all cases, however, readers are encouraged to verify that they have the latest information before finalizing their design. The following descriptions of Spansion data sheet designations are presented here to highlight their presence and definitions.

Advance Information

The Advance Information designation indicates that Spansion Inc. is developing one or more specific products, but has not committed any design to production. Information presented in a document with this designation is likely to change, and in some cases, development on the product may discontinue. Spansion Inc. therefore places the following conditions upon Advance Information content:

“This document contains information on one or more products under development at Spansion Inc. The information is intended to help you evaluate this product. Do not design in this product without contacting the factory. Spansion Inc. reserves the right to change or discontinue work on this proposed product without notice.”

Preliminary

The Preliminary designation indicates that the product development has progressed such that a commitment to production has taken place. This designation covers several aspects of the product life cycle, including product qualification, initial production, and the subsequent phases in the manufacturing process that occur before full production is achieved. Changes to the technical specifications presented in a Preliminary document should be expected while keeping these aspects of production under consideration. Spansion places the following conditions upon Preliminary content:

“This document states the current technical specifications regarding the Spansion product(s) described herein. The Preliminary status of this document indicates that product qualification has been completed, and that initial production has begun. Due to the phases of the manufacturing process that require maintaining efficiency and quality, this document may be revised by subsequent versions or modifications due to changes in technical specifications.”

Combination

Some data sheets contain a combination of products with different designations (Advance Information, Preliminary, or Full Production). This type of document distinguishes these products and their designations wherever necessary, typically on the first page, the ordering information page, and pages with the DC Characteristics table and the AC Erase and Program table (in the table notes). The disclaimer on the first page refers the reader to the notice on this page.

Full Production (No Designation on Document)

When a product has been in production for a period of time such that no changes or only nominal changes are expected, the Preliminary designation is removed from the data sheet. Nominal changes may include those affecting the number of ordering part numbers available, such as the addition or deletion of a speed option, temperature range, package type, or V_{IO} range. Changes may also include those needed to clarify a description or to correct a typographical error or incorrect specification. Spansion Inc. applies the following conditions to documents in this category:

“This document states the current technical specifications regarding the Spansion product(s) described herein. Spansion Inc. deems the products to have been in sufficient production volume such that subsequent versions of this document are not expected to change. However, typographical or specification corrections, or modifications to the valid combinations offered may occur.”

Questions regarding these document designations may be directed to your local sales office.

S71VS/XS-R Memory Subsystem Solutions

MirrorBit® 1.8 Volt-Only Simultaneous Read/Write, Burst Mode Multiplexed Flash Memory and Burst Mode pSRAM

256/128/64 Mb (16/8/4 Mb x 16-bit) Flash,
128/64/32 Mb (8/4/2 Mb x 16-bit) pSRAM



Data Sheet

Features

- Power supply voltage of 1.7V to 1.95V
- Flash / pSRAM Burst Speed: 108 MHz, 104 MHz, 83 MHz
- MCP BGA Packages
 - 52 ball, 6.0 x 5.0 mm, 0.5 mm ball pitch
 - 56 ball, 7.7 x 6.2 mm, 0.5 mm ball pitch
 - 56 ball, 9.2 x 8.0 mm, 0.5 mm ball pitch
- Operating Temperature
 - Wireless, -25°C to +85°C
 - Industrial, -40°C to +85°C

General Description

The S71VS-R Series is a product line of stacked Multi-Chip Package (MCP) memory solutions and consists of the following items:

- One or more S29VS-R Flash memory die
- One or more pSRAM

The products covered by this document are listed in the table below. For details about their specifications, please refer to their individual data sheet for further details.

Flash Density	pSRAM Density	Product
64 Mb	32 Mb	S71VS064RB0
128 Mb	32 Mb	S71VS128RB0
128 Mb	64 Mb	S71VS128RC0
256 Mb	64 Mb	S71VS256RC0
256 Mb	128 Mb	S71VS256RD0

For detailed specifications, please refer to the individual data sheets:

Document	Publication Identification Number
S29VS/XS-R	S29VS_XS-R_00
S29VS/XS-R Supplement	S29VS_XS-R_SP
S29VS064R/XS064R	S29VS_XS064R_00
S29VS064R/XS064R Supplement	S29VS064R_XS064R_SP
128 Mb MUX pSRAM Type 5	pSRAM_39
32 Mb CellularRAM Address/Data multiplexed	SWM032D108M1R
32 Mb CellularRAM Address/Data multiplexed	SWM032D108M3R
64 Mb CellularRAM Address/Data multiplexed	SWM064D108M1R
128 Mb CellularRAM Address/Data multiplexed	SWM128D108M1R
128 Mb CellularRAM Address/Data multiplexed	SWM128D108M3R

1. Ordering Information

The order number is formed by a valid combinations of the following:

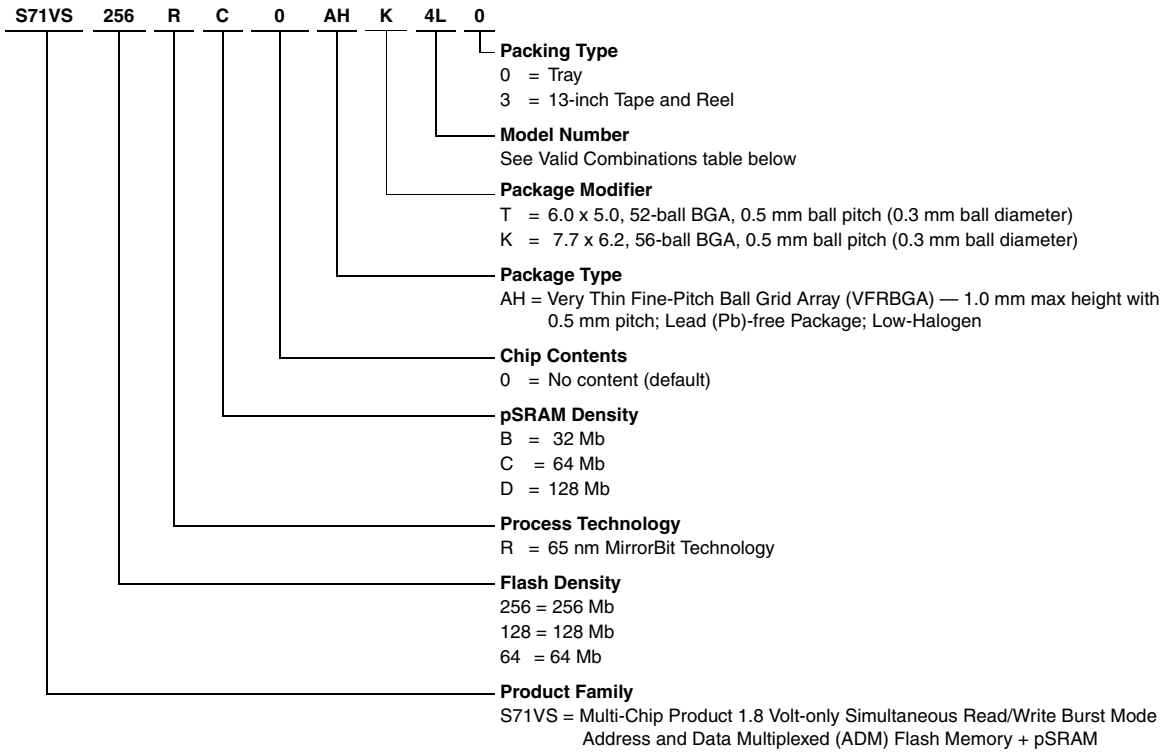

1.1 Valid Combinations

Valid Combinations list configurations planned to be supported in volume for this device. Consult your local sales office to confirm availability of specific valid combinations and to check on newly released combinations.

Base Ordering Part Number	Package	Model Number	Packing Type	pSRAM Type	Flash Boot	Temperature Range	Flash / pSRAM Speed	Pinout and Package Notes	
S71VS064RB0	AHT	0L	0, 3	SWM032D108M1R	Top	Wireless	108 MHz	Pinout: S71VS-R 52-ball Package: RSE052	
		8L			Bottom			Pinout: S71VS-R 52-ball Package: RLG052	
		3L			Top			Pinout: S71VS-R 52-ball Package: RSE052	
		BL			Bottom				
		4L			Top				
		CL			Bottom				
		0M		SWM032D108M3R	Top	Industrial		Pinout: S71VS-R 52-ball Package: RLG052	
		8M			Bottom				
		3M			Top				
		BM			Bottom				
S71VS128RB0	AHK	0L	0, 3	SWM032D108M1R	Top	Wireless	108 MHz	Pinout: S71VS-R 56-ball Package: RLA056	
		8L			Bottom				
		3L			Top			Pinout: S71VS-R 56-ball Package: RSD056	
		BL			Bottom				
		4L			Top				
S71VS128RC0	AHK	4L		SWM064D108M1R	Top		Wireless	108 MHz	Pinout: S71VS-R 56-ball Package: RSD056
		CL			Bottom				
S71VS256RC0	AHK	4L		SWM064D108M1R	Top		Wireless	108 MHz	Pinout: S71VS-R 56-ball Package: RLA056
		CL			Bottom				
S71VS256RD0	AHK	3L		0, 3	SWM128D108M1R		Top	Wireless	108 MHz
		BL	Bottom						
		3C	Top			83 MHz			
		BC	Bottom						
		3M	SWM128D108M3R		Top	Industrial	108 MHz		
		40			Bottom				
		C0	MUX pSRAM Type 5		Top	Wireless	108/104 MHz		
Bottom									

Note:
If a choice exists, Spansion recommends Top Boot.

2. Input/Output Descriptions

Table 2.1 identifies the input and output package connections provided on the device.

Table 2.1 Input/Output Descriptions

Symbol	Description	Flash	RAM
AMAX – A16	Address inputs.	X	X
A/DQ15-A/DQ0	Multiplexed Address/Data.	X	X
AVD#	Address Valid input. Indicates to device that the valid address is present on the address inputs. Low = for asynchronous mode, indicates valid address; for burst mode, causes starting address to be latched. High = device ignores address inputs	X	X
CLK	Clock input. In burst mode, after the initial word is output, subsequent active edges of CLK increment the internal address counter. Should be at V_{IL} or V_{IH} while in asynchronous mode.	X	X
DNU	Do Not Use. A device internal signal may be connected to the package connector. The connection may be used by Spansion for test or other purposes and is not intended for connection to any host system signal. Any DNU signal related function will be inactive when the signal is at V_{IL} . The signal has an internal pull-down resistor and may be left unconnected in the host system or may be tied to V_{SS} . Do not use these connections for PCB signal routing channels. Do not connect any host system signal to these connections.		
OE#	Output Enable input. Asynchronous relative to CLK for the Burst mode.	X	X
F-CE#	Chip-enable input for Flash. Asynchronous relative to CLK for Burst Mode.	X	
F-RDY/R-WAIT	Ready output; indicates the status of the Burst read. Flash Memory RDY (using default "Active HIGH" configuration) V_{OL} = data invalid V_{OH} = data valid Note: The default polarity for the pSRAM WAIT signal is opposite the default polarity of the Flash RDY signal. pSRAM WAIT (using default "Active HIGH" configuration) V_{OL} = data valid V_{OH} = data invalid To match polarities, change bit 10 of the pSRAM Bus Configuration Register to 0 (Active LOW WAIT). Alternately, change bit 10 of the Flash Configuration Register to 0 (Active LOW RDY).	X	X
F-RST#	Hardware reset input. Low = device resets and returns to reading array data	X	
F- V_{PP}	Accelerated input. At V_{HH} , accelerates programming; automatically places device in unlock bypass mode. At V_{IL} , disables all program and erase functions. Should be at V_{IH} for all other conditions.	X	
NC	Not Connected. No device internal signal is connected to the package connector nor is there any future plan to use the connector for a signal. The connection may safely be used for routing space for a signal on a Printed Circuit Board (PCB).		
R-CE#	Chip-enable input for pSRAM.		X
R-CRE	Control Register Enable (pSRAM).		X
R-LB#	Lower Byte Control (pSRAM).		X
R-UB#	Upper Byte Control (pSRAM).		X
RFU	Reserved For Future Use. No device internal signal is currently connected to the package connector but there is potential future use for the connector for a signal. It is recommended to not use RFU connectors for PCB routing channels so that the PCB may take advantage of future enhanced features in compatible footprint devices.		
V_{CC}	Flash and pSRAM 1.8 Volt-only single power supply.	X	X
V_{CCQ}	Flash and pSRAM Input/Output Power Supply.	X	X
V_{SS}	Ground.	X	X
V_{SSQ}	Input/Output Ground.	X	X
WE#	Write Enable input.	X	X

3. MCP Block Diagram

Figure 3.1 S71VS-R MCP Block Diagram

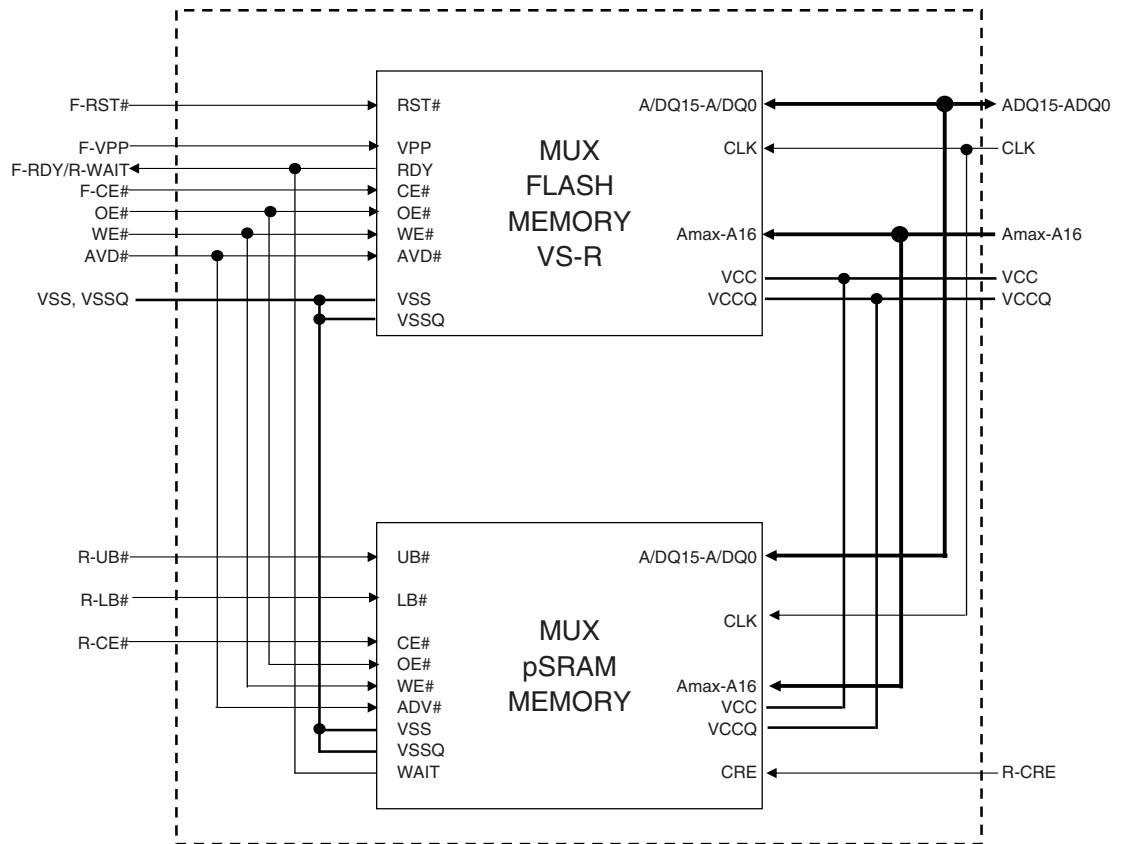

4. Connection Diagrams/Physical Dimensions

This section contains the I/O designations and package specifications for the S71VS-R.

4.1 Special Handling Instructions for FBGA Packages

Special handling is required for Flash Memory products in FBGA packages.

Flash memory devices in FBGA packages may be damaged if exposed to ultrasonic cleaning methods. The package and/or data integrity may be compromised if the package body is exposed to temperatures above 150°C for prolonged periods of time.

4.2 Connection Diagrams

Figure 4.1 S71VS-R 56-ball Fine-Pitch Ball Grid Array
(Top View, Balls Facing Down)

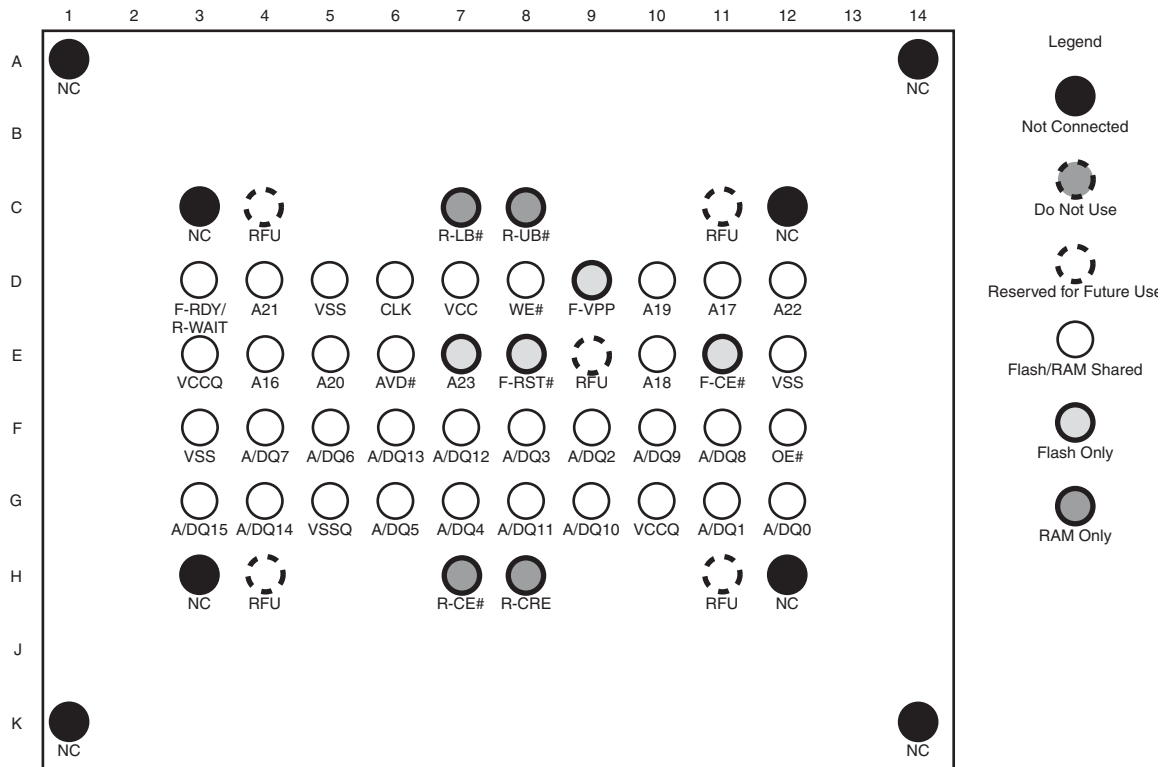
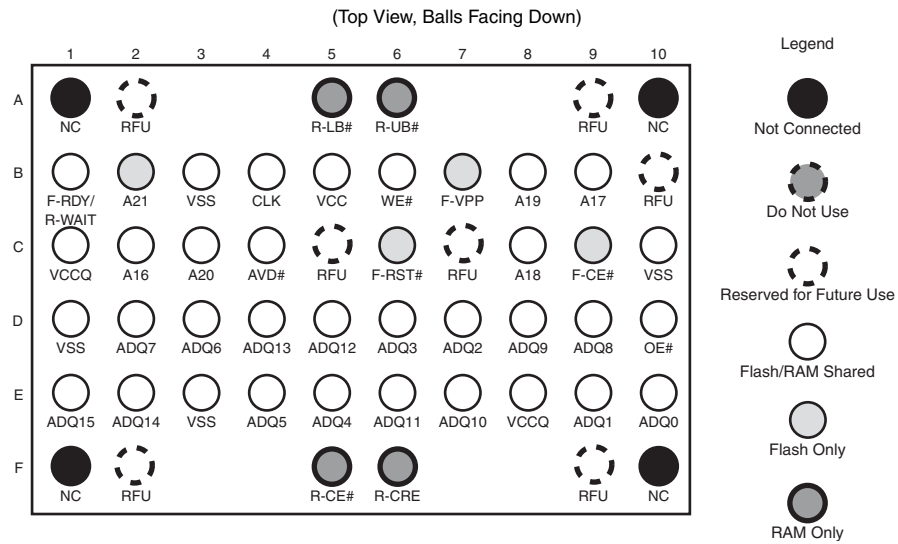

Figure 4.2 S71VS-R 52-ball Fine-Pitch Ball Grid Array



Notes:

1. Addresses are shared between Flash and RAM depending on the density of the pSRAM.
2. V_{SS} and V_{SSQ} must be connected together.

MCP	Flash-Only Addresses	Shared Addresses	Shared ADQ Pins
S71VS064RB0	A21	A20-A16	A/DQ15-A/DQ0
S71VS128RB0	A22-A21	A20-A16	
S71VS128RC0	A22	A21-A16	
S71VS256RC0	A23-A22	A21-A16	
S71VS256RD0	A23	A22-A16	

4.3 Physical Dimensions

Figure 4.3 RLG052 - 52-ball VFRBGA 6.0 x 5.0 mm

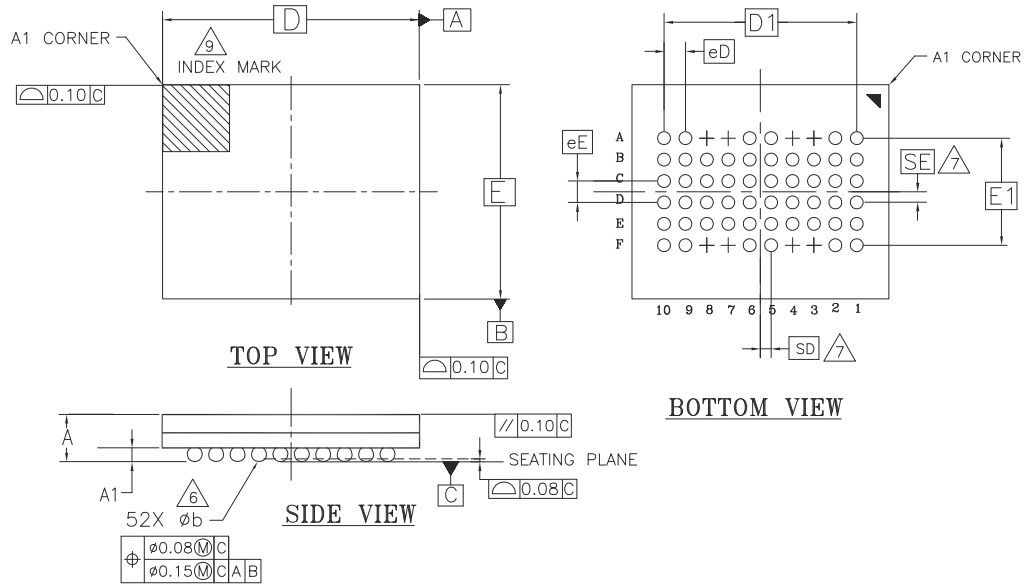

PACKAGE	RLG 052			
JEDEC	N/A			
	6.00 mm x 5.00 mm PACKAGE			
SYMBOL	MIN	NOM	MAX	NOTE
A	---	---	1.00	PROFILE
A1	0.18	---	---	BALL HEIGHT
D	6.00 BSC.			BODY SIZE
E	5.00 BSC.			BODY SIZE
D1	4.50 BSC.			MATRIX FOOTPRINT
E1	2.50 BSC.			MATRIX FOOTPRINT
MD	10			MATRIX SIZE D DIRECTION
ME	6			MATRIX SIZE E DIRECTION
n	52			BALL COUNT
phi b	0.25	0.30	0.35	BALL DIAMETER
e	0.50 BSC.			BALL PITCH
SE/SD	0.25 BSC.			SOLDER BALL PLACEMENT
	3A,3F,4A,4F,7A,7F,8A,8F			DEPOPULATED SOLDER BALLS

NOTES:

- DIMENSIONING AND TOLERANCING PER ASME Y14.5M-1994.
- ALL DIMENSIONS ARE IN MILLIMETERS.
- BALL POSITION DESIGNATION PER JEP 95, SECTION 4.3, SPP-010.
- e REPRESENTS THE SOLDER BALL GRID PITCH.
- SYMBOL "MD" IS THE BALL MATRIX SIZE IN THE "D" DIRECTION.
SYMBOL "ME" IS THE BALL MATRIX SIZE IN THE "E" DIRECTION.
n IS THE NUMBER OF POPULATED SOLDER BALL POSITIONS FOR MATRIX SIZE MD X ME
- 6 DIMENSION "b" IS MEASURED AT THE MAXIMUM BALL DIAMETER IN A PLANE PARALLEL TO DATUM C.
- 7 SD AND SE ARE MEASURED WITH RESPECT TO DATUMS A AND B AND DEFINE THE POSITION OF THE CENTER SOLDER BALL IN THE OUTER ROW.
WHEN THERE IS AN ODD NUMBER OF SOLDER BALLS IN THE OUTER ROW SD OR SE = 0.000.
WHEN THERE IS AN EVEN NUMBER OF SOLDER BALLS IN THE OUTER ROW, SD OR SE = e/2
- "+" INDICATES THE THEORETICAL CENTER OF DEPOPULATED BALLS.
- 9 A1 CORNER TO BE IDENTIFIED BY CHAMFER, LASER OR INK MARK, METALLIZED MARK INDENTATION OR OTHER MEANS.

g1002-1 | f16-038.63 | 08.25.10

Figure 4.4 RLA056 - 56-ball VFRBGA 7.7 x 6.2 mm

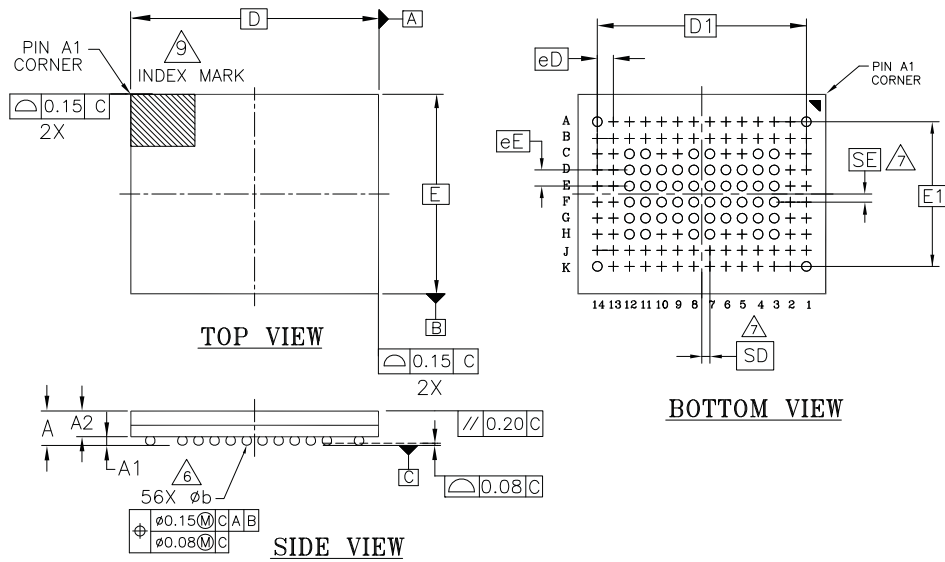

PACKAGE	RLA 056			NOTE
JEDEC	N/A			
D X E	7.70 mm x 6.20 mm PACKAGE			
SYMBOL	MIN	NOM	MAX	NOTE
A	---	---	1.00	PROFILE
A1	0.18	---	---	BALL HEIGHT
A2	0.62	---	0.74	BODY THICKNESS
D	7.70 BSC.			BODY SIZE
E	6.20 BSC.			BODY SIZE
D1	6.50 BSC.			MATRIX FOOTPRINT
E1	4.50 BSC.			MATRIX FOOTPRINT
MD	14			MATRIX SIZE D DIRECTION
ME	10			MATRIX SIZE E DIRECTION
n	56			BALL COUNT
b	0.25	0.30	0.35	BALL DIAMETER
eE	0.50 BSC.			BALL PITCH
eD	0.50 BSC.			BALL PITCH
SE SD	0.25 BSC.			SOLDER BALL PLACEMENT
	A2~A9, B1~B10, C1,C2, C9,C10,D1,D2,D9,D10, E1,E2,E3,E8,E9,E10,F1,F2, F3,F8,F9,F10,G1,G2,G9,G10, H1,H2,H9,H10,J1,J2,J3,J8,J9, J10,K1,K2,K3,K8,K9,K10, L1,L2,L9,L10,M1,M2,M9,M10, N1~N10, P2~P9			DEPOPULATED SOLDER BALLS

NOTES:

1. DIMENSIONING AND TOLERANCING PER ASME Y14.5M-1994.
2. ALL DIMENSIONS ARE IN MILLIMETERS.
3. BALL POSITION DESIGNATION PER JEP 95, SECTION 4.3, SPP-010.
4. e REPRESENTS THE SOLDER BALL GRID PITCH.

5. SYMBOL "MD" IS THE BALL MATRIX SIZE IN THE "D" DIRECTION.

SYMBOL "ME" IS THE BALL MATRIX SIZE IN THE "E" DIRECTION.

n IS THE NUMBER OF POPULATED SOLDER BALL POSITIONS FOR MATRIX SIZE MD X E

Δ DIMENSION "b" IS MEASURED AT THE MAXIMUM BALL DIAMETER IN A PLANE PARALLEL TO DATUM C.

Δ SD AND SE ARE MEASURED WITH RESPECT TO DATUMS A AND B AND DEFINE THE POSITION OF THE CENTER SOLDER BALL IN THE OUTER ROW.

WHEN THERE IS AN ODD NUMBER OF SOLDER BALLS IN THE OUTER ROW, SD OR SE = 0.000.

WHEN THERE IS AN EVEN NUMBER OF SOLDER BALLS IN THE OUTER ROW, SD OR SE = $e/2$

8. "+" INDICATES THE THEORETICAL CENTER OF DEPOPULATED BALLS.

Δ A1 CORNER TO BE IDENTIFIED BY CHAMFER, LASER OR INK MARK, METALLIZED MARK INDENTATION OR OTHER MEANS.

10. OUTLINE AND DIMENSIONS PER CUSTOMER REQUIREMENT.

g1007\1f16-038.63\08.18.10

Figure 4.5 RSD056—56-ball VFRBGA 7.7 x 6.2 mm

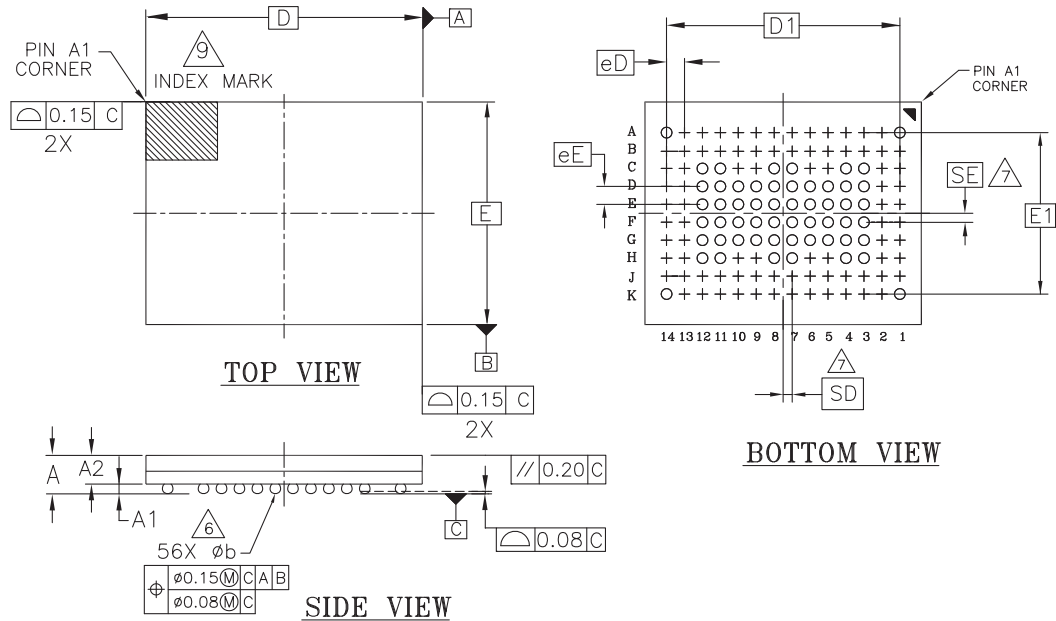

PACKAGE	RSD 056			NOTE
JEDEC	N/A			
D x E	7.70 mm x 6.20 mm PACKAGE			
SYMBOL	MIN	NOM	MAX	
A	0.80	0.90	1.00	PROFILE
A1	0.18	---	---	BALL HEIGHT
A2	0.62	---	0.74	BODY THICKNESS
D	7.70 BSC			BODY SIZE
E	6.20 BSC			BODY SIZE
D1	6.50 BSC			MATRIX FOOTPRINT
E1	4.50 BSC			MATRIX FOOTPRINT
MD	14			MATRIX SIZE D DIRECTION
ME	10			MATRIX SIZE E DIRECTION
n	56			BALL COUNT
ϕb	0.25	0.30	0.35	BALL DIAMETER
eE	0.50 BSC			BALL PITCH
eD	0.50 BSC			BALL PITCH
SE SD	0.25 BSC			SOLDER BALL PLACEMENT
	<small>A2~A9, B1~B10, C1,C2,C9,10,D1,D2,D9,D10 E1,E2,E3,E8,E9,E10,F1,F2,F3,F9,F10,G1,G2,G9,G10 H1,H2,H9,H10,I1,I2,I3,I8,I9,I10,K1,K2,K3,K8,K9,K10 L1,L2,L9,L10,M1,M2,M9,M10, N1~N10, P2~P9</small>			DEPOPULATED SOLDER BALLS

NOTES:

- DIMENSIONING AND TOLERANCING METHODS PER ASME Y14.5M-1994.
- ALL DIMENSIONS ARE IN MILLIMETERS.
- BALL POSITION DESIGNATION PER JEP95, SECTION 4.3, SPP-010.
- [e] REPRESENTS THE SOLDER BALL GRID PITCH.
- SYMBOL "MD" IS THE BALL MATRIX SIZE IN THE "D" DIRECTION.
SYMBOL "ME" IS THE BALL MATRIX SIZE IN THE "E" DIRECTION.
n IS THE NUMBER OF POPULATED SOLDER BALL POSITIONS FOR MATRIX SIZE MD X ME.
- DIMENSION "b" IS MEASURED AT THE MAXIMUM BALL DIAMETER IN A PLANE PARALLEL TO DATUM C.
SD AND SE ARE MEASURED WITH RESPECT TO DATUMS A AND B AND DEFINE THE POSITION OF THE CENTER SOLDER BALL IN THE OUTER ROW.
- WHEN THERE IS AN ODD NUMBER OF SOLDER BALLS IN THE OUTER ROW SD OR SE = 0.000.
WHEN THERE IS AN EVEN NUMBER OF SOLDER BALLS IN THE OUTER ROW, SD OR SE = [e/2]
- "+" INDICATES THE THEORETICAL CENTER OF DEPOPULATED BALLS.
- A1 CORNER TO BE IDENTIFIED BY CHAMFER, LASER OR INK MARK, METALLIZED MARK INDENTATION OR OTHER MEANS.
- OUTLINE AND DIMENSIONS PER CUSTOMER REQUIREMENT.

3719 1116-038.63 \ 1.26.9

Figure 4.6 RSE052—52-ball VFRBGA 6.0 x 5.0 mm

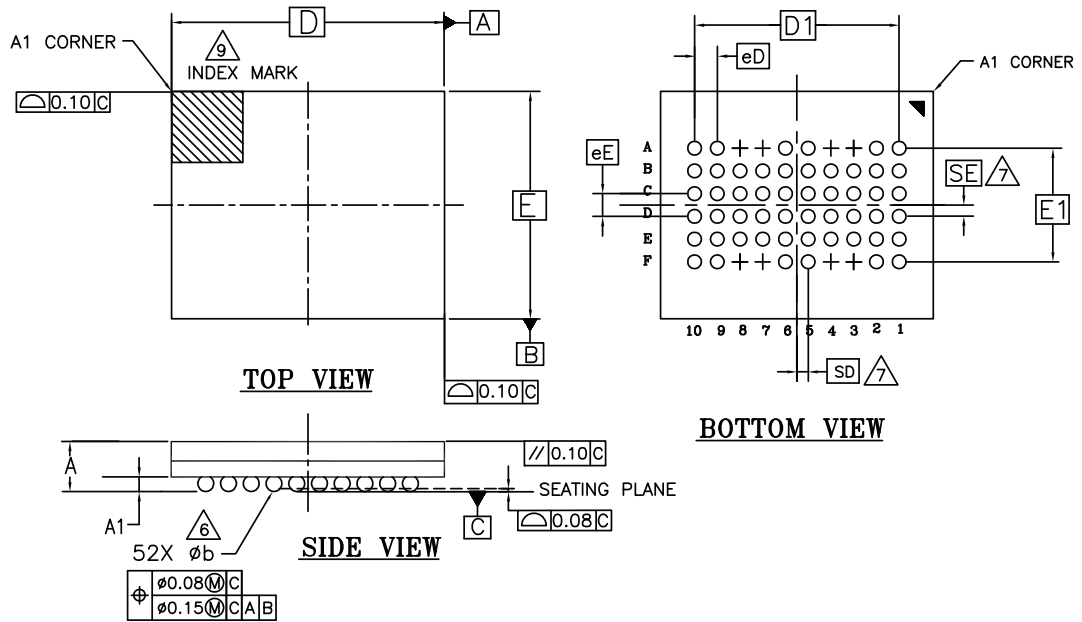

PACKAGE	RSE 052			
JEDEC	N/A			
D X E	6.00 mm x 5.00 mm PACKAGE			
SYMBOL	MIN	NOM	MAX	NOTE
A	---	---	1.00	PROFILE
A1	0.18	---	---	BALL HEIGHT
D	6.00 BSC.			BODY SIZE
E	5.00 BSC.			BODY SIZE
D1	4.50 BSC.			MATRIX FOOTPRINT
E1	2.50 BSC.			MATRIX FOOTPRINT
MD	10			MATRIX SIZE D DIRECTION
ME	6			MATRIX SIZE E DIRECTION
n	52			BALL COUNT
b	0.25	0.30	0.35	BALL DIAMETER
e	0.50 BSC.			BALL PITCH
SE/SD	0.25 BSC.			SOLDER BALL PLACEMENT
	3A,3F,4A,4F,7A,7F,8A,8F			DEPOPULATED SOLDER BALLS

NOTES:

- DIMENSIONING AND TOLERANCING PER ASME Y14.5M-1994.
- ALL DIMENSIONS ARE IN MILLIMETERS.
- BALL POSITION DESIGNATION PER JEP 95, SECTION 4.3, SPP-010.
- [e] REPRESENTS THE SOLDER BALL GRID PITCH.
- SYMBOL "MD" IS THE BALL MATRIX SIZE IN THE "D" DIRECTION.
SYMBOL "ME" IS THE BALL MATRIX SIZE IN THE "E" DIRECTION.
n IS THE NUMBER OF POPULATED SOLDER BALL POSITIONS FOR MATRIX SIZE MD X ME
- [6] DIMENSION "b" IS MEASURED AT THE MAXIMUM BALL DIAMETER IN A PLANE PARALLEL TO DATUM C.
- [7] SD AND SE ARE MEASURED WITH RESPECT TO DATUMS A AND B AND DEFINE THE POSITION OF THE CENTER SOLDER BALL IN THE OUTER ROW.
WHEN THERE IS AN ODD NUMBER OF SOLDER BALLS IN THE OUTER ROW SD OR SE = 0.000.
WHEN THERE IS AN EVEN NUMBER OF SOLDER BALLS IN THE OUTER ROW, SD OR SE = [e/2]
- "+" INDICATES THE THEORETICAL CENTER OF DEPOPULATED BALLS.
- [9] A1 CORNER TO BE IDENTIFIED BY CHAMFER, LASER OR INK MARK, METALLIZED MARK INDENTATION OR OTHER MEANS.

g1004-1\116-038.63\08.25.10

5. Revision History

Section	Description
Revision 01 (August 25, 2008)	
	Initial release
Revision 02 (November 4, 2008)	
Global	Added OPNs S71VS064RB0AHT00/04/80/84
Connection Diagrams	Added S71VS-R 52-ball connection diagram
Physical Dimensions	Added RSB052
General Description	Changed 128 Mb Mux pSRAM PID from TBD to pSRAM_39
Revision 03 (November 10, 2008)	
General Description	Changed 64 Mb MUX pSRAM Type 3 PID from muxpsram_14 to muxpsram_15
Revision 04 (January 13, 2009)	
Physical Dimensions	Replaced NLD056 with NSD056
Revision 05 (January 23, 2009)	
Valid Combinations	Added OPN S71VS128RC0AHK20
Physical Dimensions	Added RSD056
Revision 06 (March 11, 2009)	
Valid Combinations	Added 108 MHz speed grade to S71VS128RC0 and S71VS256RC0
Revision 07 (September 29, 2009)	
General Description	Added S71VS128RB0; added muxpsram_10
Valid Combinations	Added OPN S71VS128RB0
Revision 08 (April 9, 2010)	
General Description	Added SWM064D108M1R Updated pSRAM documentation names
Valid Combinations	Added OPNs: S71VS128RC0AHK4L S71VS256RC0AHK4L Removed Bottom Boot options
Connection Diagrams	Updated V _{SSQ} ball to V _{SS}
Revision 09 (May 4, 2010)	
General Description	Added reference to S29VS064R data sheet Removed CustComspec_01 for 32 Mb MUX pSRAM
Valid Combinations	Corrected pSRAM type for S71VS064RB0 from CustComspec_01 to SWM032D108M1R Added OPNs: S71VS064RB0AHT0L S71VS256RD0AHK40
Revision 10 (June 14, 2010)	
General Description	Removed S71XS256RD0 from table Unified data sheet reference for S29VS/XS-R Removed MUX pSRAM Type 3 Added SWM128D108M1R
Valid Combinations	Restored necessary bottom boot options. Added OPNs: S71VS256RD0AHK3L/BL/3C/BC Removed OPNs: S71VS064RB0AHT00/04 Updated MUX pSRAM Type 3 entries to the Common RAM type specifications Removed table after Figure 4.3 S71XS-R 56-ball Fine-Pitch Ball Grid Array

Section	Description
Revision 11 (July 28, 2010)	
Features	Corrected MCP BGA Packages information
Ordering Information	Corrected Package Modifier information Removed 7 inch Tape and Reel option
Valid Combinations	Corrected package information for S71VS064RB0AHT0L Added OPN S71VS064RB0AHT8L, S71VS128RC0AHKCL, S71VS256RC0AHKCL Removed OPN S71VS256RD0AHK40
MCP Block Diagram	Removed figure S71XS-R MCP Block Diagram
Connection Diagrams/Physical Dimensions	Corrected figure S71VS-R 52-ball Fine-Pitch Ball Grid Array Removed figure S71XS-R 56-ball Fine-Pitch Ball Grid Array Replaced figure RSB052—52-ball VFBGA 5.0 x 7.5 mm with RSE052—52-ball VFRBGA 6.0 x 5.0 mm Refreshed DNU/RFU/NC definitions
Revision 12 (August 27, 2010)	
Valid Combinations	Corrected package information for S71VS128RB0AHK0L/8L (RLA056) Corrected speed for OPNs S71VS256RD0AHK3L/BL to 108 MHz
Connection Diagrams	Reverted DNU balls to RFU
Physical Dimensions	Added diagram for RLA056
Revision 13 (December 9, 2010)	
Features	Added Industrial temperature
General Description	Added references to S29VS_XS-R_SP, S29VS064R_XS064R_SP, SWM032D108M3R, SWM128D108M3R
Valid Combinations	Added OPNs S71VS064RB0AHT3L/BL/0M/8M, S71VS128RB0AHK3L/BL, S71VS256RD0AHK3M, S71VS256RD0AHK40/C0 Added Temperature Range Column
Revision 14 (April 13, 2011)	
General Description	Removed SWM032D108M1N and SWM064D108M1N references
Valid Combinations	Removed OPNs S71VS064RB0AHT3M/BM, S71VS128RB0AHK2L/AL, S71VS128RC0AHK20, S71VS128RC0ZHKxx, S71VS256RC0ZHKxx, S71VS256RD0ZHExx Physical Dimensions: Removed NLB056 and NSD056 diagrams. Added diagram for RLG052
Revision 15 (June 20, 2011)	
Valid Combinations	Added OPNs S71VS128RB0AHK4L/CL, , S71VS064RB0AHT4L/CL
Revision 16 (June 29, 2012)	
Valid Combinations	Added OPNs S71VS064RB0AHT3M/BM
Revision 17 (October 2, 2012)	
Valid Combinations	Updated the S71VS256RC0AHK4L/CL package from RSD056 to RLA056

Colophon

The products described in this document are designed, developed and manufactured as contemplated for general use, including without limitation, ordinary industrial use, general office use, personal use, and household use, but are not designed, developed and manufactured as contemplated (1) for any use that includes fatal risks or dangers that, unless extremely high safety is secured, could have a serious effect to the public, and could lead directly to death, personal injury, severe physical damage or other loss (i.e., nuclear reaction control in nuclear facility, aircraft flight control, air traffic control, mass transport control, medical life support system, missile launch control in weapon system), or (2) for any use where chance of failure is intolerable (i.e., submersible repeater and artificial satellite). Please note that Spansion will not be liable to you and/or any third party for any claims or damages arising in connection with above-mentioned uses of the products. Any semiconductor devices have an inherent chance of failure. You must protect against injury, damage or loss from such failures by incorporating safety design measures into your facility and equipment such as redundancy, fire protection, and prevention of over-current levels and other abnormal operating conditions. If any products described in this document represent goods or technologies subject to certain restrictions on export under the Foreign Exchange and Foreign Trade Law of Japan, the US Export Administration Regulations or the applicable laws of any other country, the prior authorization by the respective government entity will be required for export of those products.

Trademarks and Notice

The contents of this document are subject to change without notice. This document may contain information on a Spansion product under development by Spansion. Spansion reserves the right to change or discontinue work on any product without notice. The information in this document is provided as is without warranty or guarantee of any kind as to its accuracy, completeness, operability, fitness for particular purpose, merchantability, non-infringement of third-party rights, or any other warranty, express, implied, or statutory. Spansion assumes no liability for any damages of any kind arising out of the use of the information in this document.

Copyright © 2008-2012 Spansion Inc. All rights reserved. Spansion®, the Spansion Logo, MirrorBit®, MirrorBit® Eclipse™, ORNAND™ and combinations thereof, are trademarks and registered trademarks of Spansion LLC in the United States and other countries. Other names used are for informational purposes only and may be trademarks of their respective owners.