

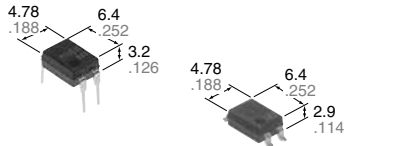

**Normally closed type
with reinforced insulation**

**PhotoMOS®
GE 1 Form B
(AQY410EH)**



mm inch

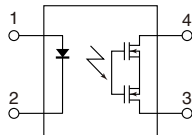

RoHS compliant

FEATURES

1. 1 Form B output type
2. Low on-resistance
 This has been realized thanks to the built-in MOSFET processed by our proprietary method, DSD (Double-diffused and Selective Doping) method.

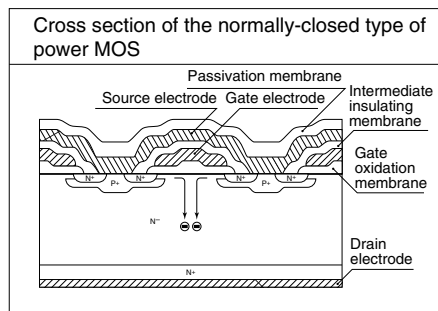

3. Reinforced insulation of 5,000 V
 More than 0.4 mm internal insulation distance between inputs and outputs. Conforms to EN41003, EN60950 (reinforced insulation).

4. Controls low-level analog signals
 PhotoMOS feature extremely low closed-circuit offset voltage to enable control of low-level analog signals without distortion.

5. High sensitivity and low on-resistance
 Can control max. 0.55 A load current with 5 mA input current. Low on-resistance of typ. 1Ω (AQY412EH).

6. Low-level off-state leakage current

TYPICAL APPLICATIONS

- Power supply
- Measuring equipment
- Security equipment
- Modem
- Telephone equipment
- Electricity, plant equipment
- Sensing equipment

TYPES

Type	I/O isolation voltage	Output rating*		Package	Part No.				Packing quantity	
					Through hole terminal	Surface-mount terminal		Tube packing style		
		Load voltage	Load current			AQY412EH	AQY412EHA		AQY412EHAX	AQY412EHAZ
AC/DC dual use	Reinforced 5,000 V	60 V	550 mA	DIP4-pin	AQY412EH	AQY412EHA	AQY412EHAX	AQY412EHAZ	1 tube contains: 100 pcs. 1 batch contains: 1,000 pcs.	1,000 pcs.
		350 V	130 mA		AQY410EH	AQY410EHA	AQY410EHAX	AQY410EHAZ		
		400 V	120 mA		AQY414EH	AQY414EHA	AQY414EHAX	AQY414EHAZ		

*Indicate the peak AC and DC values.
 Note: For space reasons, the initial letters of the part number "AQY", the surface mount terminal shape indicator "A" and the packing style indicator "X" or "Z" are not marked on the device. (Ex. the label for product number AQY412EHAX is 412EH.)

RATING

1. Absolute maximum ratings (Ambient temperature: 25°C 77°F)

Item	Symbol	AQY412EH(A)	AQY410EH(A)	AQY414EH(A)	Remarks	
Input	LED forward current	I _F	50 mA			
	LED reverse voltage	V _R	5 V			
	Peak forward current	I _{FP}	1 A		f = 100 Hz, Duty factor = 0.1%	
	Power dissipation	P _{in}	75 mW			
Output	Load voltage (peak AC)	V _L	60 V	350 V	400 V	
	Continuous load current	I _L	0.55 A	0.13 A	0.12 A	Peak AC, DC
	Peak load current	I _{peak}	1.5 A	0.4 A	0.3 A	100 ms (1 shot), V _L = DC
	Power dissipation	P _{out}	500 mW			
Total power dissipation	P _T	550 mW				
I/O isolation voltage	V _{iso}	5,000 V AC				
Temperature limits	Operating	T _{opr}	-40°C to +85°C -40°F to +185°F		Non-condensing at low temperatures	
	Storage	T _{stg}	-40°C to +100°C -40°F to +212°F			

GE 1 Form B (AQY41EH)

2. Electrical characteristics (Ambient temperature: 25°C 77°F)

Item		Symbol	AQY412EH(A)	AQY410EH(A)	AQY414EH(A)	Condition
Input	LED operate (OFF) current	Typical	1.4 mA			I _L =Max.
		Maximum	3.0 mA			
	LED reverse (ON) current	Minimum	0.4 mA			I _L =Max.
		Typical	1.3 mA			
LED dropout voltage	Typical	1.25 (1.14 V at I _F = 5 mA)			I _F = 50 mA	
	Maximum	1.5 V				
Output	On resistance	Typical	1Ω	18Ω	26Ω	I _F = 0 mA I _L = Max. Within 1 s on time
		Maximum	2.5Ω	25Ω	35Ω	
	Off state leakage current	Maximum	10μA			I _F = 5 mA V _L = Max.
Transfer characteristics	Operate (OFF) time*	Typical	3.0 ms	1.0 ms	0.8 ms	I _F = 0 mA → 5 mA I _L = Max.
		Maximum	10.0 ms	3.0 ms		
	Reverse (ON) time*	Typical	0.2 ms	0.3 ms	0.2 ms	I _F = 5 mA → 0 mA I _L = Max.
		Maximum	1.0 ms			
	I/O capacitance	Typical	0.8 pF			f = 1MHz V _B = 0 V
Maximum		1.5 pF				
Initial I/O isolation resistance	Minimum	R _{iso}	1,000MΩ		500 V DC	

*Operate/Reverse time

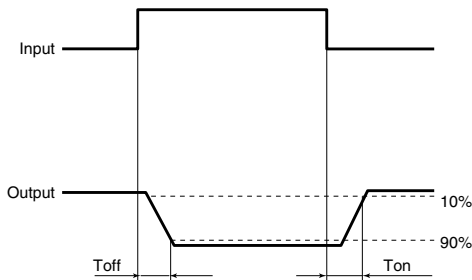

RECOMMENDED OPERATING CONDITIONS

Please obey the following conditions to ensure proper device operation and resetting.

Item	Symbol	Recommended value	Unit
Input LED current	I _F	5 to 10	mA

■ These products are not designed for automotive use.

If you are considering to use these products for automotive applications, please contact your local Panasonic Corporation technical representative.

REFERENCE DATA

1-(1). Load current vs. ambient temperature characteristics

Allowable ambient temperature: -40°C to +85°C
-40°F to +185°F

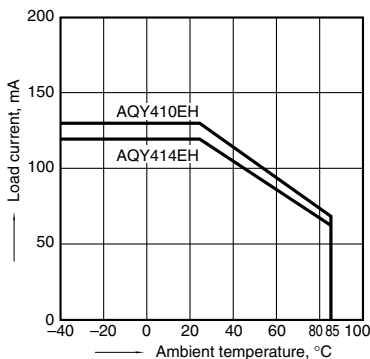

1-(2). Load current vs. ambient temperature characteristics

Allowable ambient temperature: -40°C to +85°C
-40°F to +185°F

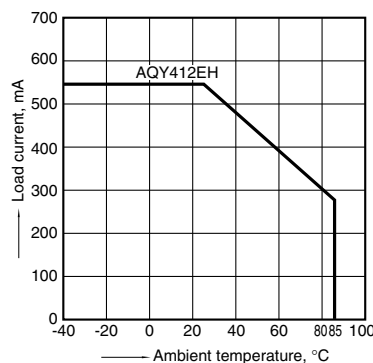

2. On resistance vs. ambient temperature characteristics

Measured portion: between terminals 3 and 4;
LED current: 0 mA; Load voltage: Max.(DC);
Continuous load current: Max. (DC)

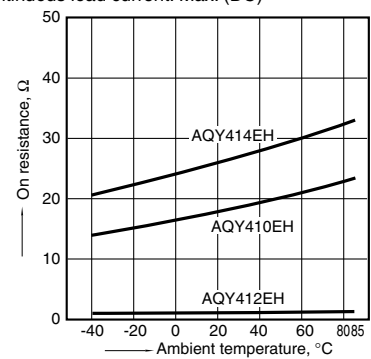

3. Operate (OFF) time vs. ambient temperature characteristics

LED current: 5 mA; Load voltage: Max. (DC);
Continuous load current: Max. (DC)

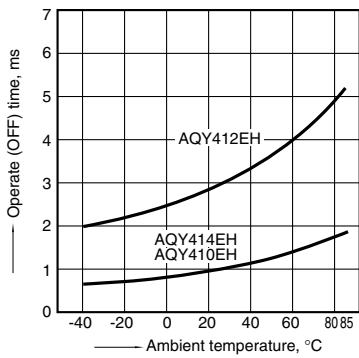

4. Reverse (ON) time vs. ambient temperature characteristics

LED current: 5 mA; Load voltage: Max. (DC);
Continuous load current: Max. (DC)

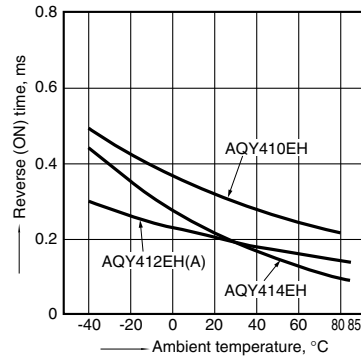

5. LED operate (OFF) current vs. ambient temperature characteristics

Sample: All types;
Load voltage: Max. (DC);
Continuous load current: Max. (DC)

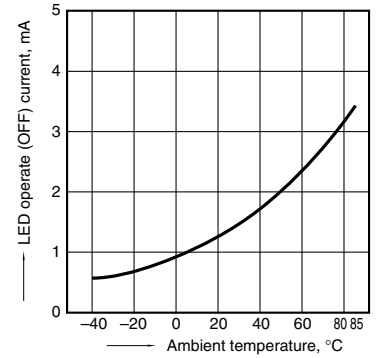

6. LED reverse (ON) current vs. ambient temperature characteristics

Sample: All types;
Load voltage: Max. (DC);
Continuous load current: Max. (DC)

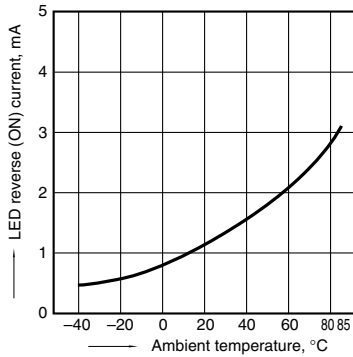

7. LED dropout voltage vs. ambient temperature characteristics

LED current: 5 to 50 mA

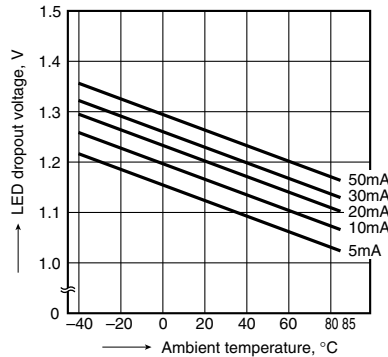

8-(1). Current vs. voltage characteristics of output at MOS portion

Measured portion: between terminals 3 and 4;
Ambient temperature: 25°C 77°F

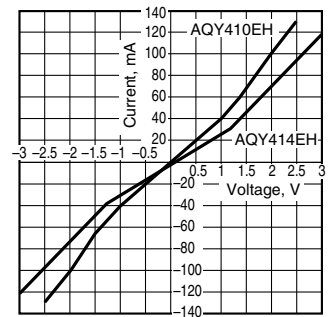

8-(2). Current vs. voltage characteristics of output at MOS portion

Measured portion: between terminals 3 and 4;
Ambient temperature: 25°C 77°F

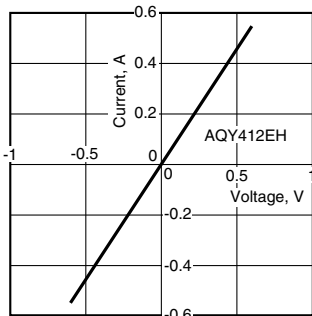

9. Off state leakage current vs. load voltage characteristics

Measured portion: between terminals 3 and 4;
Ambient temperature: 25°C 77°F

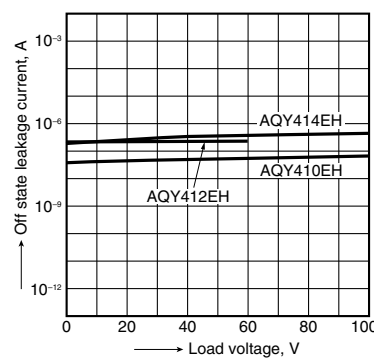

10. Operate (OFF) time vs. LED forward current characteristics

Measured portion: between terminals 3 and 4;
Load voltage: Max. (DC); Continuous load current: Max. (DC); Ambient temperature: 25°C 77°F

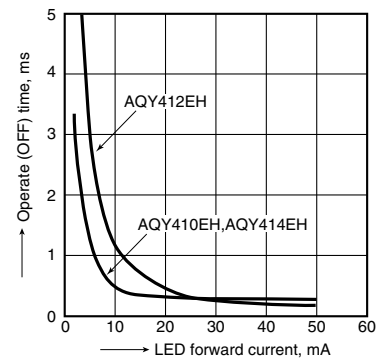

11. Reverse (ON) time vs. LED forward current characteristics

Measured portion: between terminals 3 and 4;
Load voltage: Max. (DC); Continuous load current: Max. (DC); Ambient temperature: 25°C 77°F

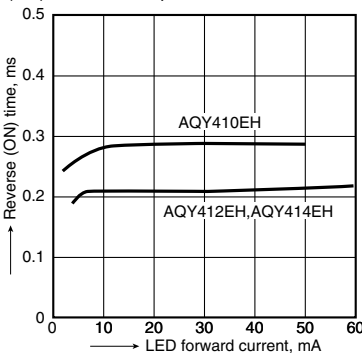

12. Output capacitance vs. applied voltage characteristics

Measured portion: between terminals 3 and 4;
Frequency: 1 MHz; Ambient temperature: 25°C 77°F

