

## 2.25MHz, 800mA Synchronous Step-Down Regulator in ThinSOT

### FEATURES

- **High Efficiency: Up to 95%**
- **Low Output Ripple (<20mV<sub>p-p</sub>): Burst Mode® Operation: I<sub>Q</sub> = 16μA**
- **2.5V to 5.5V Input Voltage Range**
- **2.25MHz Constant Frequency Operation**
- Synchronizable to External Clock
- No Schottky Diode Required
- Stable with Ceramic Capacitors
- Low Dropout Operation: 100% Duty Cycle
- 0.6V Reference Allows Low Output Voltages
- Shutdown Mode Draws <1μA Supply Current
- ±2% Output Voltage Accuracy
- Current Mode Operation for Excellent Line and Load Transient Response
- Overtemperature Protected
- Low Profile (1mm) ThinSOT™ Package

### APPLICATIONS

- Cellular Telephones
- Wireless and DSL Modems
- Digital Still Cameras
- Media Players
- Portable Instruments

### DESCRIPTION

The LTC®3560 is a high efficiency monolithic synchronous buck regulator using a constant frequency, current mode architecture. Supply current during operation is only 16μA, dropping to <1μA in shutdown. The 2.5V to 5.5V input voltage range makes the LTC3560 ideally suited for single Li-Ion/Li-Polymer battery-powered applications. 100% duty cycle provides low dropout operation, extending battery life in portable systems.

Switching frequency is internally set at 2.25MHz, allowing the use of small surface mount inductors and capacitors. For noise sensitive applications the LTC3560 can be externally synchronized from 1MHz to 3MHz. Burst Mode operation is inhibited during synchronization or when the SYNC/MODE pin is pulled high, preventing low frequency ripple from interfering with audio circuitry.

The internal synchronous switch increases efficiency and eliminates the need for an external Schottky diode. Low output voltages are easily supported with the 0.6V feedback reference voltage. The LTC3560 is available in a low profile (1mm) ThinSOT package.

LT, LT, LTC, LTM and Burst Mode are registered trademarks of Linear Technology Corporation. ThinSOT is a trademark of Linear Technology Corporation. All other trademarks are the property of their respective owners. Protected by U.S. Patents including 6580258, 5481178, 5994885, 6304066, 6498466, 6611131.

### TYPICAL APPLICATION

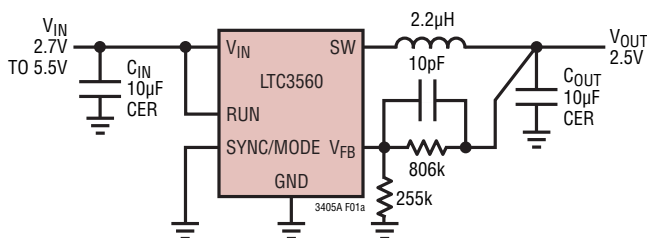

Figure 1a. High Efficiency Step-Down Converter

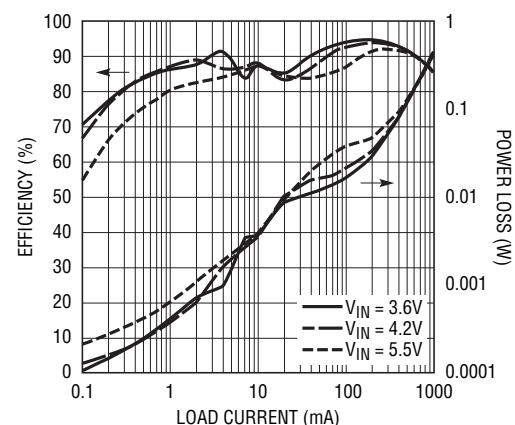

Figure 1b. Efficiency vs Load Current

## ABSOLUTE MAXIMUM RATINGS

(Note 1)

|  |                                   |
|--|-----------------------------------|
| Input Supply Voltage.....                          | -0.3V to 6V                       |
| SYNC/MODE, RUN, V <sub>FB</sub> Voltages.....      | -0.3V to V <sub>IN</sub>          |
| SW Voltage (DC).....                               | -0.3V to (V <sub>IN</sub> + 0.3V) |
| P-Channel Switch Source Current (DC) (Note 6)..... | 1.2A                              |
| N-Channel Switch Sink Current (DC) (Note 6).....   | 1.2A                              |
| Peak SW Sink and Source Current (Note 6).....      | 2.1A                              |
| Operating Temperature Range (Note 2)               |                                   |
| LTC3560E.....                                      | -40°C to 85°C                     |
| LTC3560I.....                                      | -40°C to 125°C                    |
| Junction Temperature (Notes 3, 7).....             | 125°C                             |
| Storage Temperature Range.....                     | -65°C to 150°C                    |
| Lead Temperature (Soldering, 10 sec).....          | 300°C                             |

## PIN CONFIGURATION

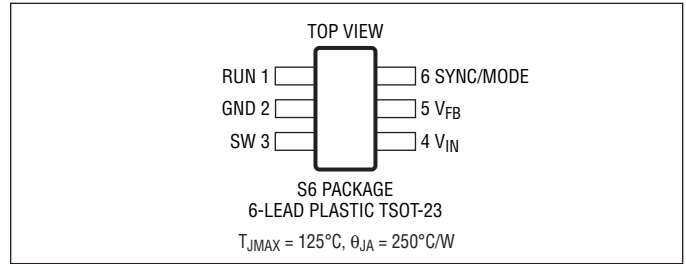

## ORDER INFORMATION

| LEAD FREE FINISH | TAPE AND REEL    | PART MARKING* | PACKAGE DESCRIPTION    | TEMPERATURE RANGE |
|------------------|------------------|---------------|------------------------|-------------------|
| LTC3560ES6#PBF   | LTC3560ES6#TRPBF | LTCFY         | 6-Lead Plastic TSOT-23 | -40°C to 85°C     |
| LTC3560IS6#PBF   | LTC3560IS6#TRPBF | LTCFY         | 6-Lead Plastic TSOT-23 | -40°C to 125°C    |

Consult LTC Marketing for parts specified with wider operating temperature ranges. \*The temperature grade is identified by a label on the shipping container. Consult LTC Marketing for information on non-standard lead based finish parts.

For more information on lead free part marking, go to: <http://www.linear.com/leadfree/>

For more information on tape and reel specifications, go to: <http://www.linear.com/tapeandreel/>

## ELECTRICAL CHARACTERISTICS

The ● denotes the specifications which apply over the full operating temperature range, otherwise specifications are at T<sub>A</sub> = 25°C. V<sub>IN</sub> = 3.6V unless otherwise specified.

| SYMBOL               | PARAMETER                            | CONDITIONS  | MIN    | TYP            | MAX          | UNITS          |            |
|----------------------|--------------------------------------|---|--------|----------------|--------------|----------------|------------|
| I <sub>VFB</sub>     | Feedback Current                     |   |        |                | ±30          | nA             |            |
| I <sub>PK</sub>      | Peak Inductor Current                | V <sub>IN</sub> = 3V, V <sub>FB</sub> = 0.5V, Duty Cycle < 35%              | 1.0    | 1.5            | 2.0          | A              |            |
| V <sub>FB</sub>      | Regulated Feedback Voltage           | (Note 4) E Grade<br>I Grade   | ●<br>● | 0.588<br>0.582 | 0.6<br>0.6   | 0.612<br>0.618 | V<br>V     |
| ΔV <sub>FB</sub>     | Reference Voltage Line Regulation    | V <sub>IN</sub> = 2.5V to 5.5V (Note 4) E Grade<br>I Grade                  | ●<br>● |                | 0.04<br>0.04 | 0.4<br>0.8     | %/V<br>%/V |
| V <sub>LOADREG</sub> | Output Voltage Load Regulation       |   |        | 0.5            |              | %              |            |
| V <sub>IN</sub>      | Input Voltage Range                  |   | ●      | 2.5            | 5.5          | V              |            |
| I <sub>S</sub>       | Input DC Bias Current                | (Note 5)  |        |                |              |                |            |
|                      | Pulse-Skipping Mode                  | V <sub>FB</sub> = 0.63V, Mode = High, I <sub>LOAD</sub> = 0A                |        | 200            | 300          | μA             |            |
|                      | Burst Mode Operation                 | V <sub>FB</sub> = 0.63V, Mode = Low, I <sub>LOAD</sub> = 0A                 |        | 16             | 30           | μA             |            |
|                      | Shutdown                             | V <sub>RUN</sub> = 0V, V <sub>IN</sub> = 5.5V                               |        | 0.1            | 1            | μA             |            |
| f <sub>OSC</sub>     | Oscillator Frequency                 | V <sub>FB</sub> = 0.6V  | ●      | 1.8            | 2.25         | 2.7            | MHz        |
| f <sub>SYNC</sub>    | SYNC Frequency Range                 |   | ●      | 1              |              | 3              | MHz        |
| R <sub>PFET</sub>    | R <sub>DS(ON)</sub> of P-Channel FET | I <sub>SW</sub> = 100mA   |        | 0.23           | 0.35         | Ω              |            |
| R <sub>NFET</sub>    | R <sub>DS(ON)</sub> of N-Channel FET | I <sub>SW</sub> = -100mA  |        | 0.21           | 0.35         | Ω              |            |
| I <sub>LSW</sub>     | SW Leakage                           | V <sub>RUN</sub> = 0V, V <sub>SW</sub> = 0V or 5.5V, V <sub>IN</sub> = 5.5V |        | ±0.01          | ±1           | μA             |            |

3560fb

**ELECTRICAL CHARACTERISTICS** The ● denotes the specifications which apply over the full operating temperature range, otherwise specifications are at  $T_A = 25^\circ\text{C}$ .  $V_{IN} = 3.6\text{V}$  unless otherwise specified.

| SYMBOL          | PARAMETER                 | CONDITIONS                          | MIN | TYP        | MAX     | UNITS         |
|-----------------|---------------------------|-------------------------------------|-----|------------|---------|---------------|
| $V_{RUN}$       | RUN Threshold             | ●                                   | 0.3 | 1          | 1.5     | V             |
| $I_{RUN}$       | RUN Leakage Current       | ●                                   |     | $\pm 0.01$ | $\pm 1$ | $\mu\text{A}$ |
| $V_{SYNC/MODE}$ | SYNC/MODE Threshold       | ●                                   | 0.3 | 1.0        | 1.5     | V             |
| $I_{SYNC/MODE}$ | SYNC/MODE Leakage Current | ●                                   |     | $\pm 0.01$ | $\pm 1$ | $\mu\text{A}$ |
| $t_{SOFTSTART}$ | Soft-Start Time           | $V_{FB}$ from 10% to 90% Full Scale | 0.6 | 0.9        | 1.2     | ms            |

**Note 1:** Stresses beyond those listed under Absolute Maximum Ratings may cause permanent damage to the device. Exposure to any Absolute Maximum Rating condition for extended periods may affect device reliability and lifetime.

**Note 2:** The LTC3560E is guaranteed to meet performance specifications from  $0^\circ\text{C}$  to  $85^\circ\text{C}$ . Specifications over the  $-40^\circ\text{C}$  to  $85^\circ\text{C}$  operating temperature range are assured by design, characterization and correlation with statistical process controls. The LTC3560I is guaranteed to meet specified performance specifications over the full  $-40^\circ\text{C}$  to  $125^\circ\text{C}$  operating temperature range.

**Note 3:**  $T_J$  is calculated from the ambient temperature  $T_A$  and power dissipation  $P_D$  according to the following formula:

$$\text{LTC3560: } T_J = T_A + (P_D)(250^\circ\text{C/W})$$

**Note 4:** The LTC3560 is tested in a proprietary test mode that connects  $V_{FB}$  to the output of the error amplifier.

**Note 5:** Dynamic supply current is higher due to the gate charge being delivered at the switching frequency.

**Note 6:** Guaranteed by long-term current density limitations.

**Note 7:** This IC includes overtemperature protection that is intended to protect the device during momentary overload conditions. Junction temperature will exceed  $125^\circ\text{C}$  when overtemperature protection is active. Continuous operation above the specified maximum operating junction temperature may impair device reliability.

**TYPICAL PERFORMANCE CHARACTERISTICS**

(From Figure 1a Except for the Resistive Divider Resistor Values)

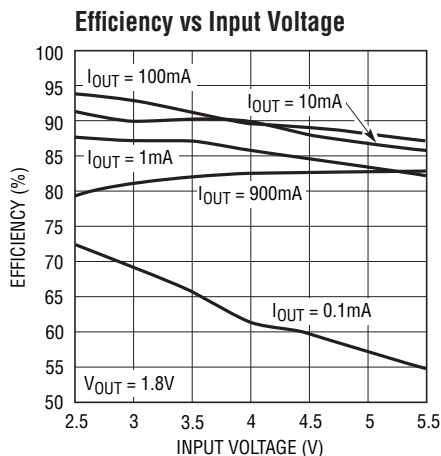

3560 G01

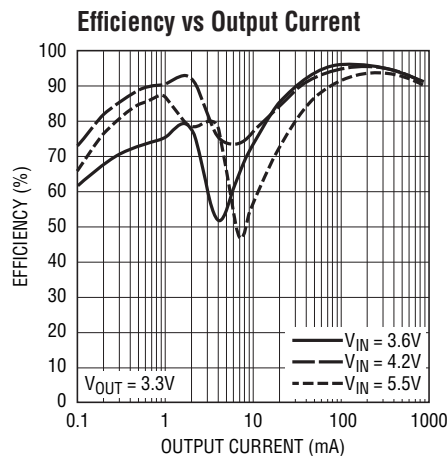

3560 G02

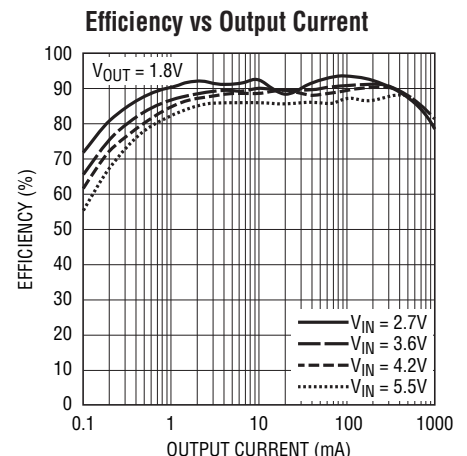

3560 G03

## TYPICAL PERFORMANCE CHARACTERISTICS

(From Figure 1a Except for the Resistive Divider Resistor Values)

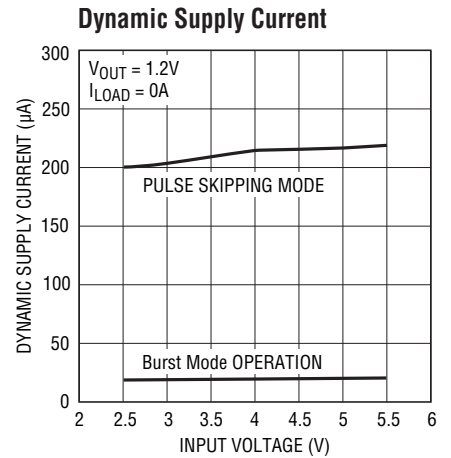
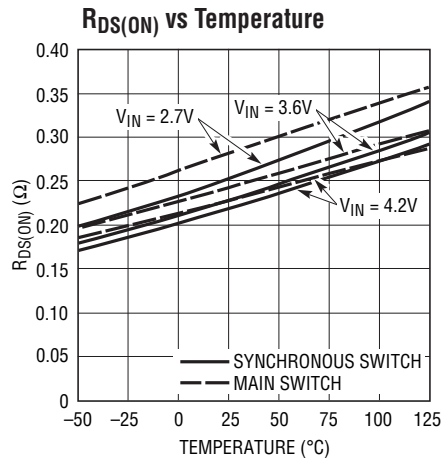
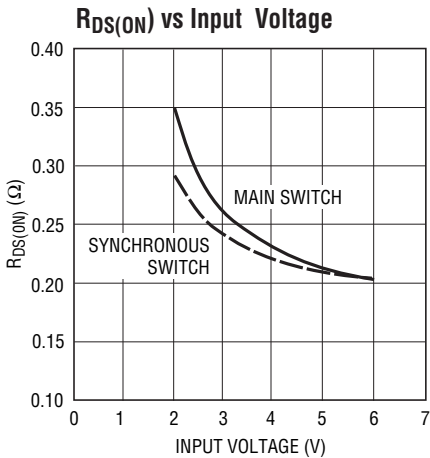
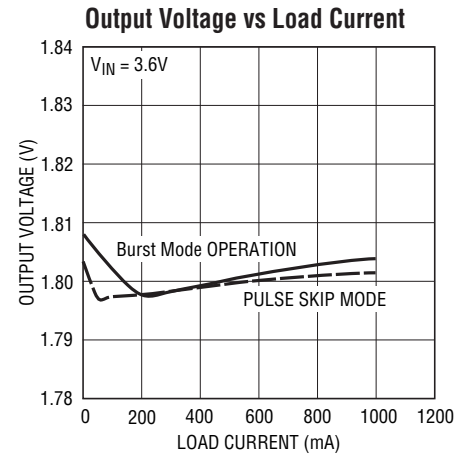
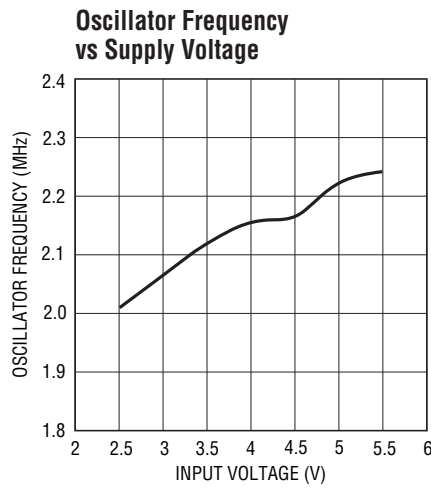
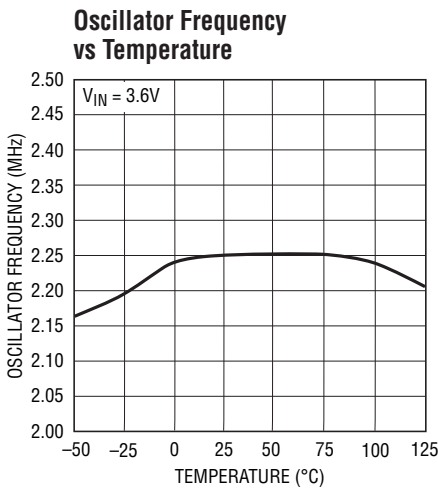
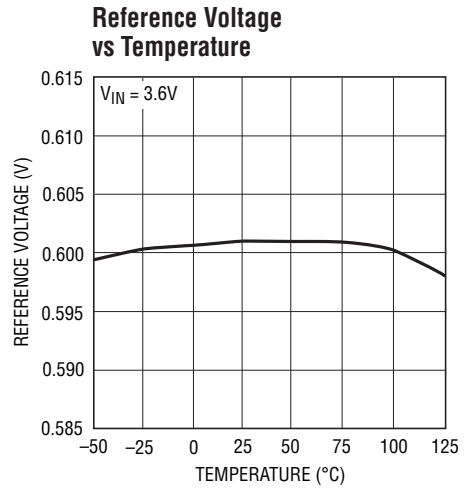
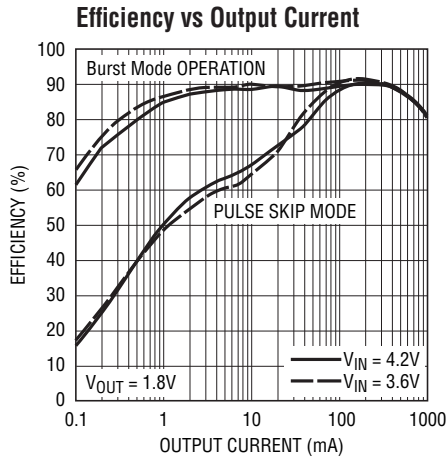
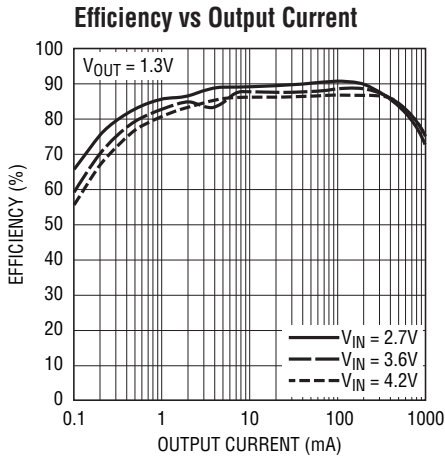

# TYPICAL PERFORMANCE CHARACTERISTICS

(From Figure 1a Except for the Resistive Divider Resistor Values)

**Dynamic Supply Current vs Temperature**

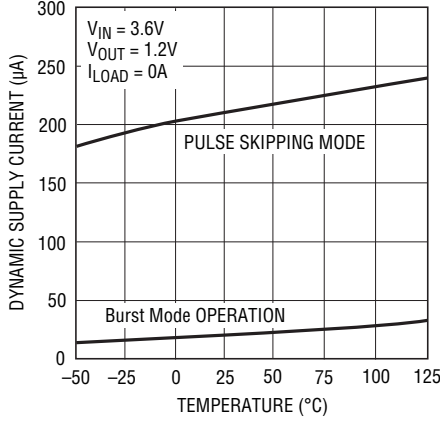

**Switch Leakage vs Temperature**

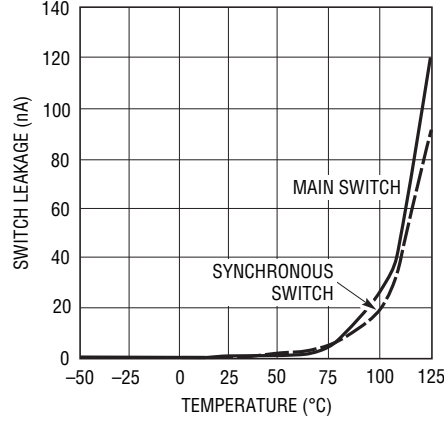

**Switch Leakage vs Input Voltage**

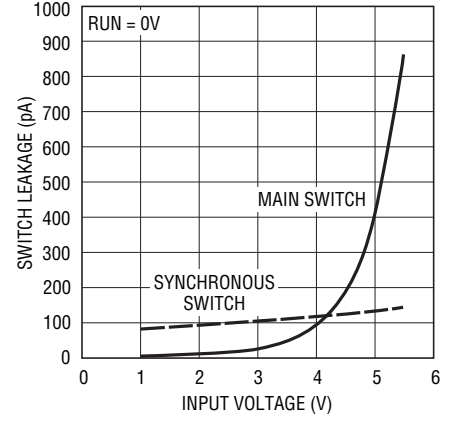

**Burst Mode Operation**

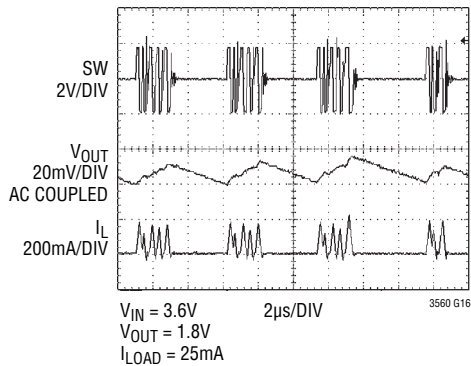

**Pulse-Skipping Mode Operation**

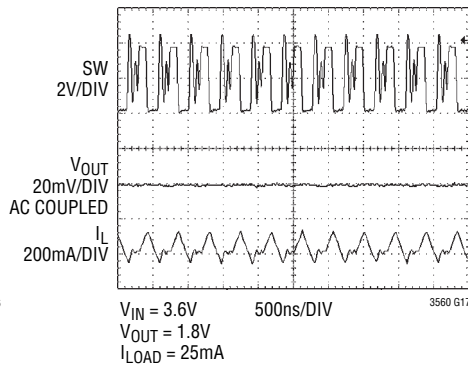

**Start-Up from Shutdown**

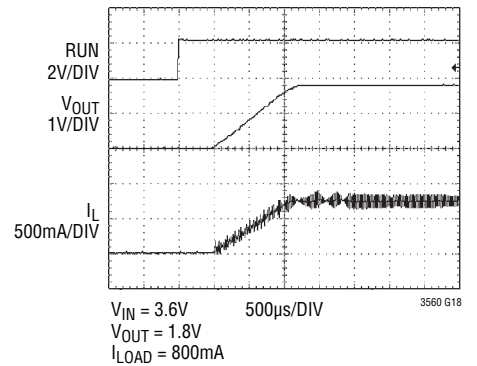

**Load Step**

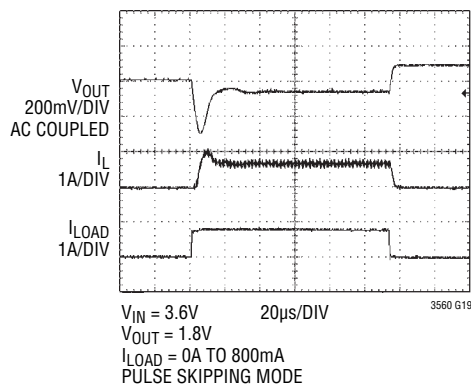

**Load Step**

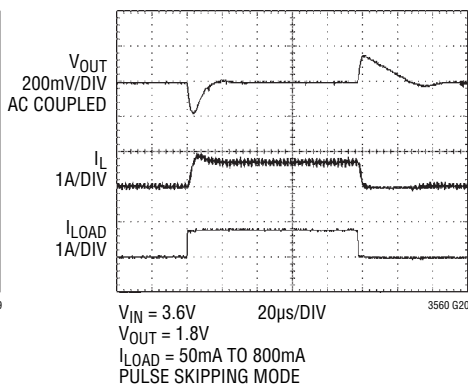

**Load Step**

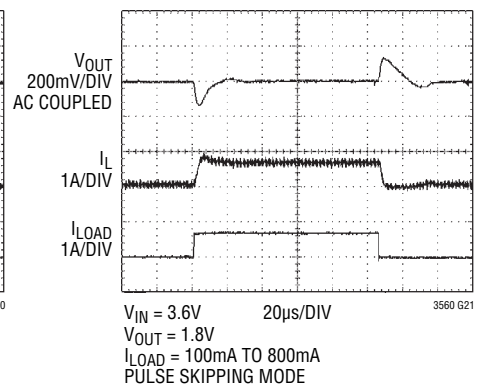

## TYPICAL PERFORMANCE CHARACTERISTICS

(From Figure 1a Except for the Resistive Divider Resistor Values)

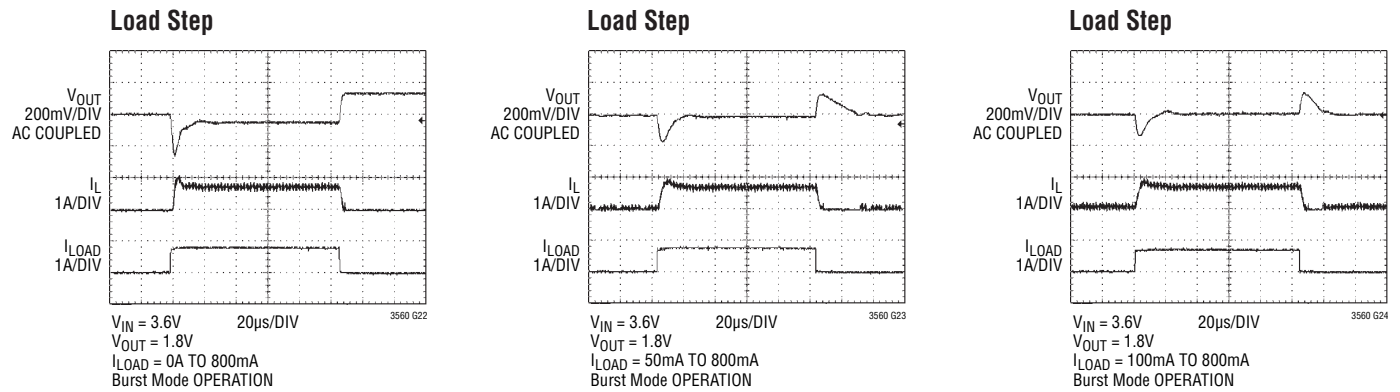

## PIN FUNCTIONS

**RUN (Pin 1):** Run Control Input. Forcing this pin above 1.5V enables the part. Forcing this pin below 0.3V shuts down the device. In shutdown, all functions are disabled drawing <math><1\mu\text{A}</math> supply current. Do not leave RUN floating.

**GND (Pin 2):** Ground Pin.

**SW (Pin 3):** Switch Node Connection to Inductor. This pin connects to the drains of the internal main and synchronous power MOSFET switches.

**V<sub>IN</sub> (Pin 4):** Main Supply Pin. Must be closely decoupled to GND, Pin 2, with a 10µF or greater ceramic capacitor.

**V<sub>FB</sub> (Pin 5):** Feedback Pin. Receives the feedback voltage from an external resistive divider across the output.

**SYNC/MODE (Pin 6):** External Clock Synchronization and Mode Select Input. To synchronize with an external clock, apply a clock with a frequency between 1MHz and 3MHz. To select pulse-skipping mode, tie to V<sub>IN</sub>. Grounding this pin selects Burst Mode operation. Do not leave this pin floating.

## FUNCTIONAL DIAGRAM

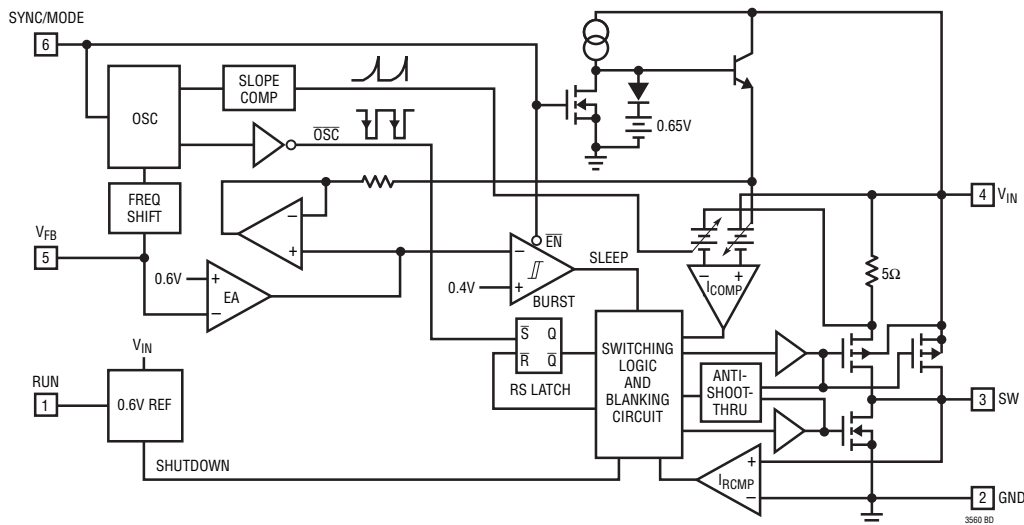

## OPERATION (Refer to Functional Diagram)

### Main Control Loop

The LTC3560 uses a constant frequency, current mode step-down architecture. Both the main (P-channel MOSFET) and synchronous (N-channel MOSFET) switches are internal. During normal operation, the internal top power MOSFET is turned on each cycle when the oscillator sets the RS latch, and turned off when the current comparator,  $I_{COMP}$ , resets the RS latch. The peak inductor current at which  $I_{COMP}$  resets the RS latch, is controlled by the output of error amplifier EA. The  $V_{FB}$  pin, described in the Pin Functions section, allows EA to receive an output feedback voltage from an external resistive divider. When the load current increases, it causes a slight decrease in the feedback voltage relative to the 0.6V reference, which in turn, causes the EA amplifier's output voltage to increase until the average inductor current matches the new load current. While the top MOSFET is off, the bottom MOSFET is turned on until either the inductor current starts to reverse, as indicated by the current reversal comparator  $I_{RCMP}$ , or the beginning of the next clock cycle.

The main control loop is shut down by grounding RUN, resetting the internal soft-start. Re-enabling the main control loop by pulling RUN high activates the internal soft-start, which slowly ramps the output voltage over approximately 0.9ms until it reaches regulation.

### Burst Mode Operation

The LTC3560 is capable of Burst Mode operation in which the internal power MOSFETs operate intermittently based on load demand. To enable Burst Mode operation, simply connect the SYNC/MODE pin to GND. To disable Burst Mode operation and enable PWM pulse-skipping mode, connect the SYNC/MODE pin to  $V_{IN}$  or drive it with a logic high ( $V_{MODE} > 1.5V$ ). In this mode, the efficiency is lower at light loads, but becomes comparable to Burst Mode operation when the output load exceeds 100mA. The advantage of pulse-skipping mode is lower output ripple and less interference to audio circuitry.

When the converter is in Burst Mode operation, the peak current of the inductor is set to approximately 150mA regardless of the output load. Each burst event can last from a few cycles at light loads to almost continuously cycling with short sleep intervals at moderate loads. In between these burst events, the power MOSFETs and any unneeded circuitry are turned off, reducing the quiescent current to 16 $\mu$ A. In this sleep state, the load current is being supplied solely from the output capacitor. As the output voltage droops, the EA amplifier's output rises above the sleep threshold signaling the BURST comparator to trip and turn the top MOSFET on. This process repeats at a rate that is dependent on the load demand.

### Frequency Synchronization

When the LTC3560 is clocked by an external source, Burst Mode operation is disabled; the LTC3560 then operates in PWM pulse-skipping mode. In this mode, when the output load is very low, current comparator  $I_{COMP}$  may remain tripped for several cycles and force the main switch to stay off for the same number of cycles. Increasing the output load slightly allows constant frequency PWM operation to resume. This mode exhibits low output ripple as well as low audio noise and reduced RF interference while providing reasonable low current efficiency.

### Dropout Operation

As the input supply voltage decreases to a value approaching the output voltage, the duty cycle increases toward the maximum on time. Further reduction of the supply voltage forces the main switch to remain on for more than one cycle until it reaches 100% duty cycle. The output voltage will then be determined by the input voltage minus the voltage drop across the P-channel MOSFET and the inductor.

Another important detail to remember is that at low input supply voltages, the  $R_{DS(ON)}$  of the P-channel switch increases (see Typical Performance Characteristics). Therefore, the user should calculate the power dissipation when the LTC3560 is used at 100% duty cycle with low input voltage (See Thermal Considerations in the Applications Information section).



## OPERATION (Refer to Functional Diagram)

### Slope Compensation and Inductor Peak Current

Slope compensation provides stability in constant frequency architectures by preventing subharmonic oscillations at high duty cycles. It is accomplished internally by adding a compensating ramp to the inductor current

signal at duty cycles in excess of 40%. Normally, this results in a reduction of maximum inductor peak current for duty cycles >40%. However, the LTC3560 uses a patented scheme that counteracts this compensating ramp, which allows the maximum inductor peak current to remain unaffected throughout all duty cycles.

## APPLICATIONS INFORMATION

The basic LTC3560 application circuit is shown in Figure 1. External component selection is driven by the load requirement and begins with the selection of L followed by  $C_{IN}$  and  $C_{OUT}$ .

### Inductor Selection

For most applications, the value of the inductor will fall in the range of  $1\mu\text{H}$  to  $3.3\mu\text{H}$ . Its value is chosen based on the desired ripple current. Large value inductors lower ripple current and small value inductors result in higher ripple currents. Higher  $V_{IN}$  or  $V_{OUT}$  also increases the ripple current as shown in equation 1. A reasonable starting point for setting ripple current is  $\Delta I_L = 320\text{mA}$  (40% of 800mA).

$$\Delta I_L = \frac{1}{(f)(L)} V_{OUT} \left( 1 - \frac{V_{OUT}}{V_{IN}} \right) \quad (1)$$

The DC current rating of the inductor should be at least equal to the maximum load current plus half the ripple

current to prevent core saturation. Thus, a 960mA rated inductor should be enough for most applications (800mA + 160mA). For better efficiency, choose a low DC-resistance inductor.

The inductor value also has an effect on Burst Mode operation. The transition to low current operation begins when the inductor current peaks fall to approximately 200mA. Lower inductor values (higher  $\Delta I_L$ ) will cause this to occur at lower load currents, which can cause a dip in efficiency in the upper range of low current operation. In Burst Mode operation, lower inductance values will cause the burst frequency to increase.

### Inductor Core Selection

Different core materials and shapes will change the size/current and price/current relationship of an inductor. Toroid or shielded pot cores in ferrite or permalloy materials are small and don't radiate much energy, but generally cost

**Table 1. Representative Surface Mount Inductors**

| MANUFACTURER | PART NUMBER        | VALUE             | MAX DC CURRENT | DCR           | HEIGHT |
|--------------|--------------------|-------------------|----------------|---------------|--------|
| Toko         | A960AW-1R2M-518LC  | 1.2 $\mu\text{H}$ | 1.8A           | 46m $\Omega$  | 1.8mm  |
|              | A960AW-2R3M-518LC  | 2.3 $\mu\text{H}$ | 1.5A           | 63m $\Omega$  | 1.8mm  |
|              | A997AS-3R3M-DB318L | 3.3 $\mu\text{H}$ | 1.2A           | 70m $\Omega$  | 1.8mm  |
| Sumida       | CDRH2D11/HP-1R5    | 1.5 $\mu\text{H}$ | 1.35A          | 64m $\Omega$  | 1.2mm  |
|              | CDRH3D11/HP-1R5    | 1.5 $\mu\text{H}$ | 2A             | 80m $\Omega$  | 1.2mm  |
|              | CDRH2D18/HP-2R2    | 2.2 $\mu\text{H}$ | 1.6A           | 48m $\Omega$  | 2.0mm  |
|              | CDRH2D14-3R3       | 3.3 $\mu\text{H}$ | 1.2A           | 100m $\Omega$ | 1.55mm |
| TDK          | VLF3010AT-1R5M1R2  | 1.5 $\mu\text{H}$ | 1.2A           | 68m $\Omega$  | 1.0mm  |
|              | VLF3010AT-2R2M1R0  | 2.2 $\mu\text{H}$ | 1.0A           | 100m $\Omega$ | 1.0mm  |
| Coilcraft    | D01608C-222        | 2.2 $\mu\text{H}$ | 2.3A           | 70m $\Omega$  | 3.0mm  |
|              | LP01704-222M       | 2.2 $\mu\text{H}$ | 2.4A           | 120m $\Omega$ | 1.0mm  |
| Cooper       | SD3112-2R2         | 2.2 $\mu\text{H}$ | 1.1A           | 140m $\Omega$ | 1.2mm  |
| EPCO         | B82470A1222M       | 2.2 $\mu\text{H}$ | 1.6A           | 90m $\Omega$  | 1.2mm  |



## APPLICATIONS INFORMATION

more than powdered iron core inductors with similar electrical characteristics. The choice of which style inductor to use often depends more on the price versus size requirements and any radiated field/EMI requirements than on what the LTC3560 requires to operate. Table 1 shows some typical surface mount inductors that work well in LTC3560 applications.

### $C_{IN}$ and $C_{OUT}$ Selection

In continuous mode, the source current of the top MOSFET is a square wave of duty cycle  $V_{OUT}/V_{IN}$ . To prevent large voltage transients, a low ESR input capacitor sized for the maximum RMS current must be used. The maximum RMS capacitor current is given by:

$$C_{IN} \text{ required } I_{RMS} \cong I_{OMAX} \frac{[V_{OUT}(V_{IN}-V_{OUT})]^{1/2}}{V_{IN}}$$

This formula has a maximum at  $V_{IN} = 2V_{OUT}$ , where  $I_{RMS} = I_{OUT}/2$ . This simple worst-case condition is commonly used for design because even significant deviations do not offer much relief. Note that the capacitor manufacturer's ripple current ratings are often based on 2000 hours of life. This makes it advisable to further derate the capacitor, or choose a capacitor rated at a higher temperature than required. Always consult the manufacturer if there is any question.

The selection of  $C_{OUT}$  is driven by the required effective series resistance (ESR). Typically, once the ESR requirement for  $C_{OUT}$  has been met, the RMS current rating generally far exceeds the  $I_{RIPPLE(P-P)}$  requirement. The output ripple  $\Delta V_{OUT}$  is determined by:

$$\Delta V_{OUT} \cong \Delta I_L \left( ESR + \frac{1}{8fC_{OUT}} \right)$$

where  $f$  = operating frequency,  $C_{OUT}$  = output capacitance and  $\Delta I_L$  = ripple current in the inductor. For a fixed output voltage, the output ripple is highest at maximum input voltage since  $\Delta I_L$  increases with input voltage.

If tantalum capacitors are used, it is critical that the capacitors are surge tested for use in switching power supplies. An excellent choice is the AVX TPS series of surface mount tantalum. These are specially constructed and tested for low ESR so they give the lowest ESR for a given volume. Other capacitor types include Sanyo POSCAP, Kemet T510 and T495 series, and Sprague 593D and 595D series. Consult the manufacturer for other specific recommendations.

### Using Ceramic Input and Output Capacitors

Higher values, lower cost ceramic capacitors are now becoming available in smaller case sizes. Their high ripple current, high voltage rating and low ESR make them ideal for switching regulator applications. Because the LTC3560's control loop does not depend on the output capacitor's ESR for stable operation, ceramic capacitors can be used freely to achieve very low output ripple and small circuit size.

However, care must be taken when ceramic capacitors are used at the input and the output. When a ceramic capacitor is used at the input and the power is supplied by a wall adapter through long wires, a load step at the output can induce ringing at the input,  $V_{IN}$ . At best, this ringing can couple to the output and be mistaken as loop instability. At worst, a sudden inrush of current through the long wires can potentially cause a voltage spike at  $V_{IN}$ , large enough to damage the part.

When choosing the input and output ceramic capacitors, choose the X5R or X7R dielectric formulations. These dielectrics have the best temperature and voltage characteristics of all the ceramics for a given value and size.

### Output Voltage Programming

The output voltage is set by a resistive divider according to the following formula:

$$V_{OUT} = 0.6V \left( 1 + \frac{R2}{R1} \right) \quad (2)$$

The external resistive divider is connected to the output, allowing remote voltage sensing as shown in Figure 2.

## APPLICATIONS INFORMATION

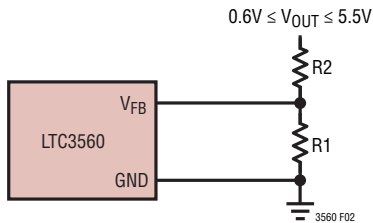

Figure 2. Setting the LTC3560 Output Voltage

## Efficiency Considerations

The efficiency of a switching regulator is equal to the output power divided by the input power times 100%. It is often useful to analyze individual losses to determine what is limiting the efficiency and which change would produce the most improvement. Efficiency can be expressed as:

$$\text{Efficiency} = 100\% - (L1 + L2 + L3 + \dots)$$

where L1, L2, etc. are the individual losses as a percentage of input power.

Although all dissipative elements in the circuit produce losses, two main sources usually account for most of the losses in LTC3560 circuits:  $V_{IN}$  quiescent current and  $I^2R$  losses. The  $V_{IN}$  quiescent current loss dominates the efficiency loss at very low load currents whereas the  $I^2R$  loss dominates the efficiency loss at medium to high load currents. In a typical efficiency plot, the efficiency curve at very low load currents can be misleading since the actual power lost is of no consequence as illustrated in Figure 3.

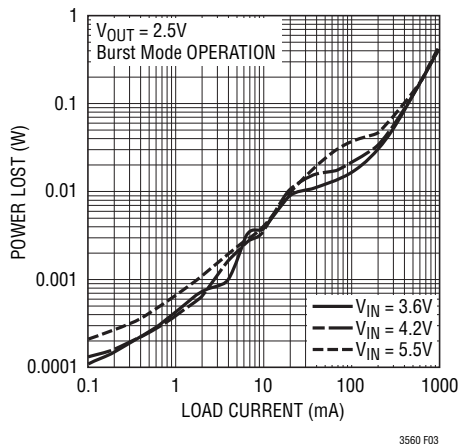

Figure 3. Power Lost vs Load Current

1. The  $V_{IN}$  quiescent current is due to two components: the DC bias current as given in the electrical characteristics and the internal main switch and synchronous switch gate charge currents. The gate charge current results from switching the gate capacitance of the internal power MOSFET switches. Each time the gate is switched from high to low to high again, a packet of charge,  $dQ$ , moves from  $V_{IN}$  to ground. The resulting  $dQ/dt$  is the current out of  $V_{IN}$  that is typically larger than the DC bias current. In continuous mode,  $I_{GATECHG} = f(Q_T + Q_B)$  where  $Q_T$  and  $Q_B$  are the gate charges of the internal top and bottom switches. Both the DC bias and gate charge losses are proportional to  $V_{IN}$  and thus their effects will be more pronounced at higher supply voltages.
2.  $I^2R$  losses are calculated from the resistances of the internal switches,  $R_{SW}$ , and external inductor  $R_L$ . In continuous mode, the average output current flowing through inductor L is "chopped" between the main switch and the synchronous switch. Thus, the series resistance looking into the SW pin is a function of both top and bottom MOSFET  $R_{DS(ON)}$  and the duty cycle (DC) as follows:

$$R_{SW} = (R_{DS(ON)TOP})(DC) + (R_{DS(ON)BOT})(1 - DC)$$

The  $R_{DS(ON)}$  for both the top and bottom MOSFETs can be obtained from the Typical Performance Characteristics curves. Thus, to obtain  $I^2R$  losses, simply add  $R_{SW}$  to  $R_L$  and multiply the result by the square of the average output current.

Other losses including  $C_{IN}$  and  $C_{OUT}$  ESR dissipative losses and inductor core losses generally account for less than 2% total additional loss.

## Thermal Considerations

In most applications the LTC3560 does not dissipate much heat due to its high efficiency. But, in applications where the LTC3560 is running at high ambient temperature with low supply voltage and high duty cycles, such as in dropout, the heat dissipated may exceed the maximum junction temperature of the part. If the junction temperature reaches approximately 150°C, both power

## APPLICATIONS INFORMATION

switches will be turned off and the SW node will become high impedance.

To avoid the LTC3560 from exceeding the maximum junction temperature, the user will need to do some thermal analysis. The goal of the thermal analysis is to determine whether the power dissipated exceeds the maximum junction temperature of the part. The temperature rise is given by:

$$T_R = (P_D)(\theta_{JA})$$

where  $P_D$  is the power dissipated by the regulator and  $\theta_{JA}$  is the thermal resistance from the junction of the die to the ambient temperature.

The junction temperature,  $T_J$ , is given by:

$$T_J = T_A + T_R$$

where  $T_A$  is the ambient temperature.

As an example, consider the LTC3560 in dropout at an input voltage of 2.7V, a load current of 800mA and an ambient temperature of 70°C. From the typical performance graph of switch resistance, the  $R_{DS(ON)}$  of the P-channel switch at 70°C is approximately 0.31Ω. Therefore, power dissipated by the part is:

$$P_D = I_{LOAD}^2 \cdot R_{DS(ON)} = 198\text{mW}$$

For the SOT-23 package, the  $\theta_{JA}$  is 250°C/W. Thus, the junction temperature of the regulator is:

$$T_J = 70^\circ\text{C} + (0.198)(250) = 120^\circ\text{C}$$

which is below the maximum junction temperature of 125°C.

Note that at higher supply voltages, the junction temperature is lower due to reduced switch resistance ( $R_{DS(ON)}$ ).

### Checking Transient Response

The regulator loop response can be checked by looking at the load transient response. Switching regulators take several cycles to respond to a step in load current. When a load step occurs,  $V_{OUT}$  immediately shifts by an amount equal to  $(\Delta I_{LOAD} \cdot \text{ESR})$ , where ESR is the effective series resistance of  $C_{OUT}$ .  $\Delta I_{LOAD}$  also begins to charge or discharge  $C_{OUT}$ , which generates a feedback error signal. The regulator loop then acts to return  $V_{OUT}$  to its

steady-state value. During this recovery time  $V_{OUT}$  can be monitored for overshoot or ringing that would indicate a stability problem. For a detailed explanation of switching control loop theory, see Application Note 76.

A second, more severe transient is caused by switching in loads with large ( $>1\mu\text{F}$ ) supply bypass capacitors. The discharged bypass capacitors are effectively put in parallel with  $C_{OUT}$ , causing a rapid drop in  $V_{OUT}$ . No regulator can deliver enough current to prevent this problem if the load switch resistance is low and it is driven quickly. The only solution is to limit the rise time of the switch drive so that the load rise time is limited to approximately  $(25 \cdot C_{LOAD})$ . Thus, a 10μF capacitor charging to 3.3V would require a 250μs rise time, limiting the charging current to about 130mA.

### PC Board Layout Checklist

When laying out the printed circuit board, the following checklist should be used to ensure proper operation of the LTC3560. These items are also illustrated graphically in Figures 4 and 5. Check the following in your layout:

1. The power traces, consisting of the GND trace, the SW trace and the  $V_{IN}$  trace should be kept short, direct and wide.
2. Does the  $V_{FB}$  pin connect directly to the feedback resistors? The resistive divider R1/R2 must be connected between the (+) plate of  $C_{OUT}$  and ground.
3. Does the (+) plate of  $C_{IN}$  connect to  $V_{IN}$  as closely as possible? This capacitor provides the AC current to the internal power MOSFETs.
4. Keep the (–) plates of  $C_{IN}$  and  $C_{OUT}$  as close as possible.
5. Keep the switching node, SW, away from the sensitive  $V_{FB}$  node.

### Design Example

As a design example, assume the LTC3560 is used in a single lithium-ion battery-powered cellular phone application. The  $V_{IN}$  will be operating from a maximum of 4.2V down to about 2.7V. The load current requirement is a maximum of 0.8A but most of the time it will be in

## APPLICATIONS INFORMATION

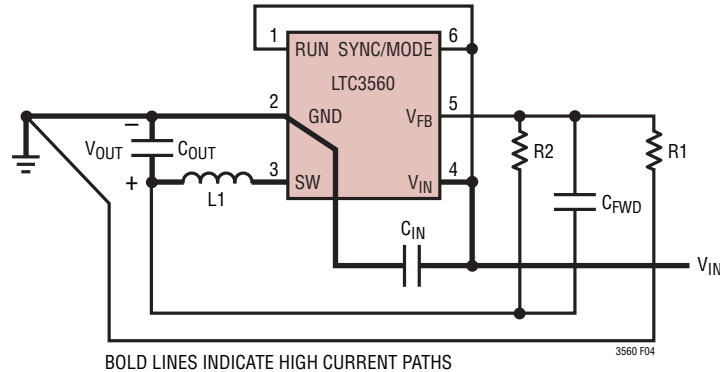

Figure 4. LTC3560 Layout Diagram

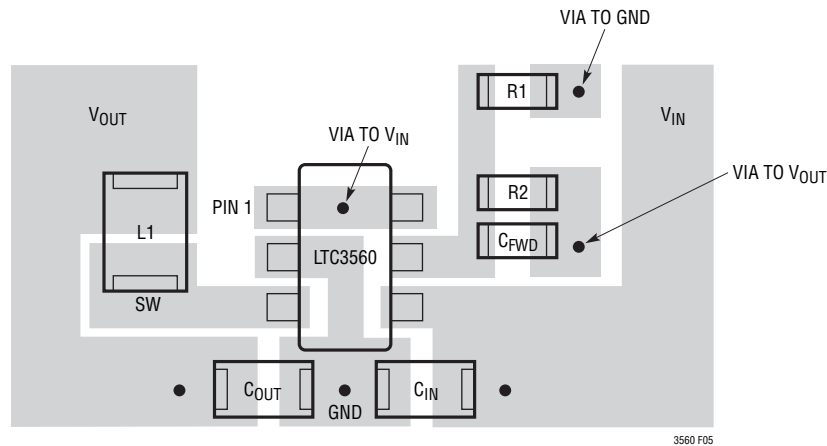

Figure 5. LTC3560 Suggested Layout

standby mode, requiring only 2mA. Efficiency at both low and high load currents is important. Output voltage is 2.5V. With this information we can calculate L using equation (1),

$$L = \frac{1}{(f)(\Delta I_L)} V_{OUT} \left( 1 - \frac{V_{OUT}}{V_{IN}} \right) \quad (3)$$

Substituting  $V_{OUT} = 2.5V$ ,  $V_{IN} = 4.2V$ ,  $\Delta I_L = 320mA$  and  $f = 2.25MHz$  in equation (3) gives:

$$L = \frac{2.5V}{2.25MHz(320mA)} \left( 1 - \frac{2.5V}{4.2V} \right) \cong 1.4\mu H$$

A 1.5 $\mu H$  inductor works well for this application. For best efficiency choose a 960mA or greater inductor with less than 0.2 $\Omega$  series resistance.

$C_{IN}$  will require an RMS current rating of at least  $0.4A \cong I_{LOAD(MAX)}/2$  at temperature and  $C_{OUT}$  will require an ESR of less than 0.1 $\Omega$ . In most cases, a ceramic capacitor will satisfy this requirement.

For the feedback resistors, choose  $R1 = 309k$ .  $R2$  can then be calculated from equation (2) to be:

$$R2 = \left( \frac{V_{OUT}}{0.6} - 1 \right) R1 = 978.5k; \text{ use } 976k$$

Figure 6 shows the complete circuit along with its efficiency curve.

# APPLICATIONS INFORMATION

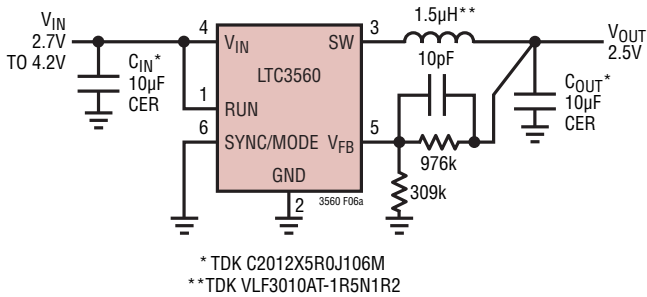

Figure 6a

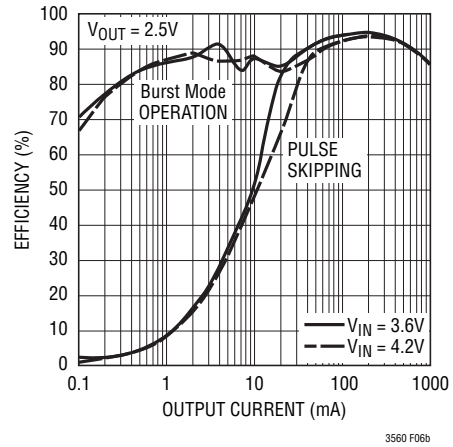

Figure 6b

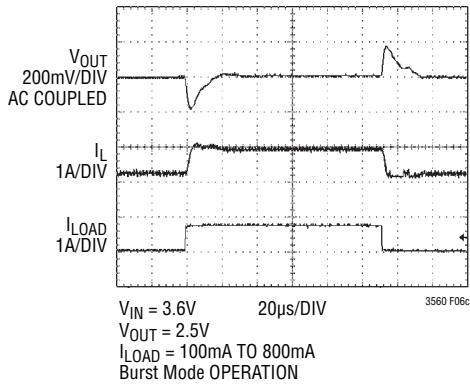

Figure 6c

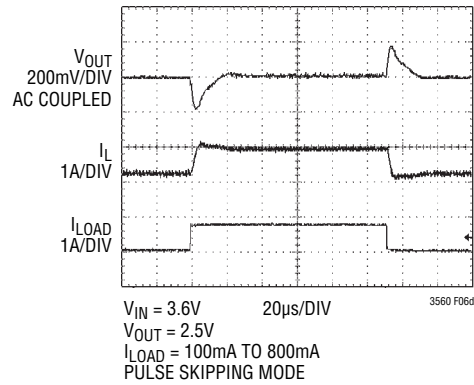

Figure 6d

## APPLICATIONS INFORMATION

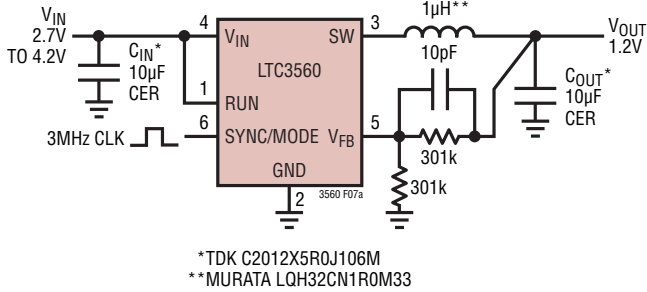

Figure 7a

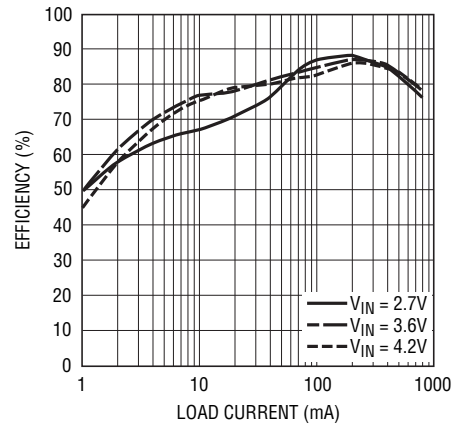

Figure 7b

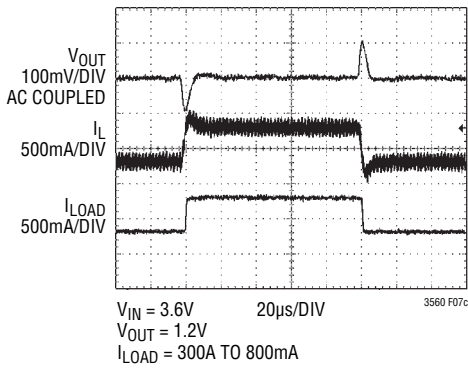

Figure 7c

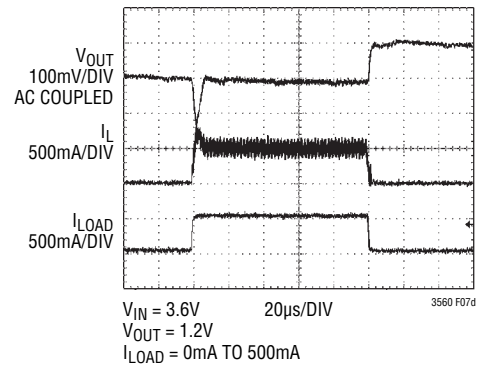
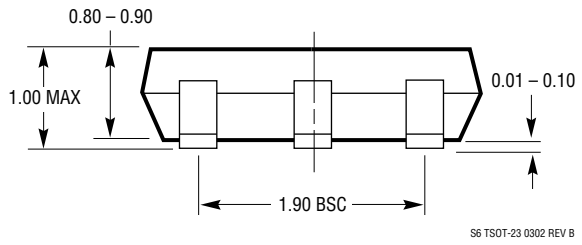
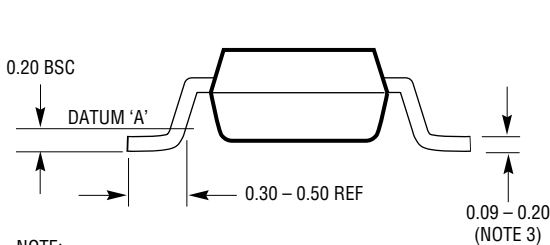
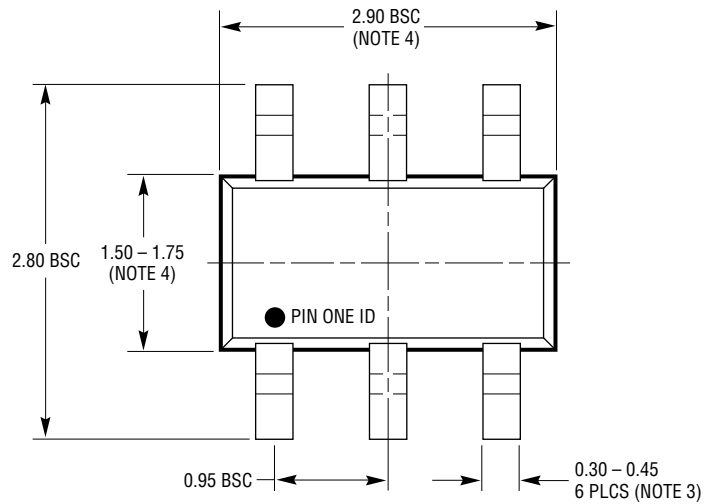
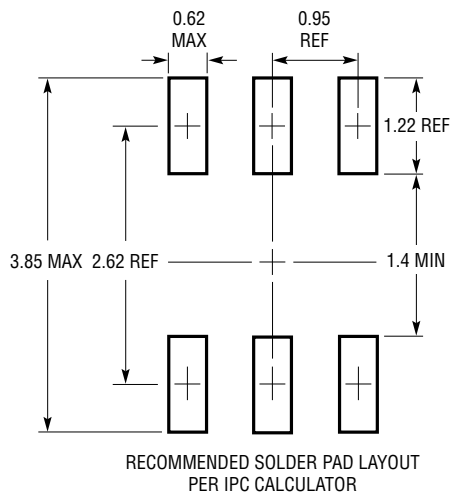

Figure 7d



# PACKAGE DESCRIPTION

**S6 Package**  
**6-Lead Plastic TSOT-23**  
 (Reference LTC DWG # 05-08-1636)



- NOTE:
1. DIMENSIONS ARE IN MILLIMETERS
  2. DRAWING NOT TO SCALE
  3. DIMENSIONS ARE INCLUSIVE OF PLATING
  4. DIMENSIONS ARE EXCLUSIVE OF MOLD FLASH AND METAL BURR
  5. MOLD FLASH SHALL NOT EXCEED 0.254mm
  6. JEDEC PACKAGE REFERENCE IS MO-193

S6 TSOT-23 0302 REV B

# LTC3560

## RELATED PARTS

| PART NUMBER                       | DESCRIPTION  | COMMENTS   |
|-----------------------------------|--|--|
| LTC3405/LTC3405A                  | 300mA ( $I_{OUT}$ ), 1.5MHz, Synchronous Step-Down DC/DC Converters                    | 95% Efficiency, $V_{IN}$ : 2.5V to 5.5V, $V_{OUT(MIN)} = 0.8V$ , $I_Q = 20\mu A$ , $I_{SD} = <1\mu A$ , ThinSOT Package            |
| LTC3406/LTC3406B                  | 600mA ( $I_{OUT}$ ), 1.5MHz, Synchronous Step-Down DC/DC Converters                    | 96% Efficiency, $V_{IN}$ : 2.5V to 5.5V, $V_{OUT(MIN)} = 0.6V$ , $I_Q = 20\mu A$ , $I_{SD} = <1\mu A$ , ThinSOT Package            |
| LTC3407/LTC3407-2                 | Dual 600mA/800mA ( $I_{OUT}$ ), 1.5MHz/2.25MHz, Synchronous Step-Down DC/DC Converters | 95% Efficiency, $V_{IN}$ : 2.5V to 5.5V, $V_{OUT(MIN)} = 0.6V$ , $I_Q = 40\mu A$ , $I_{SD} = <1\mu A$ , MS10E, DFN Packages        |
| LTC3409                           | 600mA ( $I_{OUT}$ ), 1.7MHz/2.6MHz, Synchronous Step-Down DC/DC Converter              | 96% Efficiency, $V_{IN}$ : 1.6V to 5.5V, $V_{OUT(MIN)} = 0.6V$ , $I_Q = 65\mu A$ , $I_{SD} = <1\mu A$ , DFN Package                |
| LTC3410/LTC3410B                  | 300mA ( $I_{OUT}$ ), 2.25MHz, Synchronous Step-Down DC/DC Converters                   | 95% Efficiency, $V_{IN}$ : 2.5V to 5.5V, $V_{OUT(MIN)} = 0.8V$ , $I_Q = 26\mu A$ , $I_{SD} = <1\mu A$ , SC70 Package               |
| LTC3411                           | 1.25A ( $I_{OUT}$ ), 4MHz, Synchronous Step-Down DC/DC Converter                       | 95% Efficiency, $V_{IN}$ : 2.5V to 5.5V, $V_{OUT(MIN)} = 0.8V$ , $I_Q = 60\mu A$ , $I_{SD} = <1\mu A$ , MS10, DFN Packages         |
| LTC3412                           | 2.5A ( $I_{OUT}$ ), 4MHz, Synchronous Step-Down DC/DC Converter                        | 95% Efficiency, $V_{IN}$ : 2.5V to 5.5V, $V_{OUT(MIN)} = 0.8V$ , $I_Q = 60\mu A$ , $I_{SD} = <1\mu A$ , TSSOP-16E Package          |
| LTC3441/LTC3442/<br>LTC3443       | 1.2A ( $I_{OUT}$ ), 2MHz, Synchronous Buck-Boost DC/DC Converters                      | 95% Efficiency, $V_{IN}$ : 2.4V to 5.5V, $V_{OUT(MIN)}$ : 2.4V to 5.25V, $I_Q = 50\mu A$ , $I_{SD} = <1\mu A$ , DFN Package        |
| LTC3531/LTC3531-3/<br>LTC3531-3.3 | 200mA ( $I_{OUT}$ ), 1.5MHz, Synchronous Buck-Boost DC/DC Converters                   | 95% Efficiency, $V_{IN}$ : 1.8V to 5.5V, $V_{OUT(MIN)}$ : 2V to 5V, $I_Q = 16\mu A$ , $I_{SD} = <1\mu A$ , ThinSOT, DFN Packages   |
| LTC3532                           | 500mA ( $I_{OUT}$ ), 2MHz, Synchronous Buck-Boost DC/DC Converter                      | 95% Efficiency, $V_{IN}$ : 2.4V to 5.5V, $V_{OUT(MIN)}$ : 2.4V to 5.25V, $I_Q = 35\mu A$ , $I_{SD} = <1\mu A$ , MS10, DFN Packages |
| LTC3548/LTC3548-1/<br>LTC3548-2   | Dual 400mA/800mA ( $I_{OUT}$ ), 2.25MHz, Synchronous Step-Down DC/DC Converters        | 95% Efficiency, $V_{IN}$ : 2.5V to 5.5V, $V_{OUT(MIN)} = 0.6V$ , $I_Q = 40\mu A$ , $I_{SD} = <1\mu A$ , MS10E, DFN Packages        |
| LTC3561                           | 1.25A ( $I_{OUT}$ ), 4MHz, Synchronous Step-Down DC/DC Converter                       | 95% Efficiency, $V_{IN}$ : 2.5V to 5.5V, $V_{OUT(MIN)} = 0.8V$ , $I_Q = 240\mu A$ , $I_{SD} = <1\mu A$ , DFN Package               |