

Please read CAUTION and Notice in this catalog for safety. This catalog has only typical specifications. Therefore you are requested to approve our product specification or to transact the approval sheet for product specification, before your ordering.

N16E9.pdf 01.11.26

SIP Resistor Network

R-NETWORK

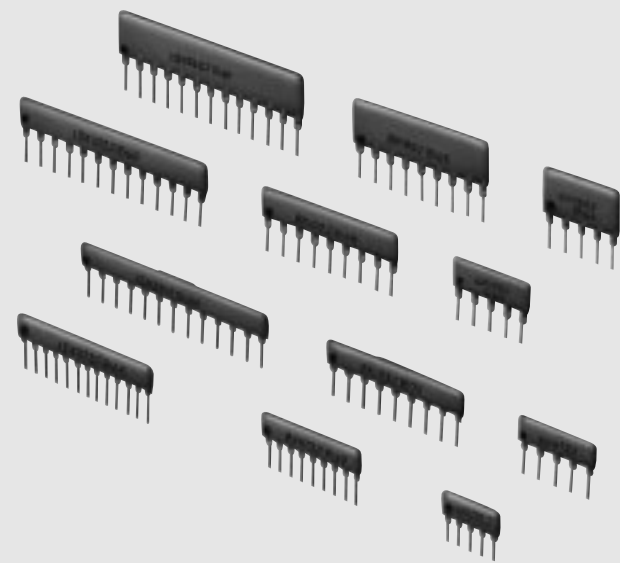

muRata *Innovator
in Electronics*
Murata
Manufacturing Co., Ltd.

Cat.No.N16E-9

CONTENTS

1

Part Numbering	2
SIP Resistor Network Features / Applications	3
1 Standard Resistor Network RGLD Series	4
2 Shrink Pitch Resistor Network RGLE Series	6
3 High-Power Isolated Resistor Network RGSD Series	8
4 R/2R Ladder Resistor Network RGSD Series	10
5 Custom Resistor Network Series	12
Performance and Test Method	14
Packaging	15
Minimum Quantity	15
⚠Caution / Notice	16
ISO9000 Certifications	17

2

3

4

5

● **Part Numbering** (The structure of the "Global Part Numbers" that have been adopted since June 2001 and the meaning of each code are described herein.)
 (If you have any questions about details, inquire at your usual Murata sales office or distributor.)

R Network

(Global Part Number)

X, Y, L Circuit **RG** **LD** **8** **X** **103** **J** **T2**

① ② ③ ④ ⑤ ⑥ ⑨

Z, M Circuit **RG** **LD** **8** **M** **103** **J** **104** **J** **T2**

① ② ③ ④ ⑤ ⑥ ⑦ ⑧ ⑨

Custom Circuit **RG** **LD** **8** **A** **1234**

① ② ③ ④ ⑩

① Product ID

Product ID	
RG	R Networks

② Structure

Code	Structure
LD	Terminal Pitch : 2.54mm, Height : 5.0mm max.
LE	Terminal Pitch : 1.78mm, Height : 5.0mm max.
SD	Terminal Pitch : 2.54mm, Height : 6.5mm max.
HD	Terminal Pitch : 2.54mm, Height : 9.0mm max.

③ Number of Element

Code	Number of Element
8	1 or 2 digits shows the number of element.

④ Circuit

Code	Circuit
X	Pull-up, Pull-down Circuit
Y	Isolated Circuit
Z	Double Terminator Circuit
M	Divider Circuit
L	R/2R Ladder Circuit
A	Custom Circuit

⑤ Nominal Resistance (Z, M Circuit : R_A)
 (L Circuit : Output Impedance)

Expressed by three figures. The unit is ohm (Ω). The first and second figures are significant digits, and the third figure expresses the number of zeros which follow the two figures.

Ex.)

Code	Nominal Resistance
150	15 Ω
103	10k Ω

⑥ Resistance Tolerance (Z, M Circuit : R_A)
 (L Circuit : Impedance Tolerance)

Code	Resistance Tolerance
J	$\pm 5\%$
G	$\pm 2\%$ (22 Ω min.)

⑦ Nominal Resistance (Z, M Circuit : R_B)

Expressed by three figures. The unit is ohm (Ω). The first and second figures are significant digits, and the third figure expresses the number of zeros which follow the two figures.

Ex.)

Code	Nominal Resistance
150	15 Ω
104	100k Ω

If R_A and R_B values are the same, ⑦ and ⑥ remain blanks, and the corresponding code is omitted.

⑧ Resistance Tolerance (Z, M Circuit : R_B)

Code	Resistance Tolerance
J	$\pm 5\%$
G	$\pm 2\%$ (22 Ω min.)

⑨ Packaging

Code	Packaging
T1	All-Pin Taping
T2	3pins Taping

⑩ Design No.

Code	Design No.
1234	Expressed by four figures

SIP Resistor Network Features/Applications

These high quality SIP resistor networks are designed using Murata's years of experience in thick film resistor technology. Their reliability is assured by a massproduction system that puts quality first.

■Features

1. Various Types

Murata's R-networks are designed to meet a wide variety of resistor needs. Three types are available : standard low profile (approximately the same height as ICs, 5mm max.), middle profile, and high profile.

Series Name

Height	Pin Pitch		Remarks
	2.54mm	1.78mm	
9.0mm max.	RGHD	—	Custom Series
6.5mm max.	RGSD	—	Custom Series
5.0mm max.	RGLD	RGLE	Standard Series

2. Standard Circuits

Murata offers the circuits shown below in the standard series; they are frequently used in digital circuits and equipment. Also, Murata produces various custom products to fully meet the customer's needs.

Standard Circuits

Type Code	X Type	Y Type	M Type	Z Type	L Type (RGSD)
Circuit					

3. Compact Design

Compact design allows these resistors to be used in applications requiring high density insertion. An added feature of the 2.54mm pitch types enables insertion along rows and lines of holes with the same pitch.

4. Automatic Insertion

To meet demands to decrease assembly and labor costs, Murata offers two taping types. This allows the products to be automatically inserted in the same way as general radial taping parts. Please note that some automatic insertion machines are not supported.

■Applications

● Home Electronics

Color TVs, VCRs, audio equipment, home appliances containing microcomputers (air-conditioners, fan-heaters, washing machines, refrigerators, microwave ovens, etc.).

● Industrial Equipment

Computer and peripheral devices, office supplies (printers, word-processors, plain paper copiers, electric typewriters, etc.) Communication equipment (telephones, digital exchanges, communication systems, etc.) Programmable controllers, Measuring equipment, Car electronics and other types of equipment.

SIP Resistor Network



Standard Resistor Network RGLD Series

■Features

1. The popular RGLD series has standard low profile dimensions equivalent to those of an IC (height : 5.0mm max. ; pitch : 2.54mm).
2. Available in tape packaging to meet assembly cost reduction demands.
3. Products of this series are used in standard digital circuits.

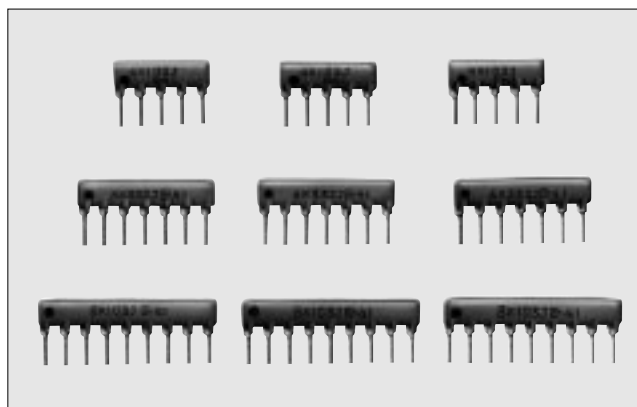

■Standard Circuits

Circuit Type	Pull up, Pull down	Isolated	Double Terminator	Divider
Type Code	X Type	Y Type	Z Type	M Type
Circuit				
Number of Elements (Pins)	n=3 to 12 (4 to 13)	n=3 to 7 (6 to 14)	n=8 to 18 (even number) (6 to 11)	n=6 to 12 (even number) (7 to 13)

• Products with other circuits and other element numbers are also available as custom parts.

■Rating

	RGLD \overline{n} X Type	RGLD \overline{n} Y Type	RGLD \overline{n} M Type	RGLD \overline{n} Z Type
Power Rating Each Resistor *1	1/8W	1/8W	1/8W	1/8W
Total Rated Power	1/8W×Number of elements (n)	1/8W×Number of elements (n)	1/8W×Number of elements (n)	1/8W×Number of elements (n) X0.6
Rated Voltage *2	Rated voltage (V) = $\sqrt{\text{Power rating (W)} \times \text{Nominal resistance value } (\Omega)}$			
Standard Resistance	E-12 series*3			The following values*4
Resistance Range	10(Ω) to 1M Ω			
Resistance Tolerance*5	J : $\pm 5\%$, G : $\pm 2\%$ (22 Ω min.)			
Temp.Coeff.of Resistance	$\pm 200\text{ppm}/^\circ\text{C}$			
Max. Operating Voltage	100V			
Operating Temperature	-55 to +125 $^\circ\text{C}$			

*1 Derating Curve
The rated power per element and the total rated power are derated according to the following curve.

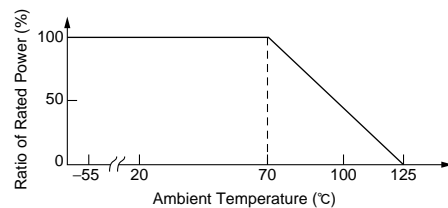

*2 When rated voltage exceeds the max. operating voltage, the max. operating voltage shall be regarded as the rated voltage.

*3 E-12 Standard Values

10, 12, 15, 18, 22, 27,

33, 39, 47, 56, 68, 82

*4 Standard Resistance Value for Z type (Ω)

RA/RB=180/390, 220/330, 330/390, 330/470

*5 Resistance tolerance : $\pm 1\%$, T.C.R : $\pm 100\text{ppm}/^\circ\text{C}$ is also available.

Please read CAUTION and Notice in this catalog for safety. This catalog has only typical specifications. Therefore you are requested to approve our product specification or to transact the approval sheet for product specification, before your ordering.

N16E9.pdf 01.11.26

■Dimensions

1

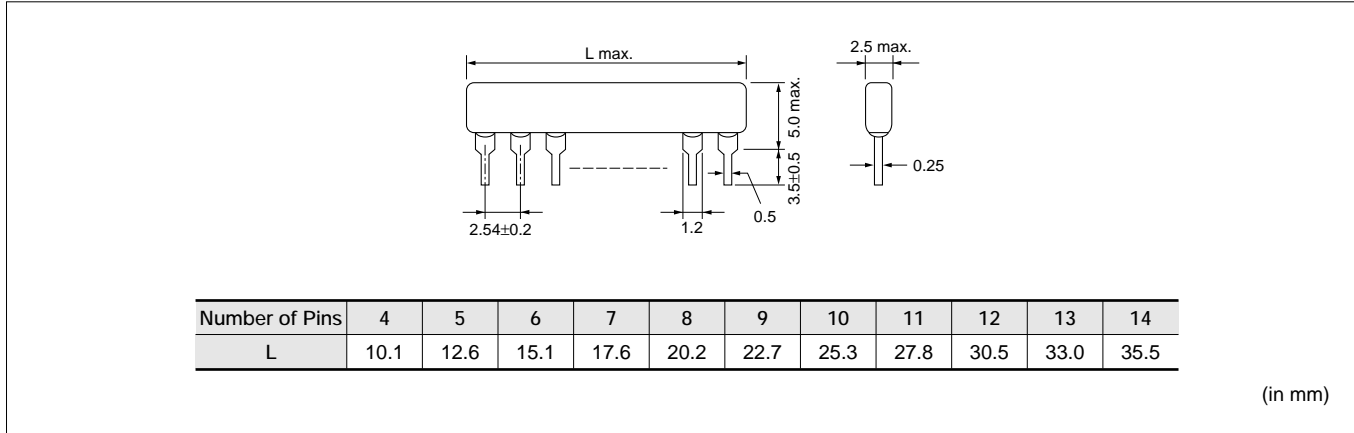

■Marking

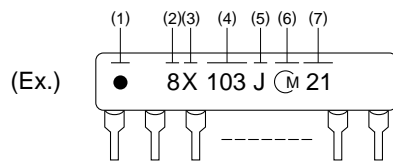

- (1) Pin 1 identification
- (2) Number of Resistors
- (3) Type (Circuit) Designation
- (4) Nominal Resistance Value (3 digits)
- (5) Resistance Tolerance
- (6) Manufacturer's Code
- (7) Date Code (Year, Month)

SIP Resistor Network



Shrink Pitch Resistor Network RGLE Series

2

Features

- The RGLE series comprises standard low profile R-networks with dimensions equivalent to those of a shrink pin pitch IC (height : 5.0mm; pitch : 1.78mm).
- Equivalent dimensions to shrink pin pitch IC facilitates PCB pattern design and enables high density insertion.

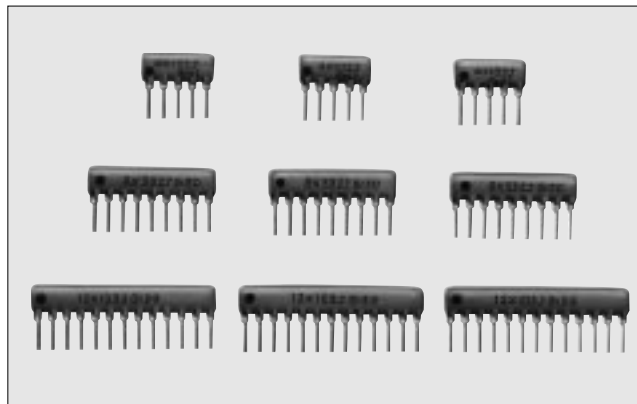

Standard Circuits

Circuit Type	Pull up, Pull down	Isolated	Divider
Type Code	X Type	Y Type	M Type
Circuit	<p>$R_1 = R_2 = \dots = R_n$</p>	<p>$R_1 = R_2 = \dots = R_n$</p>	<p>$R_A = R_1 = R_2 = \dots = R_{\frac{n}{2}}$ $R_B = R_{\frac{n}{2}+1} = R_{\frac{n}{2}+2} = \dots = R_n$</p>
Number of Elements (Pins)	n=3 to 15 (4 to 16)	n=3 to 8 (6 to 16)	n=6 to 12 (even number) (7 to 13)

• Products with other circuits and other element numbers are also available as custom parts.

Rating

	RGLE□X Type	RGLE□Y Type	RGLE□M Type
Power Rating Each Resistor *1	1/10W	1/10W	1/10W
Total Rated Power	1/10W×Number of elements (n)		
Rated Voltage *2	Rated voltage (V) = √Power rating (W) × Nominal resistance value (Ω)		
Standard Resistance	E-12 series *3		
Resistance Range	10Ω to 1MΩ		
Resistance Tolerance *4	J : ±5%, G : ±2% (22Ωmin.)		
Temp. Coeff. of Resistance	±200ppm/°C		
Max. Operating Voltage	100V		
Operating Temperature	-55 to +125°C		

*1 Derating Curve
The rated power per element and the total rated power are derated according to the following curve.

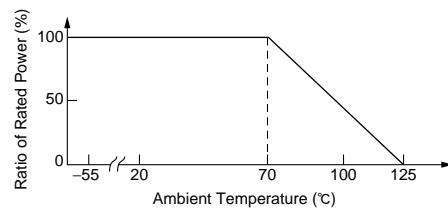

*2 When rated voltage exceeds the max. operating voltage, the max. operating voltage shall be regarded as the rated voltage.

*3 E-12 Standard Values

10, 12, 15, 18, 22, 27,

33, 39, 47, 56, 68, 82

*4 Resistance tolerance : ±1%, T.C.R : ±100ppm/°C is also available.

Please read CAUTION and Notice in this catalog for safety. This catalog has only typical specifications. Therefore you are requested to approve our product specification or to transact the approval sheet for product specification, before your ordering.

N16E9.pdf 01.11.26

■Dimensions

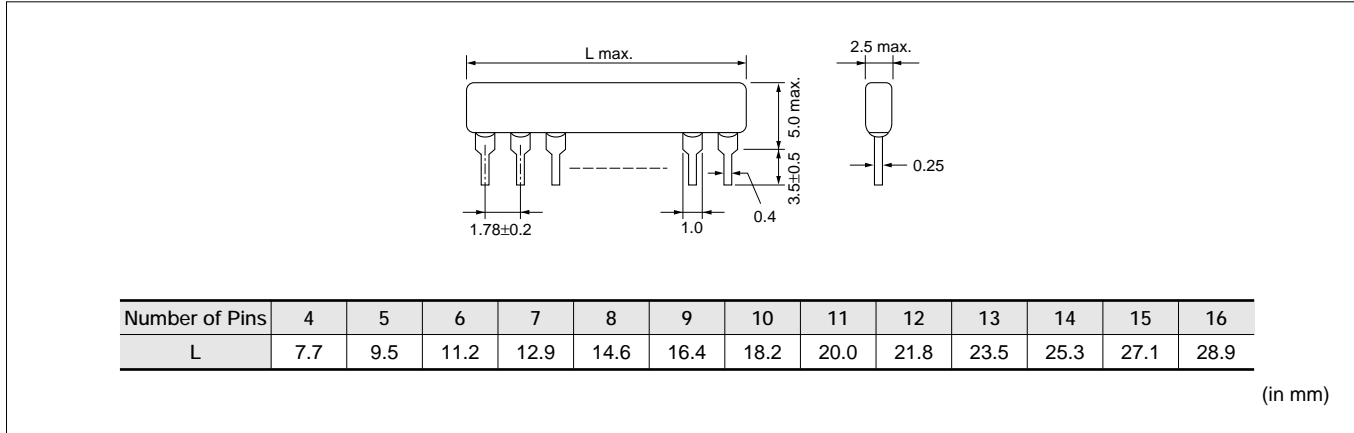

2

■Marking

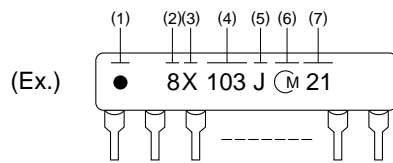

- (1) Pin 1 identification
- (2) Number of Resistors
- (3) Type (Circuit) Designation
- (4) Nominal Resistance Value (3 digits)
- (5) Resistance Tolerance
- (6) Manufacturer's Code
- (7) Date Code (Year, Month)

SIP Resistor Network



High-Power Isolated Resistor Network RGSD Series

■Features

1. Y type is isolated circuit type. And Y type is used as current limiting resistor, level translating resistor.
2. The RGSD series (height : 6.5mm max.; pitch : 2.54mm) is high-power resistor network.
3. Available in the tape packing to meet assembly cost reduction demands.
4. An added feature of the 2.54mm pitch types enables insertion along rows and lines of holes with the same pitch.

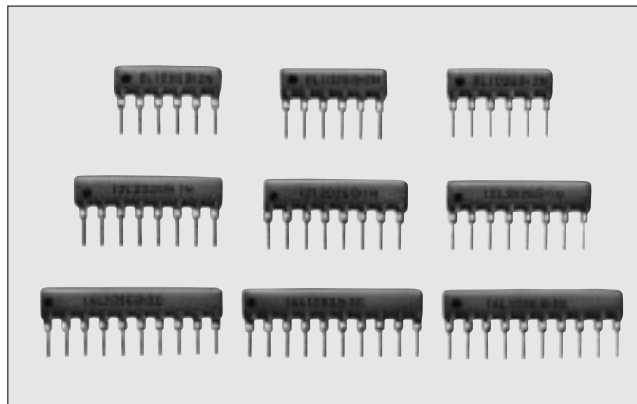

3

■Standard Circuits

Circuit Type	Isolated		Isolated		Isolated			
Type Code	RGSD3Y Type		RGSD4Y Type		RGSD5Y Type			
Circuit								
Circuit Type	Isolated				Isolated			
Type Code	RGSD6Y Type				RGSD7Y Type			
Circuit								

• Products with other circuits and other element numbers are also available as custom parts.



■Rating

	RGSD3Y	RGSD4Y	RGSD5Y	RGSD6Y	RGSD7Y
Power Rating Each Resistor *1	1/4W				
Total Rated Power	1/4W×Number of elements (n)				
Rated Voltage *2	Rated voltage (V) = $\sqrt{\text{Power rating (W)} \times \text{Nominal resistance value } (\Omega)}$				
Standard Resistance	E-12 series *3				
Resistance Range	10Ω to 1MΩ				
Resistance Tolerance *4	J : ±5%, G : ±2% (22Ωmin.)				
Temp. Coeff. of Resistance	±200ppm/°C				
Max. Operating Voltage	100V				
Operating Temperature	-55 to +125°C				

*1 Derating Curve
The rated power per element and the total rated power are derated according to the following curve.

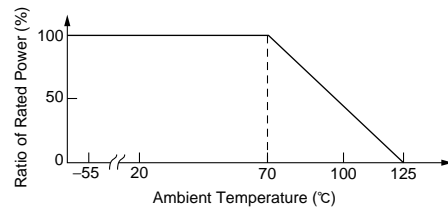

*2 When rated voltage exceeds the max. operating voltage, the max. operating voltage shall be regarded as the rated voltage.

*3 E-12 Standard Values

10, 12, 15, 18, 22, 27, 33, 39, 47, 56, 68, 82

*4 Resistance tolerance : ±1%, T.C.R : ±100ppm/°C is also available.

3

■Dimensions

Number of Pins	6	8	10	12	14
L	15.1	20.2	25.3	30.5	35.5

(in mm)

■Marking

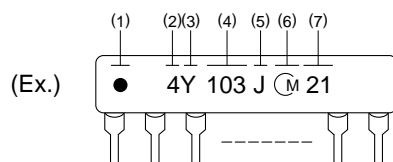

- (1) Pin 1 identification
- (2) Number of Resistors
- (3) Type (Circuit) Designation
- (4) Nominal Resistance Value (3 digits)

- (5) Resistance Tolerance
- (6) Manufacturer's Code
- (7) Date Code (Year, Month)

SIP Resistor Network



R/2R Ladder Resistor Network RGSD Series

■Features

1. These high performance R/2R ladder R-networks enabled by thick film technology have a maximum of 8 bits.
2. The linearity of RGSD series R/2R ladder R-networks is guaranteed. They have the performance of $\pm 1/2\text{LSB}$.
3. This series has a compact design (height : 6.5mm) and is used in AD/DA converters in a variety of digital circuits and equipment.

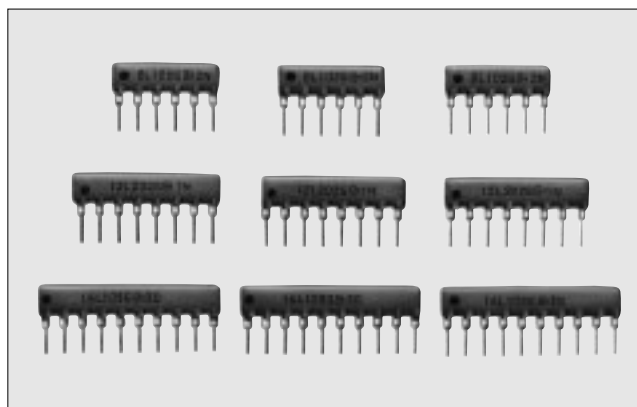

4

■Standard Circuits

Circuit Type	4Bit R/2R Ladder Circuit	5Bit R/2R Ladder Circuit	6Bit R/2R Ladder Circuit
Type Code	RGSD8L Type	RGSD10L Type	RGSD12L Type
Circuit			
Circuit Type	7Bit R/2R Ladder Circuit	8Bit R/2R Ladder Circuit	
Type Code	RGSD14L Type	RGSD16L Type	
Circuit			

Please read CAUTION and Notice in this catalog for safety. This catalog has only typical specifications. Therefore you are requested to approve our product specification or to transact the approval sheet for product specification, before your ordering.

N16E9.pdf 01.11.26

■Rating

	RGSD8L	RGSD10L	RGSD12L	RGSD14L	RGSD16L
Power Rating Each Resistor *	1/32W				
Total Rated Power	1/32W×Number of elements				
Rated Voltage	Rated voltage (V) = $\sqrt{\text{Power rating (W)} \times \text{Nominal resistance value } (\Omega)}$				
(R) Standard Resistance	10, 20, 25, 50 Series				
(R) Resistance Range	100Ω to 100kΩ				
Output Impedance Tolerance	G : ±2%				
Linearity	Bit Error				
	Full Scale Accuracy				
Temperature Coefficient	±3.12%	±1.56%	±0.78%	±0.39%	±0.20%
Operating Temperature	Output Impedance				
	Bit Voltage				
	±200ppm/°C				
	±50ppm/°C				
	-55 to +125°C				

* Derating Curve

The rated power per element and the total rated power are derated according to the following curve.

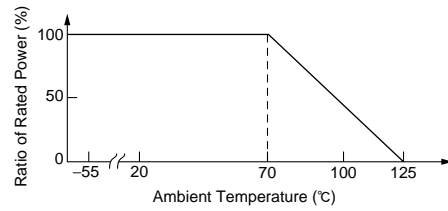

4

■Dimensions

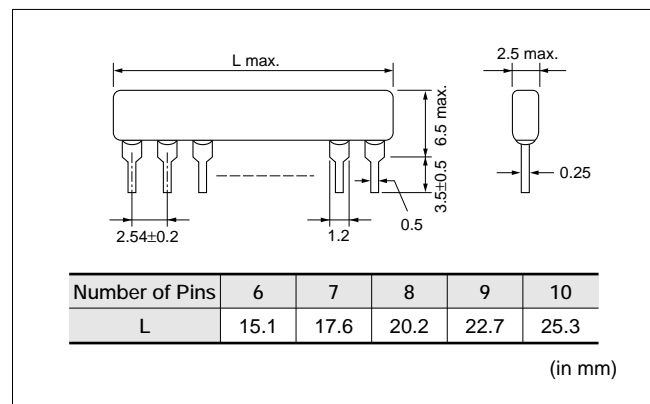

■Measuring Circuit

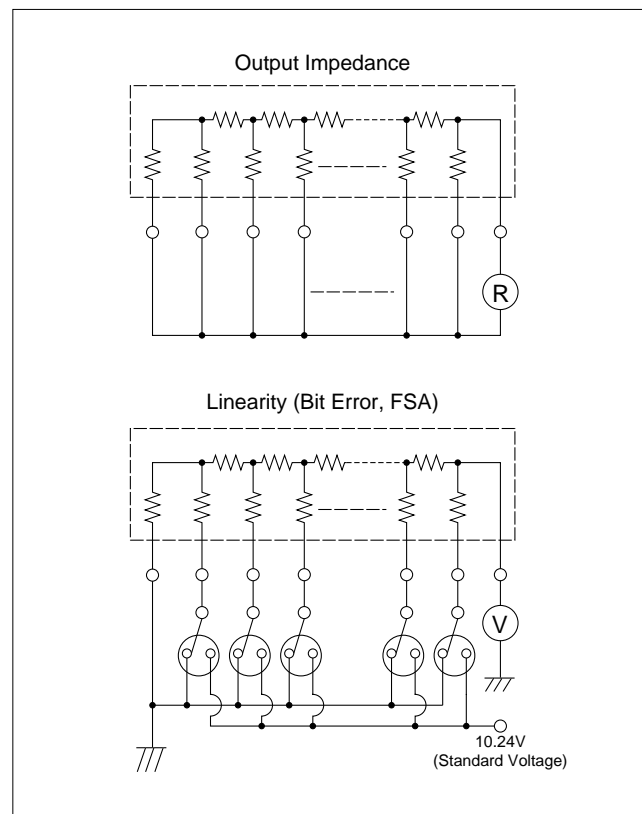

■Marking

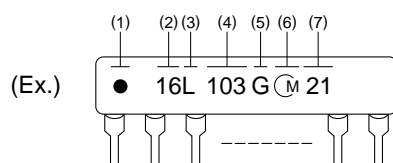

- (1) Pin 1 identification
- (2) Number of Resistors
- (3) Type (Circuit) Designation
- (4) Nominal Resistance Value (3 digits)
- (5) Impedance Tolerance
- (6) Manufacturer's Code
- (7) Date Code (Year, Month)

SIP Resistor Network



Custom Resistor Network Series

■Features

1. The profiles of custom resistor network series products range from high profile (9.0mm) to low profile (5.0mm). All R-network needs can be accommodated.
2. High accuracy performance on resistance tolerance, temperature coefficient etc, is available with high technology and high grade materials.
3. Also, on the relative precision of the performance between resistor elements, the high accuracy is available.

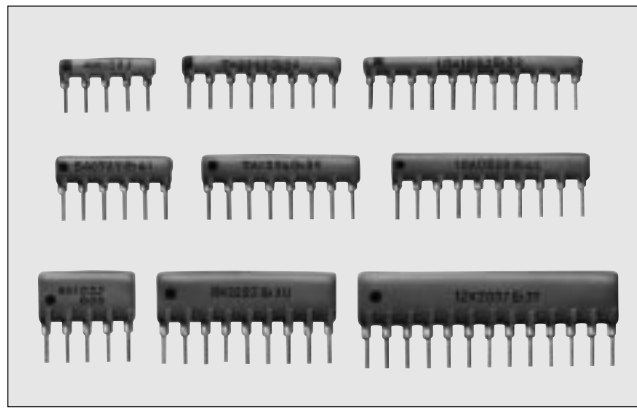

■Standard Series

Series Name	RGHD Series	RGSD Series	RGLD Series	RGLE Series
Dimensions (in mm)				
Standard No. of pins	4 to 14	4 to 14	4 to 14	4 to 16

■Example Custom Circuits

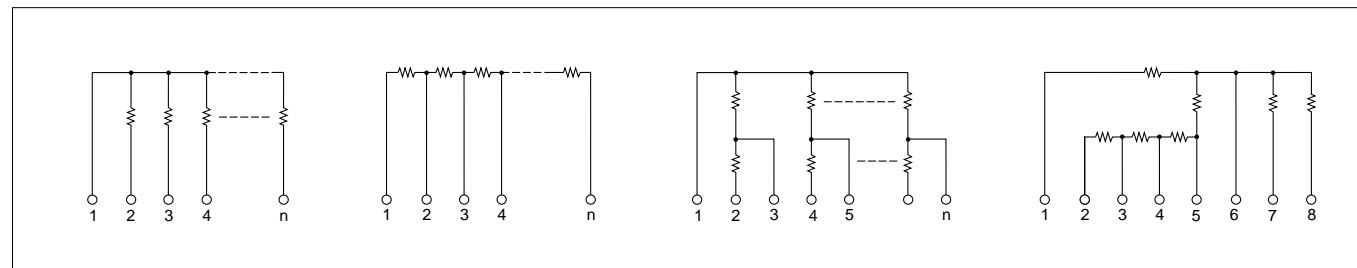

5

■Rating

	RGHD Series	RGSD Series	RGLD Series	RGLE Series
Power Rating Each Resistor *1	to 1/2W	to 1/4W		to 1/8W
Total Rated Power *1	1/5×(Number of pins-1)W	1/8×(Number of pins-1)W		1/16×(Number of pins-1)W
Rated Voltage *2	Rated voltage (V) = √Power rating (W) × Nominal resistance value (Ω)			
Resistance Range	10Ω to 10MΩ			
Resistance Tolerance	D : ±0.5%, (100Ω to 100kΩ), F : ±1%, (47Ω to 220kΩ), ±2% (22Ω Over), J : ±5%			
Resistance Value Ratio	±0.5%, ±1%, ±2% (Per customer's specifications)			
Temp. Coeff. of Resistance	±200ppm/°C (±100ppm/°C is also available)			
Max. Operating Voltage	to 500V			
Operating Temperature	-55 to +125°C			

*1 Derating Curve
The rated power per element and the total rated power are derated according to the following curve.

*2 When rated voltage exceeds the max. operating voltage, the max. operating voltage shall be regarded as the rated voltage.

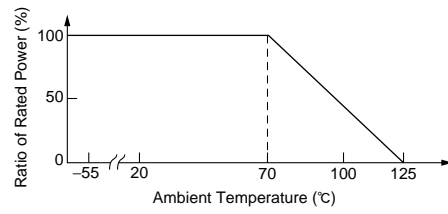

■Dimensions

Series	RGHD	RGSD	RGLD	RGLE
Dimension				
H	9.0	6.5	5.0	5.0
l	3.5±0.5			

Series	Dimension	P	W1	W2
RGLE		1.78	1.0	0.4
Others		2.54	1.2	0.5

Series	Number of Pins	4	5	6	7	8	9	10	11	12	13	14	15	16
		L	RGLE	7.7	9.5	11.2	12.9	14.6	16.4	18.2	20.0	21.8	23.5	25.3
	Others	10.1	12.6	15.1	17.6	20.2	22.7	25.3	27.8	30.5	33.0	35.5	—	—

(in mm)

5

■Marking

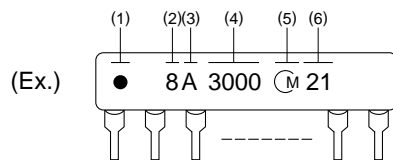

- (1) Pin 1 identification
- (2) Number of Resistors
- (3) Type (Circuit) Designation

- (4) Murata's design No.
- (5) Manufacturer's Code
- (6) Date Code (Year, Month)

Performance and Test Method

Test Item	Performance	Test Method															
DC Resistance value	Within the specified Value	Based on JIS C 5202 5.1. Maximum applied voltage is shown in the table below. <table border="1"> <thead> <tr> <th>Nominal Resistance Range(Ω)</th> <th>Max. Applied Voltage (V)</th> </tr> </thead> <tbody> <tr> <td><100</td> <td>0.3</td> </tr> <tr> <td>100≤R<1k</td> <td>1</td> </tr> <tr> <td>1k≤R<10k</td> <td>3</td> </tr> <tr> <td>10k≤R<100k</td> <td>10</td> </tr> <tr> <td>100k≤R<1M</td> <td>25</td> </tr> <tr> <td>≥1M</td> <td>50</td> </tr> </tbody> </table>	Nominal Resistance Range(Ω)	Max. Applied Voltage (V)	<100	0.3	100≤R<1k	1	1k≤R<10k	3	10k≤R<100k	10	100k≤R<1M	25	≥1M	50	
Nominal Resistance Range(Ω)	Max. Applied Voltage (V)																
<100	0.3																
100≤R<1k	1																
1k≤R<10k	3																
10k≤R<100k	10																
100k≤R<1M	25																
≥1M	50																
Temperature Coefficient of Resistance	Within ±200ppm/°C	Based on JIS C 5202 5.2. Measure after maintaining for over 30 minutes at each stage shown in the table below. Calculation shall be made with the formula shown below. <table border="1"> <thead> <tr> <th>Stage</th> <th>Temp. °C</th> <th>Remarks</th> </tr> </thead> <tbody> <tr> <td>1</td> <td>20±5</td> <td>Standard temp. on low-temp. side</td> </tr> <tr> <td>2</td> <td>-55±3</td> <td></td> </tr> <tr> <td>3</td> <td>20±5</td> <td>Standard temp. on high-temp. side</td> </tr> <tr> <td>4</td> <td>125±3</td> <td></td> </tr> </tbody> </table> <p>R : Actual measured resistance value(Ω) at t °C R₀ : Actual measured resistance value(Ω) at t₀ °C t : Actual measured value of test temperature (°C) t₀ : Actual measured value of standard temperature (°C)</p> $TCR(ppm/°C) = \frac{R-R_0}{R_0} \times \frac{1}{t-t_0} \times 10^6$	Stage	Temp. °C	Remarks	1	20±5	Standard temp. on low-temp. side	2	-55±3		3	20±5	Standard temp. on high-temp. side	4	125±3	
Stage	Temp. °C	Remarks															
1	20±5	Standard temp. on low-temp. side															
2	-55±3																
3	20±5	Standard temp. on high-temp. side															
4	125±3																
Short Time Overload	No noticeable abnormalities in appearance. ΔR : Within ±1.0%	Apply 2.5 times the rated voltage for 5 seconds to each resistor in the network, one at a time. Maintain at room temperature for 30 minutes after remove the voltage, then measure.															
Terminal Strength	Pull Test	Fix the sample body and apply a load of 10N gradually to the pin in the axial direction. Maintain the force for 10 seconds.															
	Bend Test	Bend the pin by 90° in the vertical direction and return to the previous position under applying a load of 5N. And repeat a similar operation in the opposite direction.															
Resistance to Soldering Heat	There shall be neither mechanical damage nor noticeable change in appearance. ΔR : Within ±0.5%	Immerse the pin in melted solder at 260±5°C up to the level of the seating plane of pin for 10±1 second and raise. Then maintain at room temperature for over 1 hour and measure.															
Solderability	Over 95% of the immersed part of the pins is covered with new solder.	Immerse the pin in a flux comprising methanol and resin (weight ratio 25%) up to the level of the seating plane of pin for 5–10seconds. Then, immerse in melted solder at 235±5°C for 2±0.5 second and raise slowly.															
Temperature Cycling	There shall be no mechanical damage. ΔR : Within ±0.5%	Based on JIS C 5202 7.4 After repeating the 5 cycles shown in the table below, maintain at room temperature for 1–2 hours, then measure. <table border="1"> <thead> <tr> <th>Stage</th> <th>1</th> <th>2</th> <th>3</th> <th>4</th> </tr> </thead> <tbody> <tr> <td>Temp.(°C)</td> <td>-55±3</td> <td>Room Temp.</td> <td>125±2</td> <td>Room Temp.</td> </tr> <tr> <td>Time (min.)</td> <td>30</td> <td>2 to 3</td> <td>30</td> <td>2 to 3</td> </tr> </tbody> </table>	Stage	1	2	3	4	Temp.(°C)	-55±3	Room Temp.	125±2	Room Temp.	Time (min.)	30	2 to 3	30	2 to 3
Stage	1	2	3	4													
Temp.(°C)	-55±3	Room Temp.	125±2	Room Temp.													
Time (min.)	30	2 to 3	30	2 to 3													
Humidity	There shall be no noticeable abnormalities in appearance. ΔR : Within ±2.0%	Maintain without load at a constant temperature 40±2°C and constant humidity of 90–95% for 1000±48 hours. Remove and maintain at room temperature for over 1 hour, then measure.															
Humidity Load	There shall be no noticeable abnormalities in appearance. ΔR : Within ±2.0%	Apply the rated voltage intermittently, 1.5 hours on and 0.5 hours off in a chamber at a constant temperature of 40±2°C and constant humidity of 90–95% for 1000±48 hours. Remove and maintain at room temperature for over 1 hour, then measure.															
Load Life	There shall be no noticeable abnormalities in appearance. ΔR : Within ±2.0%	Apply the rated voltage intermittently, 1.5 hours on and 0.5 hours off in a high-temperature chamber at 70±3°C for 1000±48 hours. Remove and maintain at room temperature for over 1 hour, then measure.															

Packaging

1. R-networks are available in two types of taping : 3-pin taping and all-pin taping.
2. 3-pin taping type is applicable to automatic insertion equivalent to 5mm pitch radial taping parts. The tips of untaped terminals are shaped by a V-cut for high accuracy insertion.

■Taping Dimensions

Series	Taping Type Code	Taping Dimensions (in mm)
RGLD	T1	<p>5 – 8 PINS 9 – 10 PINS</p>
	T2	<p>4 – 9 PINS</p>

■Standard Ammo Pack Package Quantity

1000pcs./case

■Package and Marking

- H, L (Height and Length)

Type	Number of pins	H	L
T1	5 to 8	200	40
	9 to 10	290	
T2	4 to 9	210	45

(in mm)

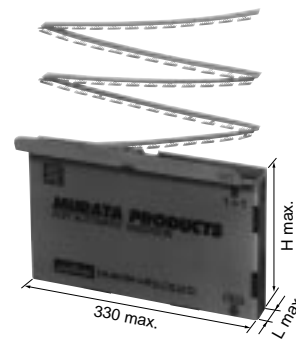

■Minimum Quantity

1000pcs.

Caution/Notice

■ Caution

Use within rated voltage

To avoid resistor burning or breakdown, do not use beyond the rated voltage calculated by taking the square root of the product of rated power and nominal resistance value.

■ Notice

1. Handling after mounting to PCB

Do not bend the product after mounting and soldering the product. If subjected to mechanical stress, the resistor may become damaged.

2. Confirmation of resistor operation in application

Ensure proper performance of the product in your application.

3. Environmental conditions

Do not use or store the product in locations containing corrosive gasses (Cl₂, H₂S, NH₃, SO₂, NO_x, etc.) or having such high humidity as will dew as the product's resin coating does not form a perfect seal.

Please read CAUTION and Notice in this catalog for safety. This catalog has only typical specifications. Therefore you are requested to approve our product specification or to transact the approval sheet for product specification, before your ordering.

N16E9.pdf 01.11.26

ISO 9000 Certifications

Manufacturing plants of these products in this catalog have obtained the ISO9002 quality system certificate.

Plant	Certified Date	Organization	Registration No.
Kanazu Murata Manufacturing Co., Ltd.	July. 1. 1998	UL*	A6734

* UL : Underwriters Laboratories Inc.

⚠Note:

1. Export Control

⌋For customers outside Japan⌋

No muRata products should be used or sold, through any channels, for use in the design, development, production, utilization, maintenance or operation of, or otherwise contribution to (1) any weapons (Weapons of Mass Destruction (nuclear, chemical or biological weapons or missiles) or conventional weapons) or (2) goods or systems specially designed or intended for military end-use or utilization by military end-users.

⌋For customers in Japan⌋

For products which are controlled items subject to the "Foreign Exchange and Foreign Trade Law" of Japan, the export license specified by the law is required for export.

2. Please contact our sales representatives or product engineers before using the products in this catalog for the applications listed below, which require especially high reliability for the prevention of defects which might directly damage a third party's life, body or property, or when one of our products is intended for use in applications other than those specified in this catalog.

- | | |
|-----------------------------|--|
| ① Aircraft equipment | ② Aerospace equipment |
| ③ Undersea equipment | ④ Power plant equipment |
| ⑤ Medical equipment | ⑥ Transportation equipment (vehicles, trains, ships, etc.) |
| ⑦ Traffic signal equipment | ⑧ Disaster prevention / crime prevention equipment |
| ⑨ Data-processing equipment | ⑩ Application of similar complexity and/or reliability requirements to the applications listed above |

3. Product specifications in this catalog are as of November 2001. They are subject to change or our products in it may be discontinued without advance notice. Please check with our sales representatives or product engineers before ordering. If there are any questions, please contact our sales representatives or product engineers.

4. Please read rating and ⚠CAUTION (for storage, operating, rating, soldering, mounting and handling) in this catalog to prevent smoking and/or burning, etc.

5. This catalog has only typical specifications because there is no space for detailed specifications. Therefore, please approve our product specifications or transact the approval sheet for product specifications before ordering.

6. Please note that unless otherwise specified, we shall assume no responsibility whatsoever for any conflict or dispute that may occur in connection with the effect of our and/or a third party's intellectual property rights and other related rights in consideration of your use of our products and/or information described or contained in our catalogs. In this connection, no representation shall be made to the effect that any third parties are authorized to use the rights mentioned above under licenses without our consent.

7. No ozone depleting substances (ODS) under the Montreal Protocol are used in our manufacturing process.

***muRata* Murata Manufacturing Co., Ltd.**

<http://www.murata.com/>

Head Office
1-10-1, Higashi Kotari, Nagaokakyo-shi, Kyoto 617-8555, Japan
Phone: 81-75-951-9111

International Division
3-29-12, Shibuya, Shibuya-ku, Tokyo 150-0002, Japan
Phone: 81-3-5469-6123 Fax: 81-3-5469-6155 E-mail: intl@murata.co.jp