

FEATURES

- Supports DOCSIS Standard for Reverse Path Transmission
- Gain Programmable in 6.02 dB Steps over a 48.16 dB Range
- Low Distortion at 60 dBmV Output
 - 63 dBc SFDR at 21 MHz
 - 57 dBc SFDR at 42 MHz
- Output Noise Level
 - 47 dBmV in 160 kHz
- Maintains 75 Ω Output Impedance
- Transmit Enable and Transmit Disable Modes
- Upper Bandwidth: 160 MHz (Full Gain Range)
- 5 V Supply Operation
- Supports SPI Interfaces

APPLICATIONS

- Gain-Programmable Line Driver
- DOCSIS High-Speed Data Modems
- Interactive Cable Set-Top Boxes
- PC Plug-in Cable Modems
- General-Purpose Digitally Controlled Variable Gain Block

GENERAL DESCRIPTION

The AD8327 is a low-cost, digitally controlled, variable gain amplifier optimized for coaxial line driving applications such as cable modems that are designed to the MCNS-DOCSIS upstream standard. An 8-bit serial word determines the desired output gain over a 48.16 dB range resulting in gain changes of 6.02 dB/major carry.

The AD8327 comprises a digitally controlled variable attenuator of 0 dB to -48.16 dB, which is preceded by a low noise, fixed gain buffer and followed by a low distortion, high power amplifier. The AD8327 accepts a differential or single-ended input signal. The output is specified for driving a 75 Ω load, such as coaxial cable.

Distortion performance of -63 dBc is achieved with an output level up to 60 dBmV at 21 MHz bandwidth. A key performance and cost advantage of the AD8327 results from the ability to maintain a constant 75 Ω output impedance during Transmit Enable and Transmit Disable conditions. In addition, this device has a sleep mode function that reduces the quiescent current to 5 mA.

The AD8327 is packaged in a low-cost 20-lead TSSOP, operates from a single 5 V supply, and has an operational temperature range of -40°C to +85°C.

REV. 0

Information furnished by Analog Devices is believed to be accurate and reliable. However, no responsibility is assumed by Analog Devices for its use, nor for any infringements of patents or other rights of third parties that may result from its use. No license is granted by implication or otherwise under any patent or patent rights of Analog Devices.

FUNCTIONAL BLOCK DIAGRAM

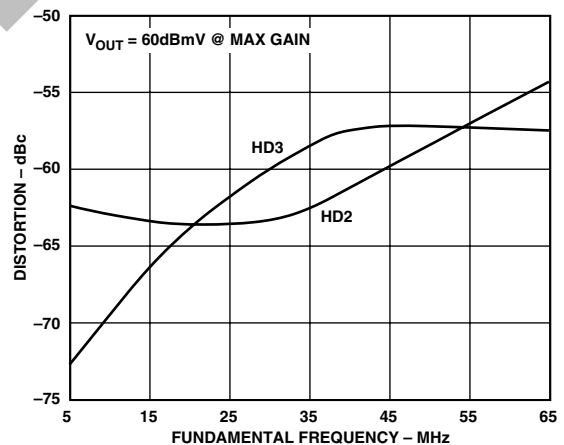
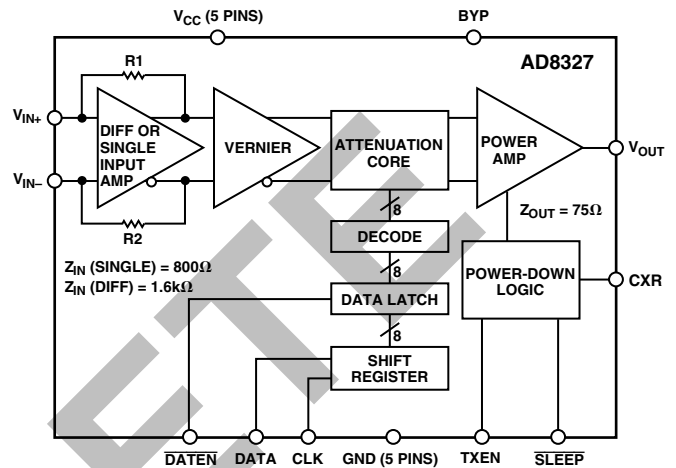

Figure 1. Harmonic Distortion vs. Frequency

AD8327—SPECIFICATIONS (T_A = 25°C, V_S = 5 V, R_L = 75 Ω, V_{IN(DIFFERENTIAL)} = 30 dBmV)

Parameter	Conditions	Min	Typ	Max	Unit
INPUT CHARACTERISTICS					
Specified AC Voltage	P _{OUT} = 60 dBmV, Max Gain		30		dBmV
Noise Figure	Max Gain, f = 10 MHz		13.2		dB
Input Resistance	Single-Ended Input		800		Ω
	Differential Input		1600		Ω
Input Capacitance			2		pF
GAIN CONTROL INTERFACE					
Gain Range		47.16	48.16	49.16	dB
Maximum Gain	Gain Code = 10000000 (128 Decimal)	29	30	31	dB
Minimum Gain	Gain Code = 00000000 (0 Decimal)	-19.16	-18.16	-17.16	dB
Gain Scaling Factor			6.02		dB/Major Carry
OUTPUT CHARACTERISTICS					
Bandwidth (-3 dB)	All Gain Codes		160		MHz
Bandwidth Roll-Off	f = 65 MHz		0.4		dB
Bandwidth Peaking	All Gain Codes		0		dB
Output Noise Spectral Density	Max Gain, f = 10 MHz		-32		dBmV in 160 kHz
	Min Gain, f = 10 MHz		-47		dBmV in 160 kHz
	Transmit Disable Mode (TXEN = 0), f = 10 MHz		-66		dBmV in 160 kHz
1 dB Compression Point	Max Gain, f = 10 MHz		14.8		dBm
Differential Output Impedance	Transmit Enable (TXEN = 1) and Transmit Disable Mode (TXEN = 0)		75 ± 20%		Ω
OVERALL PERFORMANCE					
Second Order Harmonic Distortion	f = 21 MHz, V _{OUT} = 60 dBmV @ Max Gain		-63		dBc
	f = 42 MHz, V _{OUT} = 60 dBmV @ Max Gain		-61		dBc
	f = 65 MHz, V _{OUT} = 60 dBmV @ Max Gain		-54		dBc
Third Order Harmonic Distortion	f = 21 MHz, V _{OUT} = 60 dBmV @ Max Gain		-63		dBc
	f = 42 MHz, V _{OUT} = 60 dBmV @ Max Gain		-57		dBc
	f = 65 MHz, V _{OUT} = 60 dBmV @ Max Gain		-57		dBc
Adjacent Channel Power	Adjacent Channel Width = Transmit Channel Width = 160 K _{SYM/SEC}		-62		dBc
Gain Linearity Error	f = 10 MHz, Code to Code		±0.25		dB
Output Settling					
Due to Gain Change (T _{GS})	Min to Max Gain		60		ns
Due to Input Change	Max Gain, V _{IN} = 30 dBmV		30		ns
Isolation in Transmit Disable Mode	Max Gain, TXEN = 0 V, f = 42 MHz, V _{IN} = 30 dBmV		-52		dBc
POWER CONTROL					
Transmit Enable Settling Time (T _{ON}) ¹	Max Gain, V _{IN} = 0 V		300		ns
Transmit Disable Settling Time (T _{OFF}) ¹	Max Gain, V _{IN} = 0 V		40		ns
Transmit Enable Settling Time (T _{ON}) ²	Max Gain, V _{IN} = 0 V		2		μs
Transmit Disable Settling Time (T _{OFF}) ²	Max Gain, V _{IN} = 0 V		1.7		μs
Between Burst Transients ²	Equivalent Output = 31 dBmV		3		mV p-p
	Equivalent Output = 60 dBmV		25		mV p-p
Ramp Setting ²			2		μs
POWER SUPPLY					
Operating Range		4.75	5	5.25	V
Quiescent Current	Transmit Enable Mode (TXEN = 1) @ Dec 128	75	105	135	mA
	Transmit Enable Mode (TXEN = 1) @ Dec 0	40	60	80	mA
	Transmit Disable Mode @ All Gain Codes	10	15	20	mA
	Sleep Mode @ All Gain Codes	3	5	7	mA
OPERATING TEMPERATURE RANGE					
		-40		+85	°C

NOTES

¹For Transmit Enable or Transmit Disable transitions using a 0 pF capacitor (at CXR pin) to ground.

²For Transmit Enable or Transmit Disable transitions using a 100 pF capacitor (at CXR pin) to ground.

Specifications subject to change without notice.

LOGIC INPUTS (TTL/CMOS-Compatible Logic) ($\overline{\text{DATEN}}$, CLK, SDATA, TXEN, $\overline{\text{SLEEP}}$, $V_{CC} = 5\text{ V}$: Full Temperature Range)

Parameter	Min	Typ	Max	Unit
Logic "1" Voltage	2.1		5.0	V
Logic "0" Voltage	0		0.8	V
Logic "1" Current ($V_{INL} = 5\text{ V}$) CLK, SDATA, $\overline{\text{DATEN}}$	0		20	nA
Logic "0" Current ($V_{INL} = 0\text{ V}$) CLK, SDATA, $\overline{\text{DATEN}}$	-600		-100	nA
Logic "1" Current ($V_{INL} = 5\text{ V}$) TXEN	50		190	μA
Logic "0" Current ($V_{INL} = 0\text{ V}$) TXEN	-250		-30	μA
Logic "1" Current ($V_{INL} = 5\text{ V}$) $\overline{\text{SLEEP}}$	50		190	μA
Logic "0" Current ($V_{INL} = 0\text{ V}$) $\overline{\text{SLEEP}}$	-250		-30	μA

TIMING REQUIREMENTS (Full Temperature Range, $V_{CC} = 5\text{ V}$, $t_r = t_f = 4\text{ ns}$, $f_{CLK} = 8\text{ MHz}$ unless otherwise noted.)

Parameter	Min	Typ	Max	Unit
Clock Pulsewidth (t_{WH})	16.0			ns
Clock Period (t_c)	32.0			ns
Setup Time SDATA vs. Clock (t_{DS})	5.0			ns
Setup Time $\overline{\text{DATEN}}$ vs. Clock (t_{ES})	15.0			ns
Hold Time SDATA vs. Clock (t_{DH})	5.0			ns
Hold Time $\overline{\text{DATEN}}$ vs. Clock (t_{EH})	3.0			ns
Input Rise and Fall Times, SDATA, $\overline{\text{DATEN}}$, Clock (t_r, t_f)			10	ns

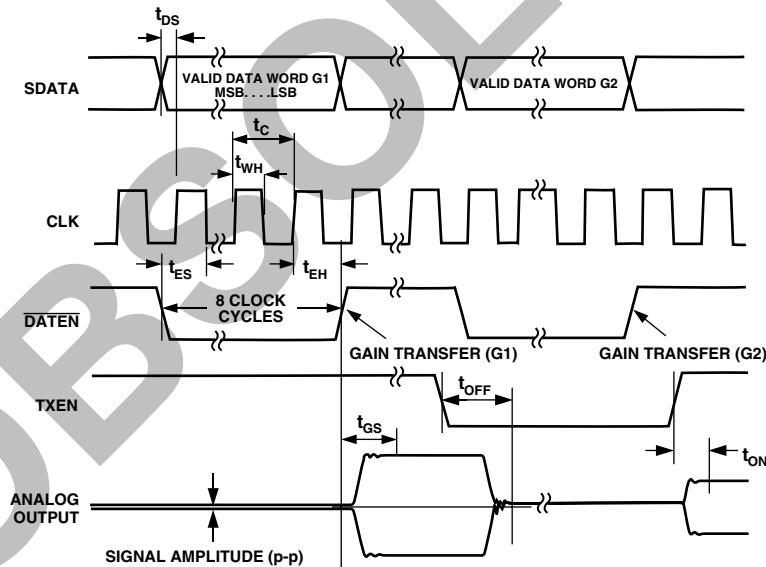

Figure 2. Serial Interface Timing

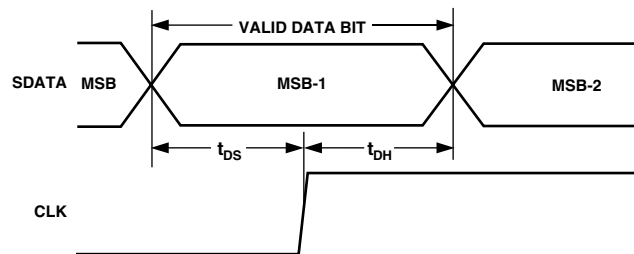

Figure 3. SDATA Timing

AD8327

ABSOLUTE MAXIMUM RATINGS*

Supply Voltage +V _S	
Pins 4, 6, 11, 12, 16	6 V
Input Voltages	
Pins 17, 18	±0.5 V
Pins 1, 2, 3, 19, 20	-0.8 V to +5.5 V
Internal Power Dissipation	
TSSOP	810 mW
Operating Temperature Range	-40°C to +85°C
Storage Temperature Range	-65°C to +150°C
Lead Temperature, Soldering 60 seconds	300°C

*Stresses above those listed under Absolute Maximum Ratings may cause permanent damage to the device. This is a stress rating only; functional operation of the device at these or any other conditions above those indicated in the operational section of this specification is not implied. Exposure to absolute maximum rating conditions for extended periods may affect device reliability.

PIN CONFIGURATION

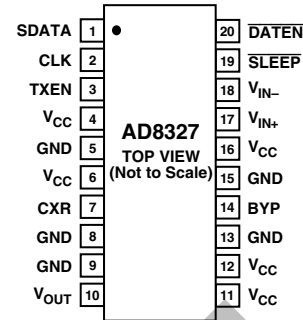

PIN FUNCTION DESCRIPTIONS

Pin No.	Mnemonic	Description
1	SDATA	Serial Data Input. This digital input allows for an 8-bit serial (gain) word to be loaded into the internal register with the MSB (Most Significant Bit) first.
2	CLK	Clock Input. The clock port controls the serial attenuator data transfer rate to the 8-bit master-slave register. A Logic 0-to-1 transition latches the data bit and a 1-to-0 transfers the data bit to the slave. This requires the input serial data word to be valid at or before this clock transition.
3	TXEN	Logic “0” disables transmission. Logic “1” enables transmission.
4, 6, 11, 12, 16	V _{CC}	Common Positive External Supply Voltage. A 0.1 μF capacitor must decouple each pin.
5, 8, 9, 13, 15	GND	Common External Ground Reference
7	CXR	Transmit Enable/Disable Timing Capacitor. This pin is decoupled with a 100 pF capacitor to GND.
10	V _{OUT}	Output Signal
14	BYP	Internal Bypass. This pin must be externally ac-coupled (0.1 μF capacitor).
17	V _{IN+}	Noninverting Input. DC-biased to approximately V _{CC} /2. Should be ac-coupled with a 0.1 μF capacitor.
18	V _{IN-}	Inverting Input. DC-biased to approximately V _{CC} /2. Should be ac-coupled with a 0.1 μF capacitor.
19	$\overline{\text{SLEEP}}$	Low Power Sleep Mode. Logic 0 enables Sleep mode, where Z _{OUT} goes to 200 Ω and supply current is reduced to 5 mA. Logic 1 enables normal operation.
20	$\overline{\text{DATEN}}$	Data Enable Low Input. This port controls the 8-bit parallel data latch and shift register. A Logic 0-to-1 transition transfers the latched data to the attenuator core (updates the gain) and simultaneously inhibits serial data transfer into the register. A 1-to-0 transition inhibits the data latch (holds the previous gain state) and simultaneously enables the register for serial data load.

ORDERING GUIDE

Model	Temperature Range	Package Description	θ _{JA}	Package Option
AD8327ARU	-40°C to +85°C	20-Lead TSSOP	85°C/W*	RU-20
AD8327ARU-REEL	-40°C to +85°C	20-Lead TSSOP	85°C/W*	RU-20
AD8327-EVAL		Evaluation Board		

*Thermal Resistance measured on SEMI standard 4-layer board.

CAUTION

ESD (electrostatic discharge) sensitive device. Electrostatic charges as high as 4000 V readily accumulate on the human body and test equipment and can discharge without detection. Although the AD8327 features proprietary ESD protection circuitry, permanent damage may occur on devices subjected to high-energy electrostatic discharges. Therefore, proper ESD precautions are recommended to avoid performance degradation or loss of functionality.



Typical Performance Characteristics—AD8327

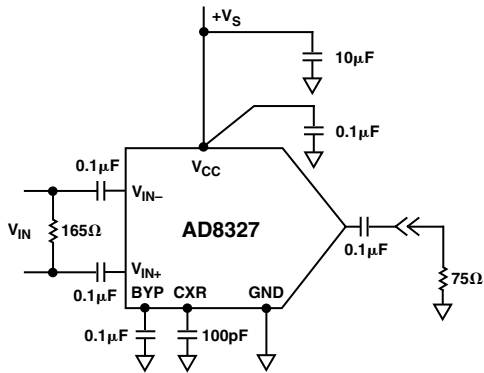

TPC 1. Basic Test Circuit

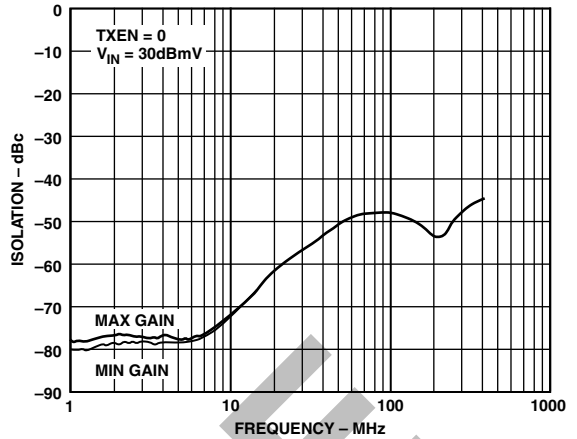

TPC 4. Isolation in Transmit Disable Mode vs. Frequency

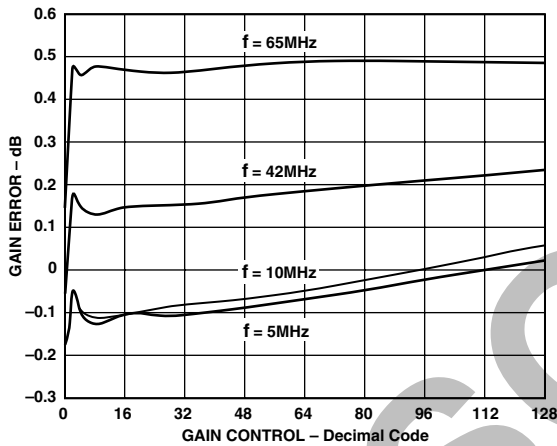

TPC 2. Gain Error vs. Gain Control

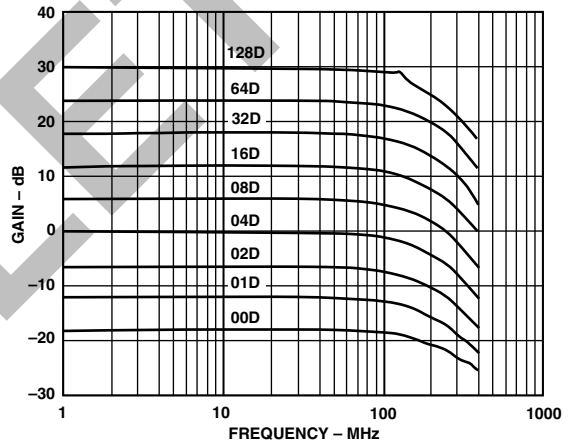

TPC 5. AC Response

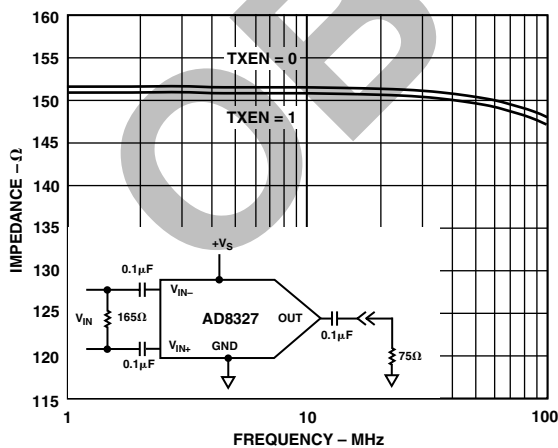

TPC 3. Input Impedance vs. Frequency

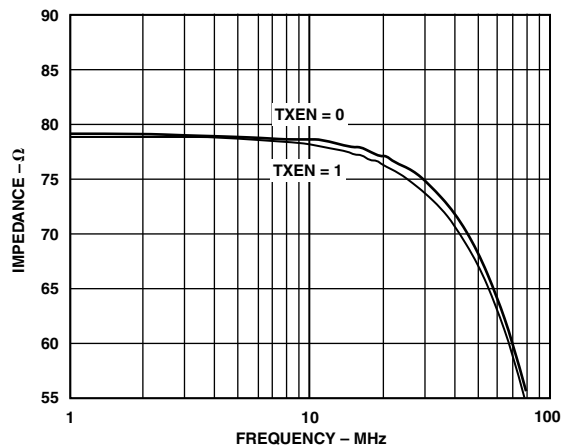

TPC 6. Output Impedance vs. Frequency

AD8327

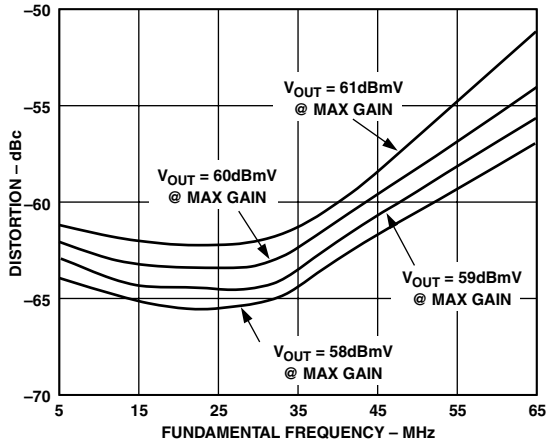

TPC 7. Second Order Harmonic Distortion vs. Frequency for Various Output Levels

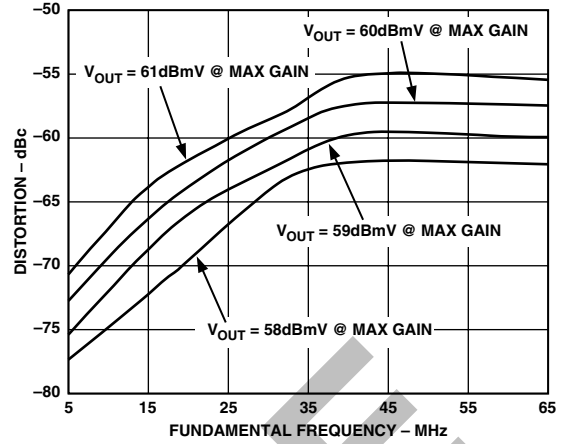

TPC 10. Third Order Harmonic Distortion vs. Frequency for Various Output Levels

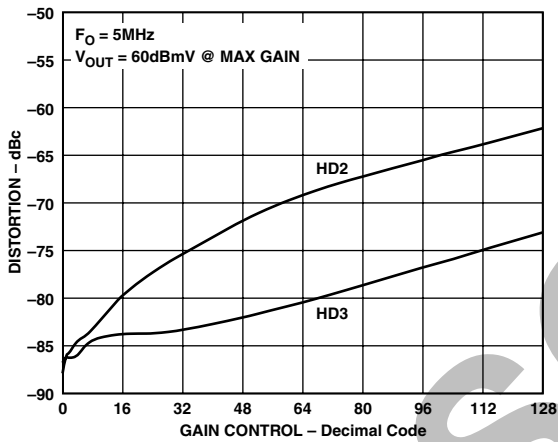

TPC 8. Harmonic Distortion vs. Gain Control

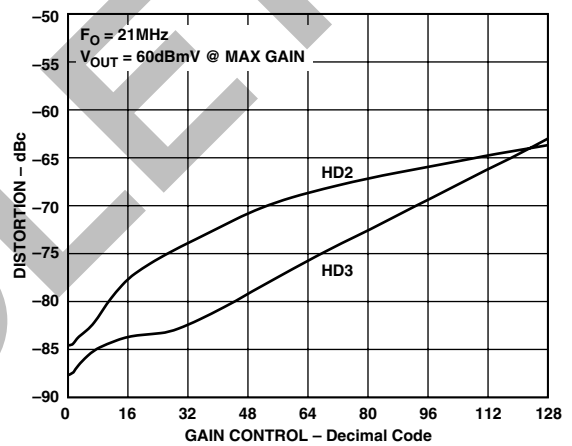

TPC 11. Harmonic Distortion vs. Gain Control

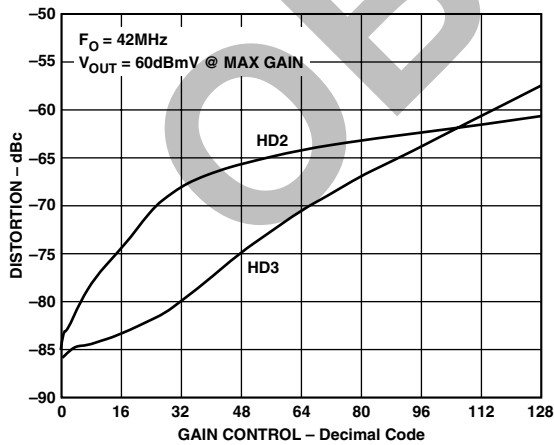

TPC 9. Harmonic Distortion vs. Gain Control

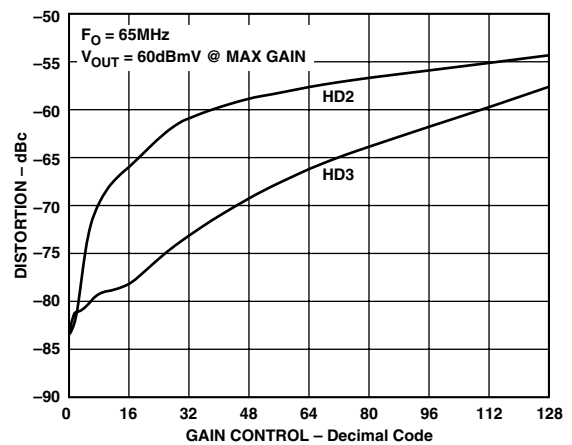

TPC 12. Harmonic Distortion vs. Gain Control

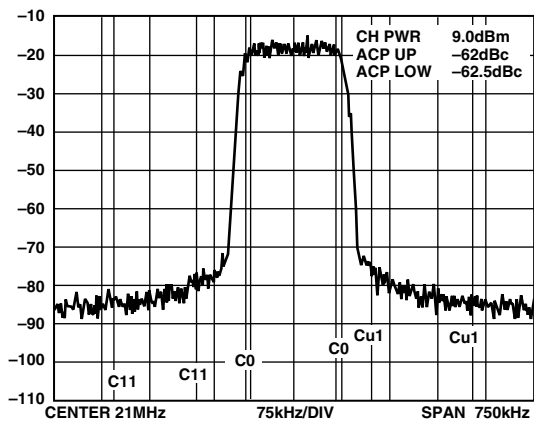

TPC 13. Adjacent Channel Power

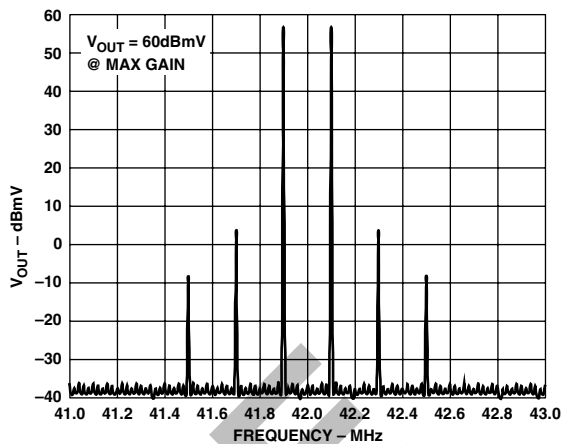

TPC 16. Two-Tone Intermodulation Distortion

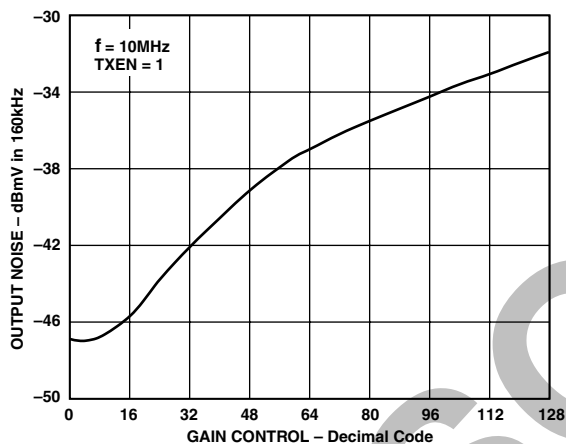

TPC 14. Output Referred Noise vs. Gain Control

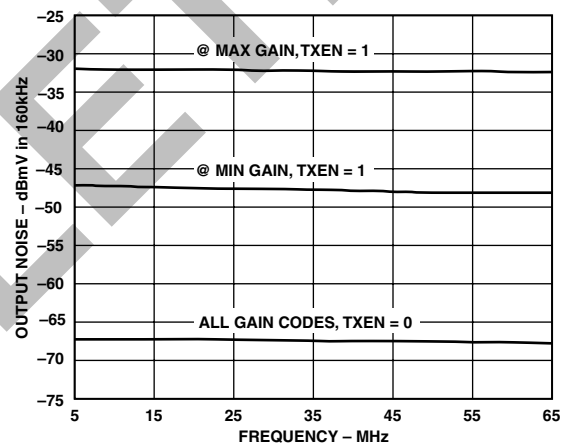

TPC 17. Output Referred Noise vs. Frequency for Various Gain Codes

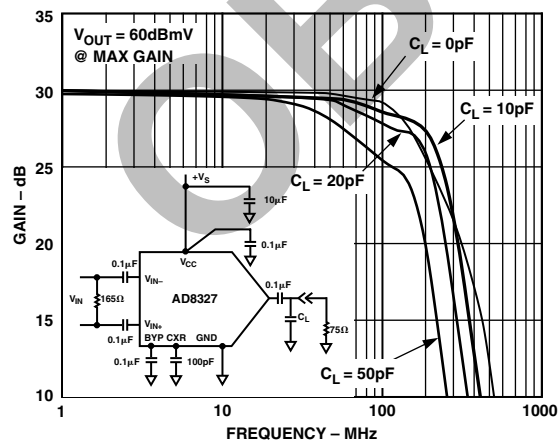

TPC 15. AC Response for Various Capacitor Loads

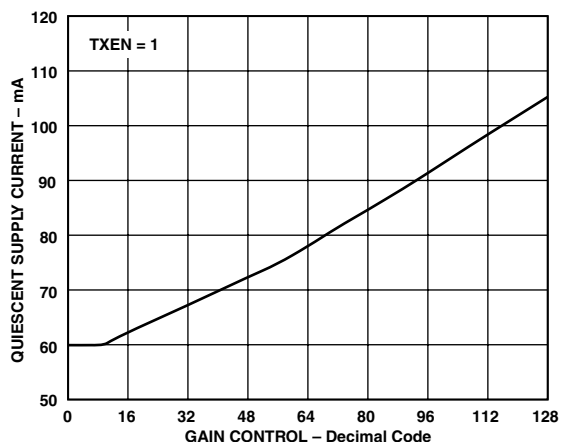

TPC 18. Supply Current vs. Gain Code

AD8327

APPLICATIONS

General Application

The AD8327 is primarily intended for use as the upstream power amplifier (PA), also known as a line driver, in DOCSIS (Data Over Cable Service Interface Specification) certified cable modems and CATV set-top boxes. The upstream signal is either a QPSK or QAM signal generated by a DSP, a dedicated QPSK/QAM modulator, or a DAC.

In all cases the signal must be low-pass filtered before being applied to the PA in order to filter out-of-band noise and higher order harmonics from the amplified signal. Due to the varying distances between the cable modem and the headend, the upstream PA must be capable of varying the output power by applying gain or attenuation. The varying output power of the AD8327 ensures that the signal from the cable modem will have the proper level once it arrives at the headend. The upstream signal path commonly includes a diplexer and cable splitters. The AD8327 has been designed to overcome losses associated with these passive components in the upstream cable path.

Circuit Description

The AD8327 is composed of three analog functions in the power-up or forward mode. The input amplifier (preamp) can be used single-ended or differentially. If the input is used in the differential configuration, it is imperative that the input signals be 180 degrees out of phase and of equal amplitude. The preamp stage drives a DAC, which provides the AD8327's attenuation (eight bits or 48.16 dB). The signals in the preamp and DAC gain blocks are differential to improve the PSRR and linearity. A differential current is fed from the DAC into the output stage,

which amplifies these currents to the appropriate levels necessary to drive a 75 Ω load. The output stage maintains 75 Ω output impedance, eliminating the need for external matching resistors.

SPI Programming and Gain Adjustment

The AD8327 is controlled through a serial peripheral interface (SPI) of three digital data lines: CLK, DATEN, and SDATA. Changing the gain requires eight bits of data to be streamed into the SDATA port. The sequence of loading the SDATA register begins on the falling edge of the DATEN pin, which activates the CLK line. With the CLK line activated, data on the SDATA line is clocked into the serial shift register, Most Significant Bit (MSB) first, on the rising edge of the CLK pulses. The 8-bit data word is latched into the attenuator core on the rising edge of the DATEN line. This provides control over the changes in the output signal level. The serial interface timing for the AD8327 is shown in Figures 2 and 3. The programmable gain range of the AD8327 is -18.16 dB to +30 dB with steps of 6.02 dB per major carry. This provides a total gain range of 48.16 dB. The AD8327 was characterized with a TOKO transformer (TOKO#617DB-A0070) on the input, and the stated gain values account for the losses due to the transformer. Table I shows the possible gain states.

Input Bias, Impedance, and Termination

The V_{IN+} and V_{IN-} inputs have a dc bias level of $V_{CC}/2$, therefore the input signal should be ac-coupled using 0.1 μ F capacitors as seen in the typical application circuit (see Figure 4). The differential input impedance of the AD8327 is approximately 1.6 k Ω , while the single-ended input impedance is 800 Ω .

Table I. Gain States

Decimal Code	Bit 7	Bit 6	Bit 5	Bit 4	Bit 3	Bit 2	Bit 1	Bit 0	Gain
0	0	0	0	0	0	0	0	0	-18.16
1	0	0	0	0	0	0	0	1	-12.14
2	0	0	0	0	0	0	1	0	-6.12
4	0	0	0	0	0	1	0	0	-0.10
8	0	0	0	0	1	0	0	0	5.92
16	0	0	0	1	0	0	0	0	11.94
32	0	0	1	0	0	0	0	0	17.96
64	0	1	0	0	0	0	0	0	23.98
128	1	0	0	0	0	0	0	0	30

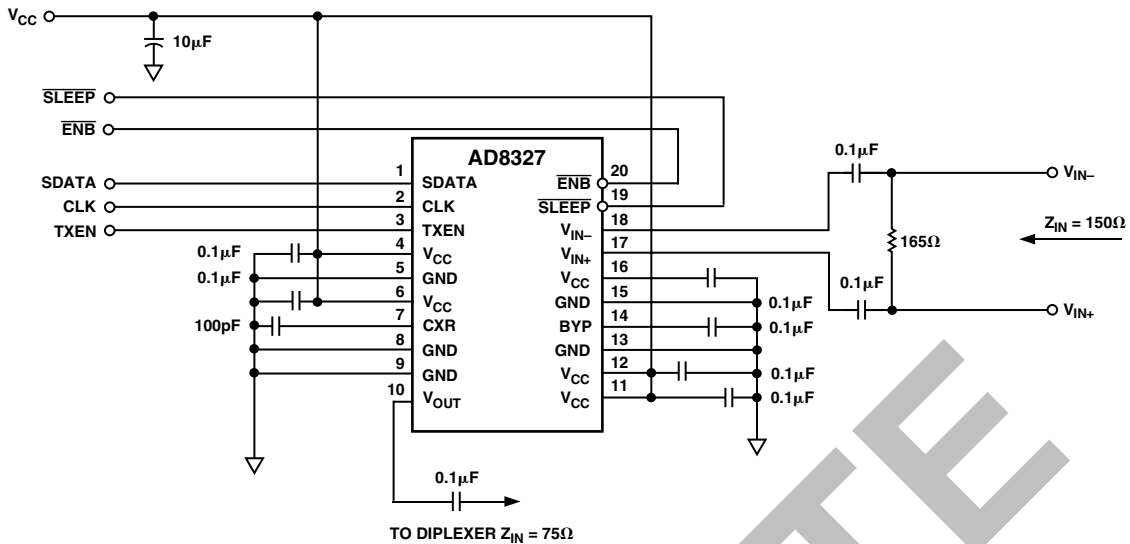

Figure 4. Typical Application Circuit

Single-Ended Inverting Input

When operating the AD8327 in a single-ended input mode V_{IN+} and V_{IN-} should be terminated as illustrated in Figure 5. On the AD8327 evaluation boards, this termination method requires the removal of R13–R16 and R20, as well as the addition of a 0 Ω jumper at R17. Table II shows the correct values for R11 and R12 for some common input configurations. Other input impedance configurations may be accommodated using the equations in Figure 5. The inverting and noninverting inputs of the AD8327 must be balanced for all input configurations

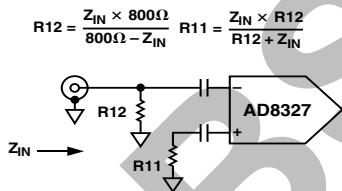

Figure 5. Single-Ended Inverting Input

Differential Input from Single-Ended Source

The default configuration of the evaluation board implements a differential signal drive from a single-ended signal source. A TOKO 1:1 transformer is included on the board for this purpose (T3). Enabling the evaluation board for single to differential input conversion requires R11–R12 and R16–R17 to be removed, and 0 Ω jumpers must be installed on the placeholders for R14, R15, and R20. Table II provides typical R13 values for common input configurations. Other input impedances may be calculated using the equation in Figure 6. Refer to Figure 10 for evaluation board schematic. To utilize the transformer for converting a single-ended source into a differential signal, the input signal must be applied to V_{IN+} .

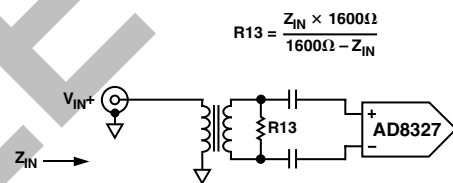

Figure 6. Single to Differential Input

Differential Signal Source

The AD8327 evaluation board is also capable of accepting a differential input signal. Remove R11–R12, R14–R15, and R20, and place 0 Ω jumpers for R16–R17. See Table II for common values of R13, or calculate other input configurations using the equation in Figure 7.

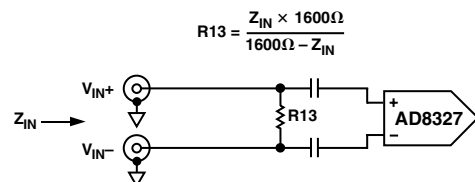

Figure 7. Differential Input

Output Bias, Impedance, and Termination

The output of the AD8327 has a dc bias level of approximately $V_{CC}/2$; therefore, it should be ac-coupled before being applied to the load. The output impedance of the AD8327 is internally maintained at 75 Ω , regardless of whether the amplifier is in transmit enable or transmit disable mode. This eliminates the need for external back termination resistors. If the output signal is being evaluated using standard 50 Ω test equipment, a minimum loss 75 Ω to 50 Ω pad must be used to provide the test circuit with the proper impedance match.

AD8327

Table II. Common Input Terminations

Differential Input Termination			
ZIN (Ω)	R11	R12	R13 (Ω)
50	Open	Open	52.1
75	Open	Open	78.7
100	Open	Open	107
150	Open	Open	165
Single-Ended Input Termination			
ZIN (Ω)	R11 (Ω)	R12 (Ω)	R13
50	25.5	53.6	Open
75	39.2	82.5	Open

Power Supply

The 5 V supply should be delivered to each of the V_{CC} pins via a low impedance power bus to ensure that each pin is at the same potential. The power bus should be decoupled to ground using a 10 μ F tantalum capacitor located close to the AD8327ARU. In addition to the 10 μ F capacitor, each V_{CC} pin should be individually decoupled to ground with 0.1 μ F ceramic chip capacitors located close to the pins. The bypass pin, labeled BYP (Pin 14), should also be decoupled with a 0.1 μ F capacitor. The PCB should have a low impedance ground plane covering all unused portions of the board, except in areas of the board where input and output traces are in close proximity to the AD8327. All AD8327 ground pins must be connected to the ground plane to ensure proper grounding of all internal nodes.

CXR Pin

The AD8327 features internal circuitry that controls burst transients. This feature uses a 100 pF capacitor connected to Pin 7 of the AD8327, to slow down the turn-on transient and minimize between-burst transients.

Signal Integrity Layout Considerations

Careful attention to printed circuit board layout details will prevent problems due to board parasitics. Proper RF design techniques are mandatory. The differential input and output traces should be kept as short as possible. It is also critical that all differential signal paths be symmetrical in length and width. In addition, the input and output traces should be kept far apart, to minimize coupling (crosstalk) through the board. Following these guidelines will optimize the overall performance of the AD8327 in all applications.

Initial Power-Up

When the supply voltage is first applied to the AD8327, the gain of the amplifier is initially set to gain code 0. As power is first applied to the amplifier, the TXEN pin should be held low (Logic 0) to prevent forward signal transmission. After power has been applied to the amplifier, the gain can be set to the desired level by following the procedure provided in the SPI Programming and Gain Adjustment section. The TXEN pin can then be brought from Logic 0 to Logic 1, enabling forward signal transmission at the desired gain level.

Asynchronous Power-Down

The asynchronous TXEN pin is used to place the AD8327 into between-burst mode, while maintaining a differential output impedance of 75 Ω . Applying Logic 0 to the TXEN pin activates the on-chip reverse amplifier, providing an 86% reduction in consumed power. For 5 V operation, the supply current is typically reduced from 105 mA to 15 mA. In this mode of operation, between-burst noise is minimized and the amplifier can no longer transmit in the upstream direction. In addition to the TXEN pin, the AD8327 also incorporates an asynchronous SLEEP pin, which may be used to further reduce the supply current to approximately 5 mA. Applying Logic 0 to the SLEEP pin places the amplifier into SLEEP mode. Transitioning into or out of SLEEP mode may result in a transient voltage at the output of the amplifier.

Distortion, Adjacent Channel Power, and DOCSIS

In order to deliver the DOCSIS required +58 dBmV of QPSK signal and +55 dBmV of 16 QAM signal, the PA is required to deliver up to +60 dBmV and +57 dBmV respectively. This level is required to compensate for losses associated with the diplex filter or other passive components that may be included in the upstream path of cable modems or set-top boxes. It should be noted that the AD8327 was characterized with the TOKO 617DB-A0070 transformer on the input to generate a differential input signal. TPC 7 and TPC 10 show the AD8327 second and third order harmonic distortion performance versus fundamental frequency for various output power levels. These figures are useful for determining the in-band harmonic levels from 5 MHz to 65 MHz. Harmonics higher in frequency (above 42 MHz for DOCSIS and above 65 MHz for EuroDOCSIS) will be sharply attenuated by the low-pass filter function of the diplexer.

Another measure of signal integrity is adjacent channel power, commonly referred to as ACP. DOCSIS section 4.2.10.1.1 states, "Spurious emissions from a transmitted carrier may occur in an adjacent channel that could be occupied by a carrier of the same or different symbol rates." TPC 13 shows the measured ACP for a +57 dBmV 16 QAM signal taken at the output of the AD8327 evaluation board, through a 75 Ω to 50 Ω matching pad (5.7 dB of loss). The transmit channel width and adjacent channel width in TPC 13 correspond to symbol rates of 160 $K_{SYM/S}$. Table III shows the ACP results for the AD8327 driving a 16 QAM, +57 dBmV signal for all conditions in DOCSIS Table 4-7 "Adjacent Channel Spurious Emissions."

Table III. Adjacent Channel Power

TRANSMIT SYMBOL RATE	ADJACENT CHANNEL SYMBOL RATE				
	160 $K_{SYM/SEC}$	320 $K_{SYM/SEC}$	640 $K_{SYM/SEC}$	1280 $K_{SYM/SEC}$	2560 $K_{SYM/SEC}$
160 $K_{SYM/SEC}$	ACP (dBc) -62	ACP (dBc) -63	ACP (dBc) -65	ACP (dBc) -66	ACP (dBc) -66
320 $K_{SYM/SEC}$	ACP (dBc) -62	ACP (dBc) -63	ACP (dBc) -64	ACP (dBc) -66	ACP (dBc) -66
640 $K_{SYM/SEC}$	ACP (dBc) -63	ACP (dBc) -62	ACP (dBc) -63	ACP (dBc) -65	ACP (dBc) -66
1280 $K_{SYM/SEC}$	ACP (dBc) -64	ACP (dBc) -63	ACP (dBc) -63	ACP (dBc) -63	ACP (dBc) -64
2560 $K_{SYM/SEC}$	ACP (dBc) -66	ACP (dBc) -63	ACP (dBc) -63	ACP (dBc) -62	ACP (dBc) -63

Noise and DOCSIS

At minimum gain, the AD8327 output noise spectral density is $11 \text{ nV}/\sqrt{\text{Hz}}$ measured at 10 MHz. DOCSIS Table 4-8, "Spurious Emissions in 5 MHz to 42 MHz," specifies the output noise for various symbol rates. The calculated noise in dBmV for $160_{\text{KSYM/SECOND}}$ is:

$$\left(20 \log \left(\sqrt{\left(\frac{11 \text{ nV}}{\sqrt{\text{Hz}}} \right)^2 \times 160 \text{ kHz}} \right) \right) + 60 = -47 \text{ dBmV}$$

Comparing the computed noise power of -47 dBmV to the $+8 \text{ dBmV}$ signal yields -55 dBc , which meets the required level set forth in DOCSIS Table 4-8. As the AD8327 gain is increased above this minimum value, the output signal increases at a faster rate than the noise, resulting in a signal to noise ratio that improves with gain. In transmit disable mode, the output noise spectral density is $1.3 \text{ nV}/\sqrt{\text{Hz}}$, which results in -66 dBmV when computed over 160 KSYM/S . The noise power was measured directly at the output of the AD8327AR-EVAL board.

Evaluation Board Features and Operation

The AD8327 evaluation board (Part #AD8327AR-EVAL) and control software can be used to control the AD8327 upstream cable driver via the parallel port of a PC. A standard printer cable connected between the parallel port of the personal computer is used to feed all the necessary data to the AD8327 using the Windows-based control software. This package provides a means of evaluating the amplifier with a convenient way to program the gain/attenuation, as well as offering easy control of the asynchronous TXEN and SLEEP pins. With this evaluation kit, the AD8327 can be evaluated in either a single-ended or differential input configuration. A schematic of the evaluation board is provided in Figure 10.

Overshoot on PC Printer Ports

The data lines on some PC parallel printer ports have excessive overshoot that may cause communications problems when presented to the CLK pin of the AD8327. The evaluation board was designed to accommodate a series resistor and shunt capacitor (R2 and C5 in Figure 10) to filter the CLK signal if required.

Installing Visual Basic Control Software

Install the "CabDrive_27" software by running "setup.exe" on disk one of the AD8327 Evaluation Software. Follow on-screen directions and insert disk two when prompted. Choose installation directory, and then select the icon in the upper left to complete installation.

Running AD8327 Software

To load the control software, go to START, PROGRAMS, CABDRIVE_27, or select the AD8327.exe from the installed directory. Once loaded, select the proper parallel port to communicate with the AD8327 (Figure 8).

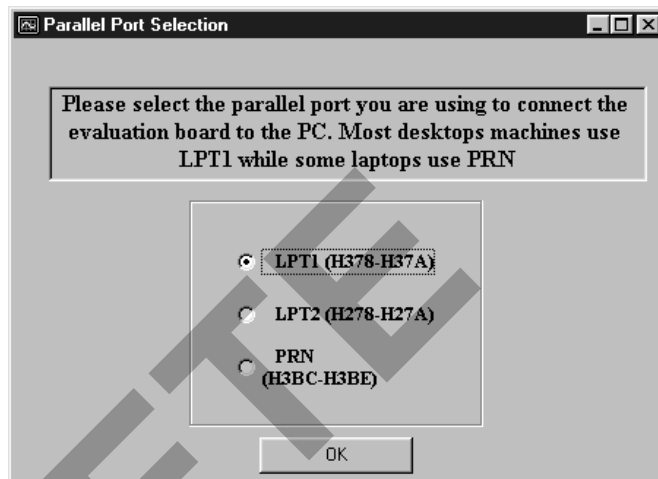

Figure 8. Parallel Port Selection

Controlling Gain/Attenuation of the AD8327

The slide bar controls the gain/attenuation of the AD8327, which is displayed in dB and in V/V. The gain scales 6 dB per major carry. The gain code from the position of the slide bar is displayed in decimal, binary, and hexadecimal (Figure 9).

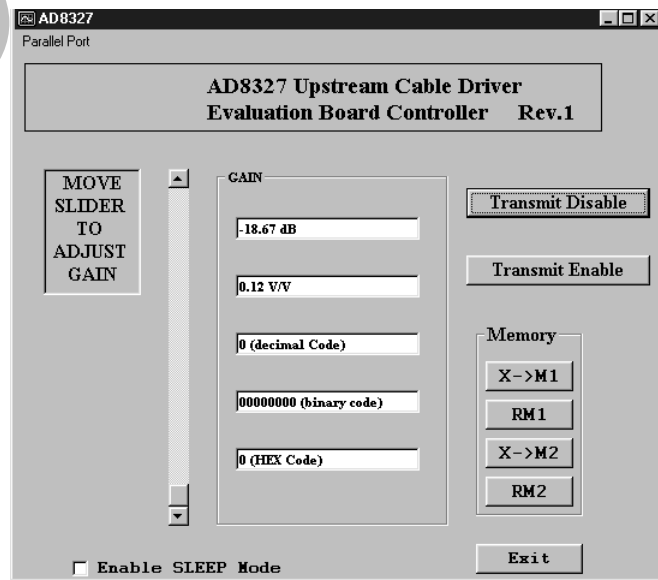

Figure 9. Control Software Interface

AD8327

Transmit Enable and Sleep Mode

The Transmit Enable and Transmit Disable buttons select the mode of operation of the AD8327 by asserting logic levels on the asynchronous TXEN pin. The Transmit Disable button applies Logic 0 to the TXEN pin, disabling forward transmission while maintaining a 75 Ω back termination. The Transmit Enable button applies Logic 1 to the TXEN pin, enabling the AD8327 for forward transmission. Checking the “Enable SLEEP Mode” checkbox applies logic “0” to the asynchronous SLEEP pin, setting the AD8327 for SLEEP mode.

Memory Functions

The MEMORY section of the software provides a way to alternate between two gain settings. The “X->M1” button stores the current value of the gain slide bar into memory while the “RM1” button recalls the stored value, returning the gain slide bar to the stored level. The same applies to the “X->M2” and “RM2” buttons.

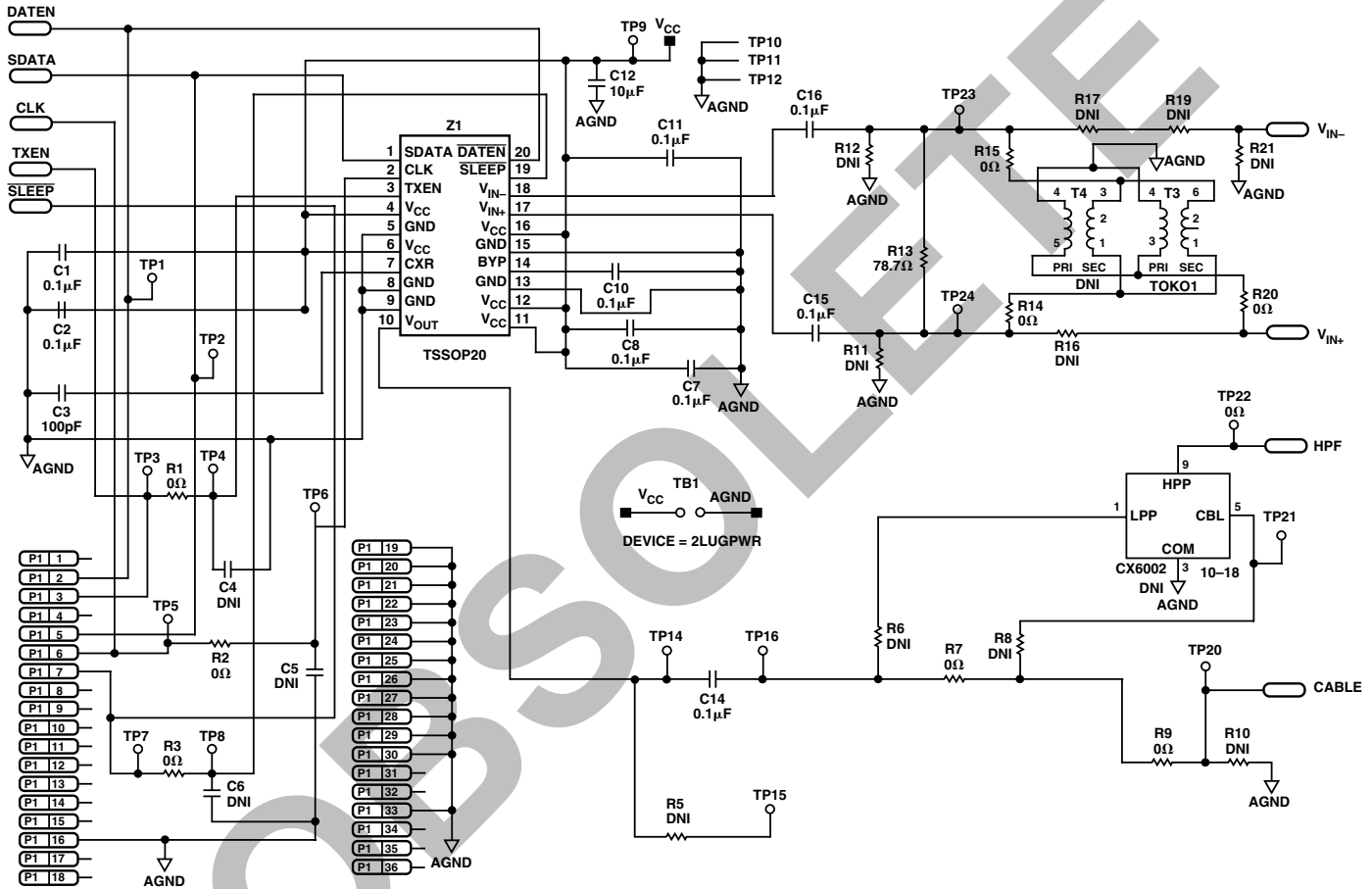

Figure 10. Evaluation Board Schematic

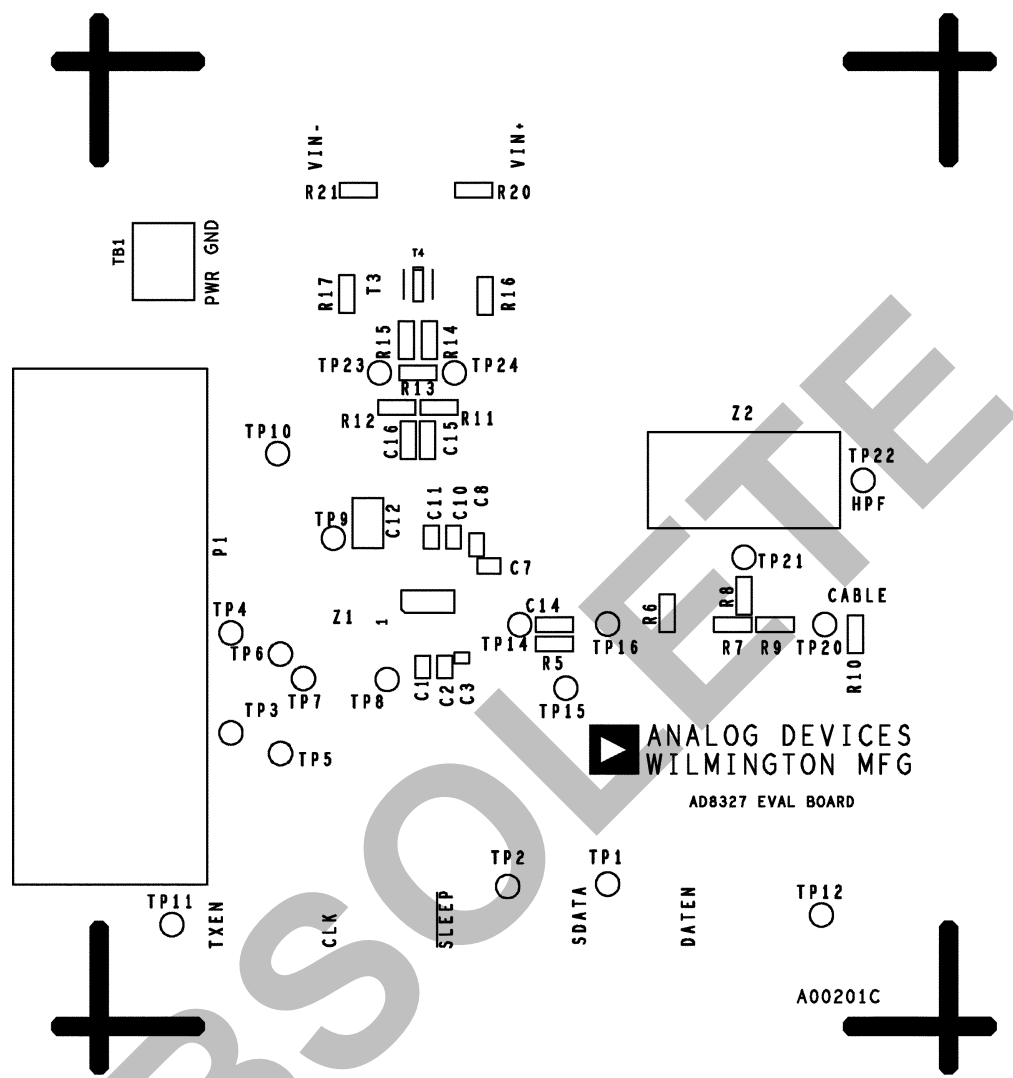

Figure 11. Evaluation Board Layout—Top Silkscreen

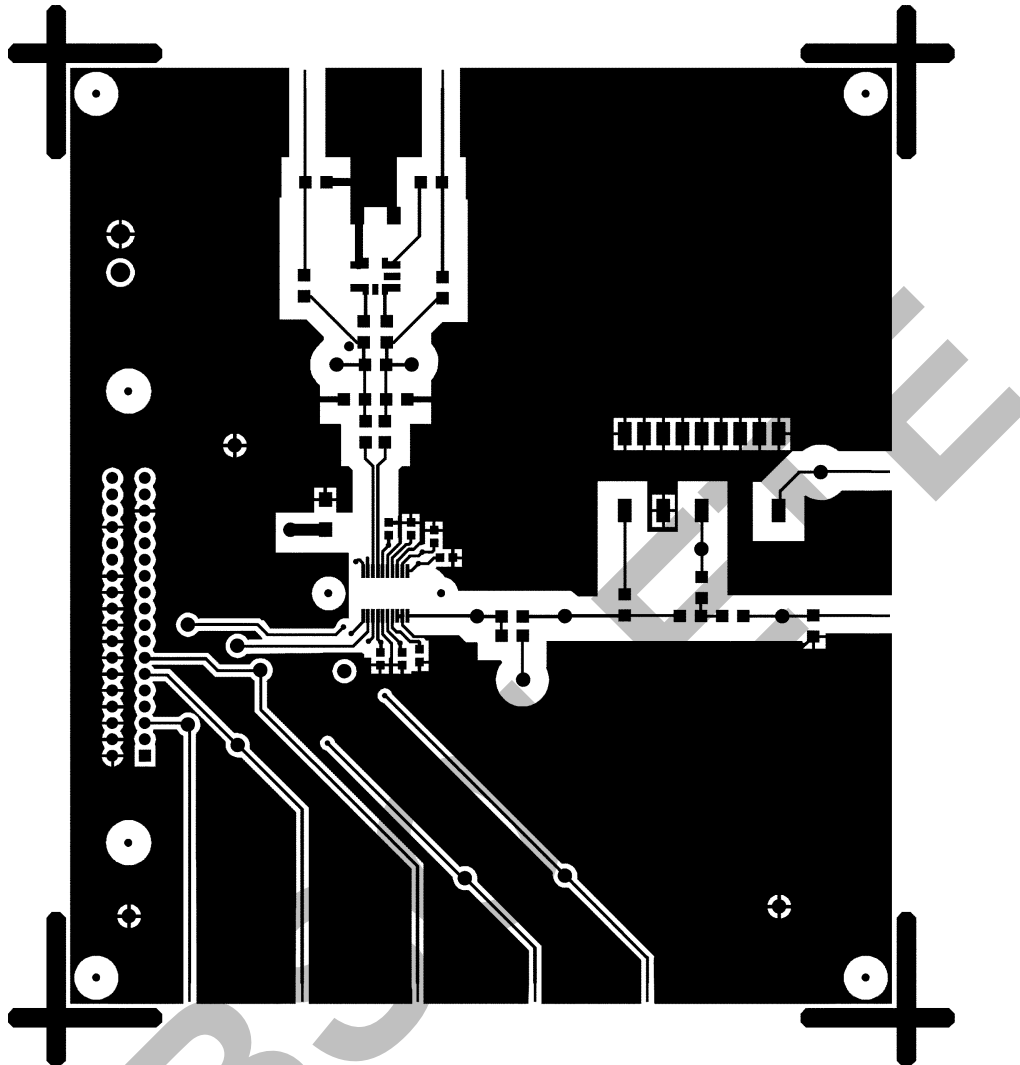

Figure 12. Evaluation Board Layout—Component Side

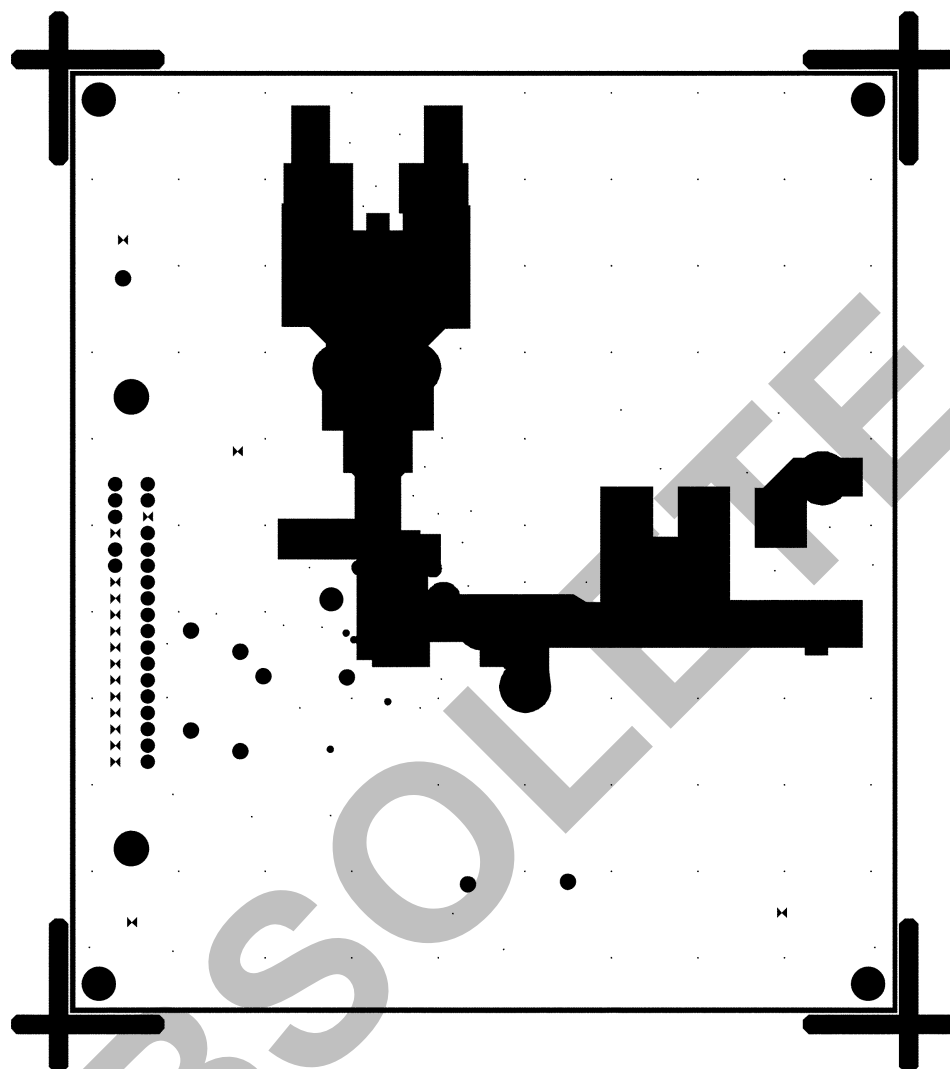

Figure 13. Evaluation Board Layout—Internal Ground Plane

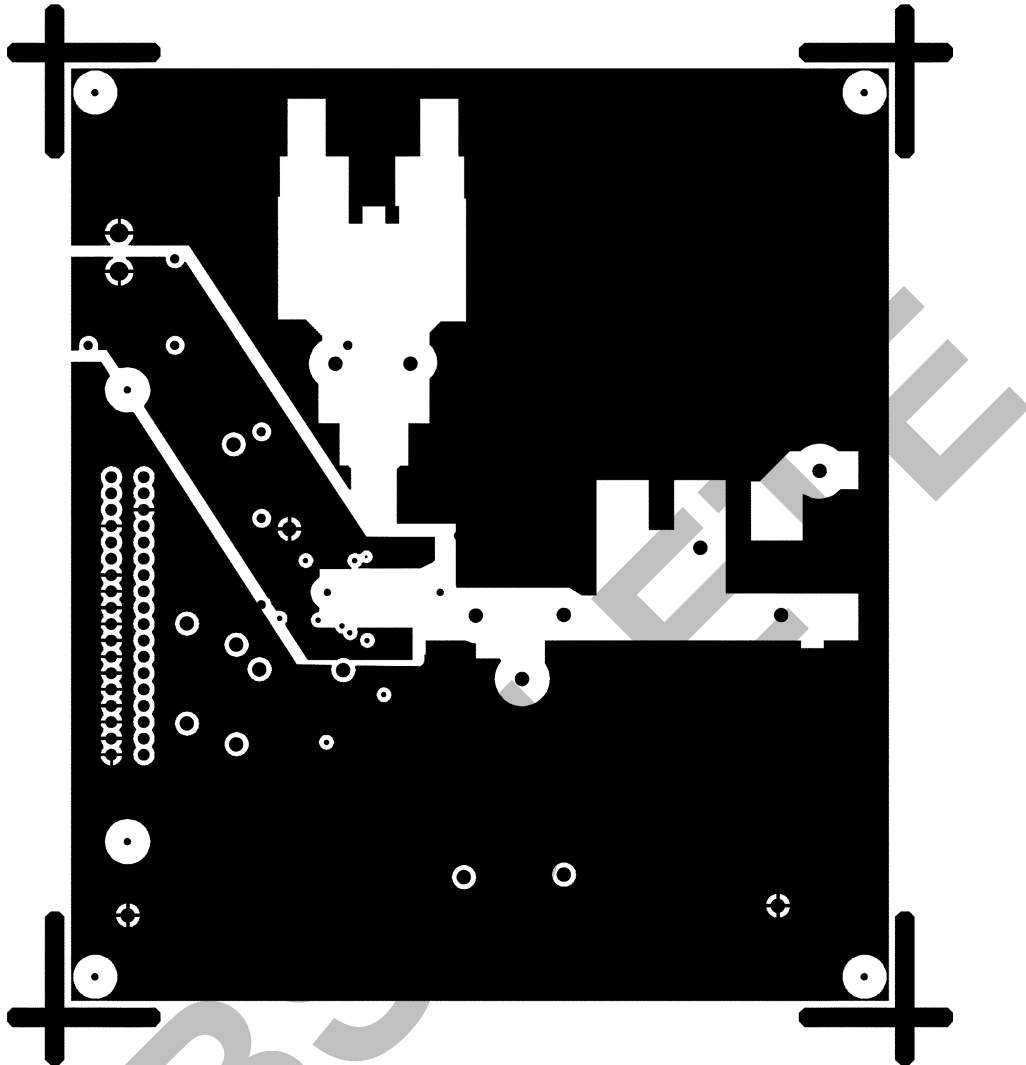

Figure 14. Evaluation Board Layout—Internal Power and Ground Plane

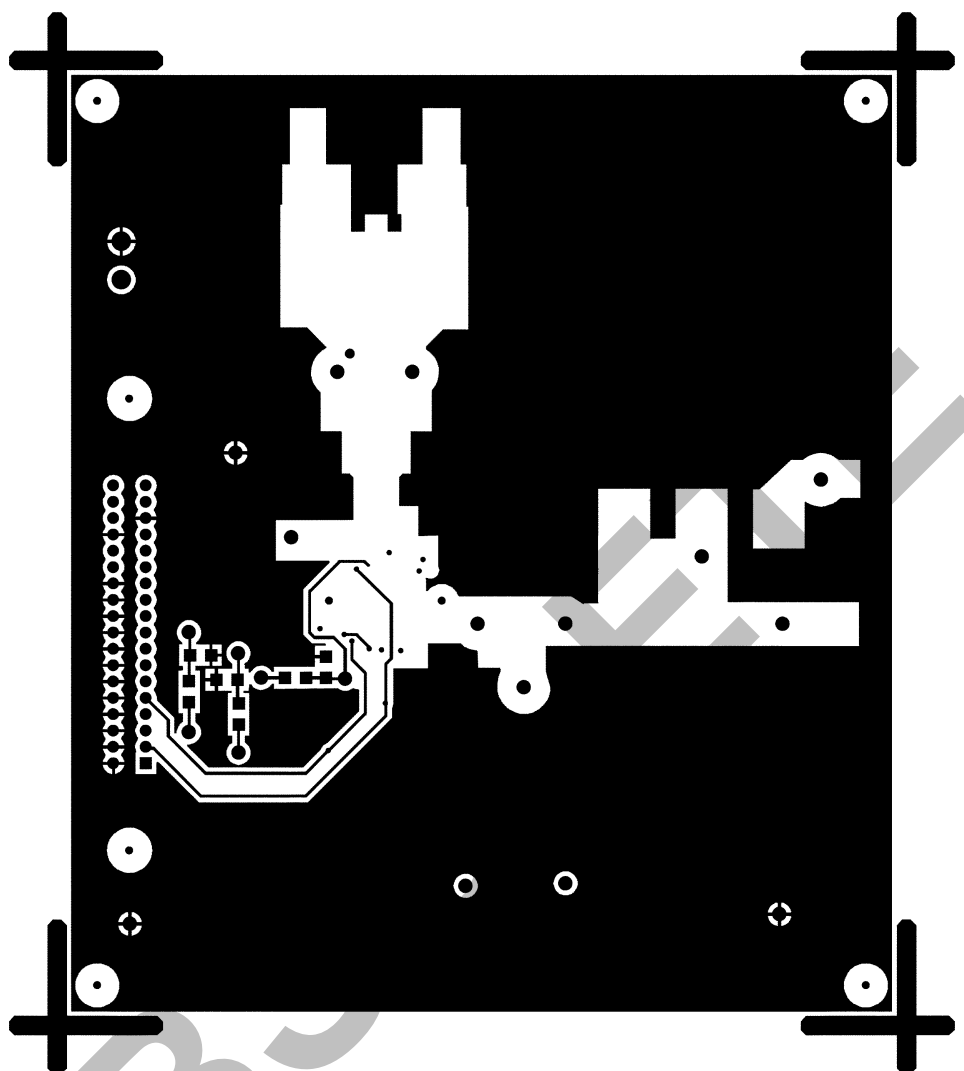

Figure 15. Evaluation Board Layout—Circuit Side

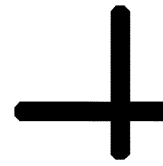
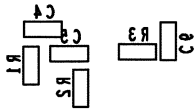
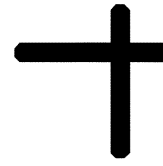
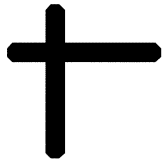

Figure 16. Evaluation Board Layout—Bottom Silkscreen

OBSOLETE

EVALUATION BOARD BILL OF MATERIALS

AD8327 Evaluation Board Rev. B, Single-Ended-to-Differential Input—Revised—February 21, 2001

Qty.	Description	Ref Description
1	10 μ F 25 V. 'D' size tantalum chip capacitor	C12
1	100 pF 0603 ceramic chip capacitor	C3
2	0.1 μ F 50 V. 1206 size ceramic chip capacitor	C15, C16
7	0.1 μ F 25 V. 0603 size ceramic chip capacitor	C1, C2, C7–C11
11	0 Ω 5% 1/8 W. 1206 size chip resistor	R1–R3, R7, R9, R14, R15, R20
1	78.7 Ω 1% 1/8 W. 1206 size chip resistor	R13
2	Yellow Test Point	TP23, TP24
1	Red Test Point	TP9
1	Black Test Point	TP10–TP12 (GND)
1	Centronics-type 36-pin Right-Angle Connector	P1
1	Terminal Block 2-Pos Green ED1973-ND	TB1
4	SMA End launch Jack (E F JOHNSON # 142-0701-801)	V _{IN-} , V _{IN+} , CABLE_0, HPF
1	1:1 Transformer TOKO # 617DB – A0070	T3
1	PULSE Diplexer*	Z2
1	AD8327 (TSSOP) UPSTREAM Cable Driver	Z1
1	AD8327 REV. C Evaluation PC board	Evaluation PC board
4	#4–40 \times 1/4 inch STAINLESS panhead machine screw	(P1 Hardware)
4	#4–40 \times 3/4 inch long aluminum round stand-off	(P1 Hardware)
2	# 2–56 \times 3/8 inch STAINLESS panhead machine screw	(P1 Hardware)
2	# 2 steel flat washer	(P1 Hardware)
2	# 2 steel internal tooth lockwasher	(P1 Hardware)
2	# 2 STAINLESS STEEL hex. machine nut	(P1 Hardware)

NOTES

*PULSE Diplexer part numbers B5008 (42 MHz), CX6002 (42 MHz), B5009 (65 MHz).

DO NOT INSTALL C4, C5, C6, R6, R7, R8, R10–R12, R16, R17, R21, T9, TP1–TP8, TP14–TP16, TP20–TP22.

SMA's TXEN, CLK, SLEEP, DATEN, SDATA, HPF_0, Z2.

OUTLINE DIMENSIONS
 Dimensions shown in inches and (mm).

**20-Lead TSSOP
 (RU-20)**

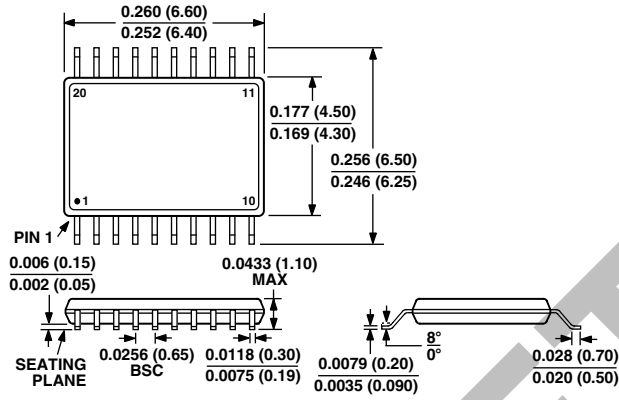

OBSOLETE