

FEATURES

- Low noise figure: 1.8 dB**
- P1dB output power: 14.5 dBm**
- P_{SAT} output power: 17.5 dBm**
- High gain: 15 dB**
- Output IP3: 29 dBm**
- Supply voltage: V_{DD} = 7 V at 70 mA**
- 50 Ω matched input/output (I/O)**
- 32-lead, 5 mm × 5 mm LFCSP package: 25 mm²**

APPLICATIONS

- Test instrumentation**
- High linearity microwave radios**
- VSAT and SATCOM**
- Military and space**

GENERAL DESCRIPTION

The HMC1049LP5E is a GaAs MMIC low noise amplifier (LNA) that operates between 0.3 GHz and 20 GHz. This LNA provides 15 dB of small signal gain, 1.8 dB noise figure, and an IP3 output of 29 dBm, yet requires only 70 mA from a 7 V supply. The P1dB output power of 14.5 dBm enables the LNA to function as a local oscillator (LO) driver for balanced, I/Q, or

FUNCTIONAL BLOCK DIAGRAM

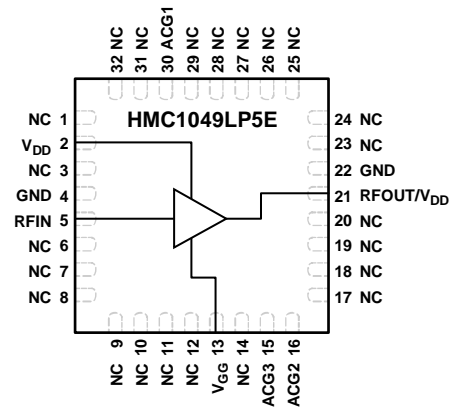

Figure 1.

image rejection mixers. V_{DD} can also be applied to Pin 21, although Pin 21 requires a bias tee with V_{DD} = 4 V. The HMC1049LP5E amplifier I/Os are internally matched to 50 Ω, and the device is supplied in a compact, leadless 5 mm × 5 mm LFCSP package.

Rev. B

[Document Feedback](#)

Information furnished by Analog Devices is believed to be accurate and reliable. However, no responsibility is assumed by Analog Devices for its use, nor for any infringements of patents or other rights of third parties that may result from its use. Specifications subject to change without notice. No license is granted by implication or otherwise under any patent or patent rights of Analog Devices. Trademarks and registered trademarks are the property of their respective owners.

One Technology Way, P.O. Box 9106, Norwood, MA 02062-9106, U.S.A.
 Tel: 781.329.4700 ©2018 Analog Devices, Inc. All rights reserved.
[Technical Support](#) www.analog.com

TABLE OF CONTENTS

Features	1	Pin Configuration and Function Descriptions.....	5
Applications.....	1	Interface Schematics	6
Functional Block Diagram	1	Typical Performance Characteristics	7
General Description	1	Evaluation Printed Circuit Board.....	12
Revision History	2	Packaging and Ordering Information	14
Specifications.....	3	Outline Dimensions	14
Absolute Maximum Ratings	4	Ordering Guide	14
ESD Caution.....	4		

REVISION HISTORY

5/2018—Rev. A to Rev. B

Changed HMC1049 to HMC1049LP5E.....	Throughout
Changes to Features Section and General Description Section .	1
Change to Figure 27 Caption and Figure 28 Caption	10
Updated Outline Dimensions	14
Changes to Ordering Guide	14

11/2014—Rev. 01.1213 to Rev. A

This Hittite Microwave Products data sheet has been reformatted to meet the styles and standards of Analog Devices, Inc.

Updated Format.....	Universal
Changes to General Description	1
Change to Table 2, Thermal Resistance Parameter Column	4
Added Figure 2.....	5
Changes to Table 4.....	5
Moved Figure 3 to Figure 9 to Interface Schematics Section	6
Change to Figure 8 and Figure 9	6
Changes to Figure 36.....	13
Added Ordering Guide Section.....	15

SPECIFICATIONS

$T_A = 25^\circ\text{C}$, $V_{DD} = 7\text{ V}$, $I_{DD} = 70\text{ mA}$ ¹.

Table 1.

Parameter	Min	Typ	Max	Min	Typ	Max	Min	Typ	Max	Unit
FREQUENCY RANGE	0.3		1	1		14	14		20	GHz
GAIN	13.5	16.5		12	15		10	13		dB
Gain Variation Over Temperature		0.006			0.019			0.017		dB/°C
NOISE FIGURE		2.5	3.5		1.8	2.5		2.7	4.0	dB
RETURN LOSS										
Input		15			13			14		dB
Output		8			15			13		dB
OUTPUT										
Output Power for 1 dB Compression (P1dB)		15			14.5			13		dBm
Saturated (P_{SAT})		18			17.5			16		dBm
Output Third-Order Intercept (IP3) ²		31			29			26		dBm
TOTAL SUPPLY CURRENT		70			70			70		mA

¹ Adjust V_{GG} between -2 V to 0 V to achieve $I_{DD} = 70\text{ mA}$ typical.

² Measurement taken at $P_{OUT}/\text{tone} = 8\text{ dBm}$.

ABSOLUTE MAXIMUM RATINGS

Table 2.

Parameter	Rating
Drain Bias Voltage (V_{DD})	10 V
Drain Bias Voltage (RF Out/ V_{DD})	7 V
RF Input Power	18 dBm
Gate Bias Voltage, V_{GG}	-2 V to +0.2 V
Channel Temperature	175°C
Continuous P_{DISS} ($T = 85^{\circ}\text{C}$) (Derate 37.1 mW/ $^{\circ}\text{C}$ Above 85°C)	3.34 W
Thermal Resistance (Channel to Ground Paddle)	26.9°C/W
Temperature	
Storage Temperature	-65°C to +150°C
Operating Temperature	-40°C to +85°C
ESD Sensitivity (HBM)	Class 1A

Stresses at or above those listed under Absolute Maximum Ratings may cause permanent damage to the product. This is a stress rating only; functional operation of the product at these or any other conditions above those indicated in the operational section of this specification is not implied. Operation beyond the maximum operating conditions for extended periods may affect product reliability.

Table 3. Typical Supply Current vs. V_{DD}

V_{DD} (V)	I_{DD}^1 (mA)
5	70
6	70
7	70

¹ Adjust V_{GG} to achieve $I_{DD} = 70$ mA.

ESD CAUTION

ESD (electrostatic discharge) sensitive device. Charged devices and circuit boards can discharge without detection. Although this product features patented or proprietary protection circuitry, damage may occur on devices subjected to high energy ESD. Therefore, proper ESD precautions should be taken to avoid performance degradation or loss of functionality.

PIN CONFIGURATION AND FUNCTION DESCRIPTIONS

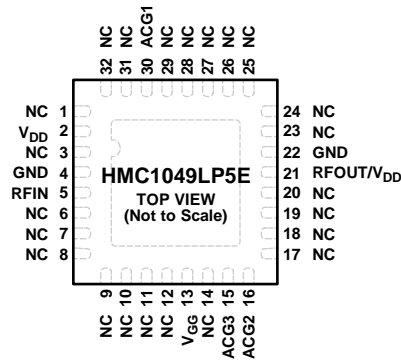

NOTES

1. NC = NO CONNECT. THESE PINS ARE NOT CONNECTED INTERNALLY; HOWEVER, ALL DATA WAS MEASURED WITH THESE PINS CONNECTED TO RF/DC GROUND EXTERNALLY.
2. EXPOSED PAD. THE EXPOSED GROUND PADDLE MUST BE CONNECTED TO RF/DC GROUND.

16798-004

Figure 2. Pin Configuration Diagram

Table 4. Pin Function Descriptions

Pin No.	Mnemonic	Description ¹
1, 3, 6 to 12, 14, 17 to 20, 23 to 29, 31, 32	NC	No Connect. These pins are not connected internally; however, all data was measured with these pins connected to RF/dc ground externally (see the Typical Performance Characteristics section for data plots).
5	RFIN	RF Input. This pin is dc-coupled and matched to 50 Ω.
2	V _{DD}	Power Supply Voltage for the Amplifier. External bypass capacitors (100 pF and 0.01 μF) are required.
30	ACG1	Low Frequency Termination. An external bypass capacitor of 100 pF is required.
21	RFOUT/V _{DD}	RF Output/Alternate Power Supply Voltage for the Amplifier. An external bias tee is required when used as alternative V _{DD} . This pin is dc-coupled and matched to 50 Ω.
15, 16	ACG2, ACG3	Low Frequency Termination. External bypass capacitors of 100 pF are required.
13	V _{GG}	Gate Control for Amplifier. Adjust the voltage to achieve I _{DD} = 70 mA. External bypass capacitors of 100 pF, 0.01 μF, and 4.7 μF are required.
4, 22	GND	Ground. Connect Pin 4 and Pin 22 to RF/dc ground.
0	EP	Exposed Pad. The exposed ground paddle must be connected to RF/dc ground.

¹ See the Interface Schematics section for pin interfaces.

INTERFACE SCHEMATICS

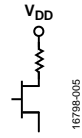

Figure 3. V_{DD} Interface



Figure 4. GND Interface

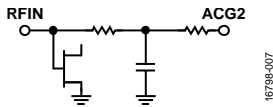

Figure 5. $RFIN$ Interface

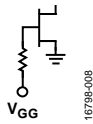

Figure 6. V_{GG} Interface

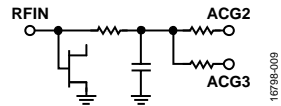

Figure 7. $ACG2$ and $ACG3$ Interface

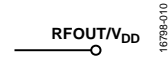

Figure 8. $RFOUT/V_{DD}$ Interface

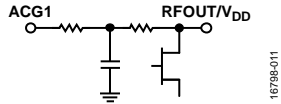

Figure 9. $ACG1$ Interface

TYPICAL PERFORMANCE CHARACTERISTICS

Data taken with V_{DD} applied to Pin 2, $V_{DD} = 7$ V.

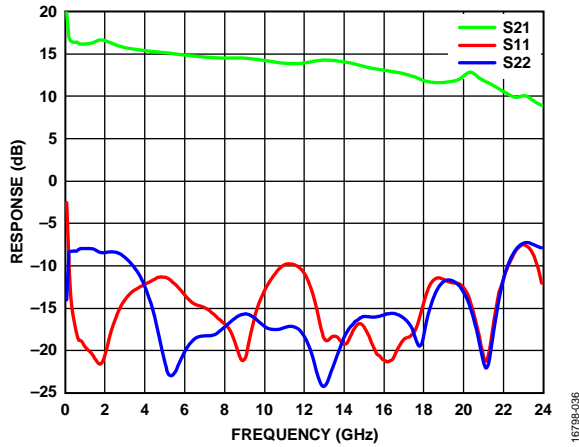

Figure 10. Broadband Gain and Return Loss

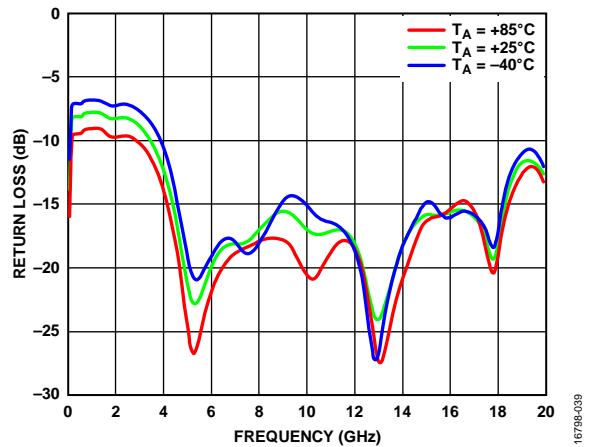

Figure 13. Output Return Loss vs. Temperature

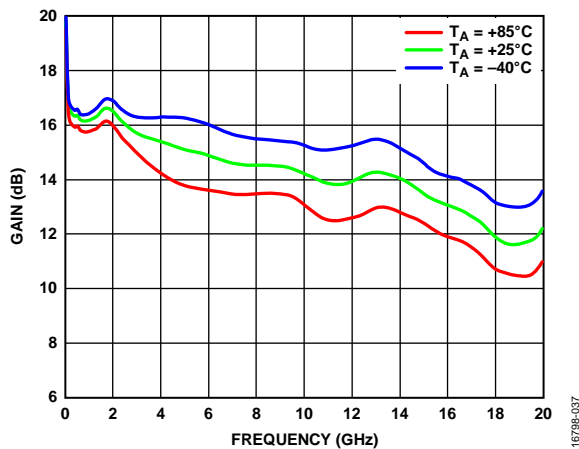

Figure 11. Gain vs. Temperature

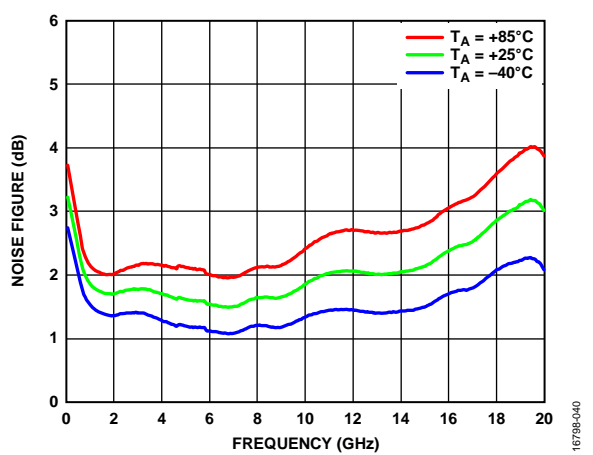

Figure 14. Noise Figure vs. Temperature

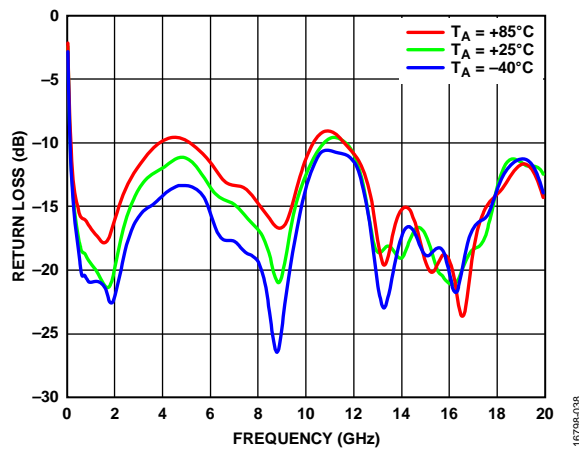

Figure 12. Input Return Loss vs. Temperature

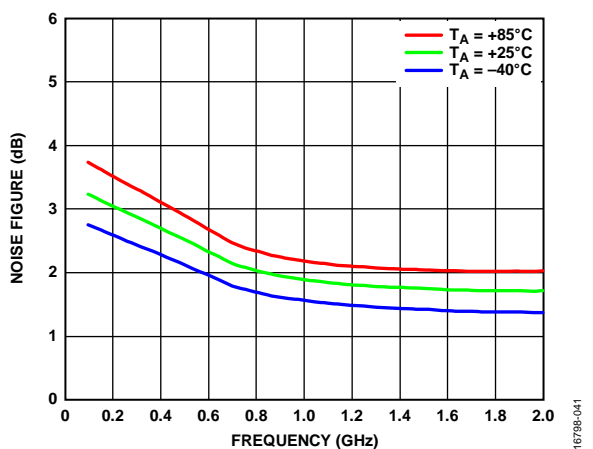

Figure 15. Noise Figure vs. Temperature, Low Frequency

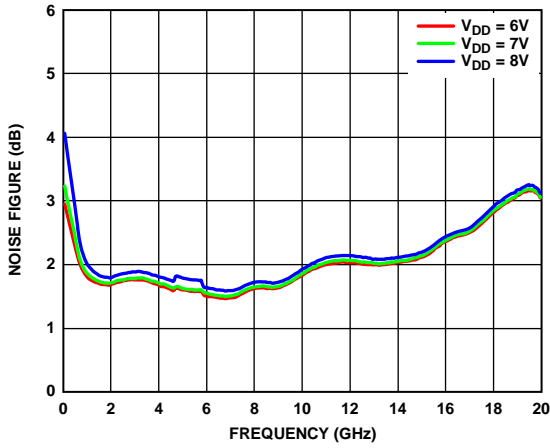

Figure 16. Noise Figure vs. V_{DD}

16798-042

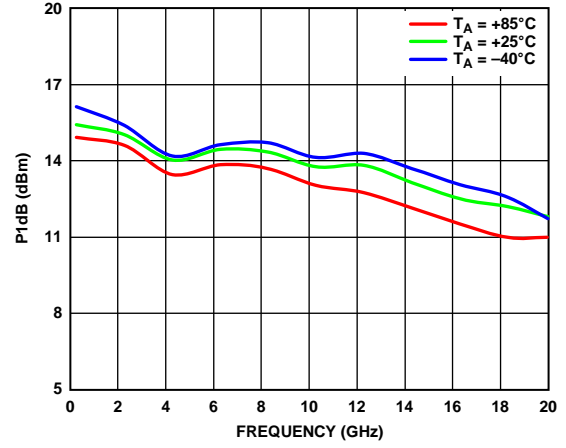

Figure 19. P1dB vs. Temperature

16798-045

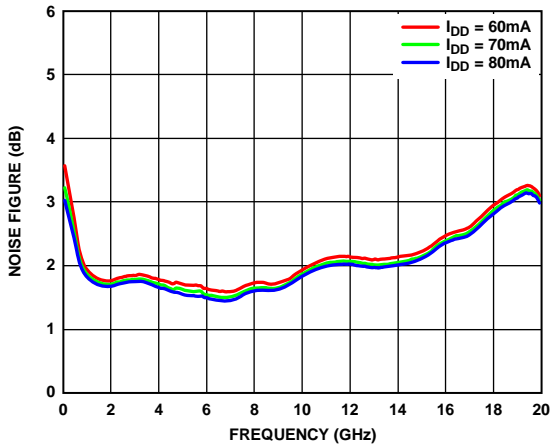

Figure 17. Noise Figure vs. I_{DD}

16798-043

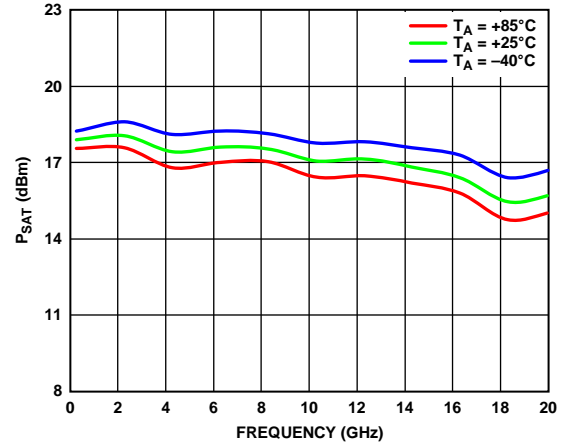

Figure 20. P_{SAT} vs. Temperature

16798-046

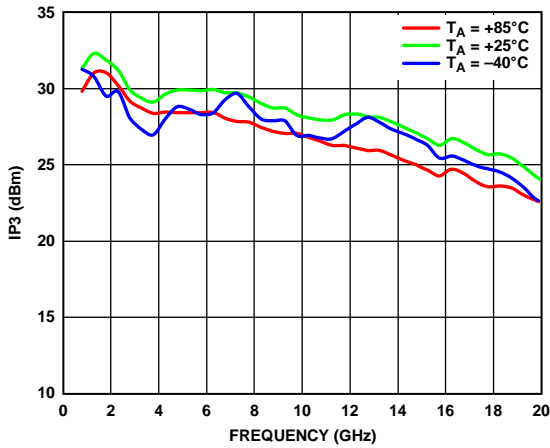

Figure 18. Output $IP3$ vs. Temperature

16798-044

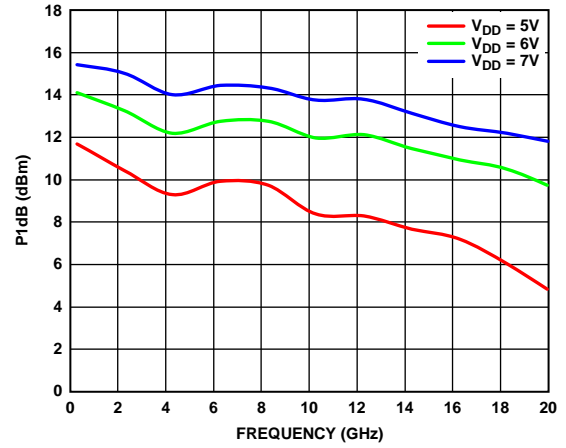

Figure 21. P1dB vs. V_{DD}

16798-047

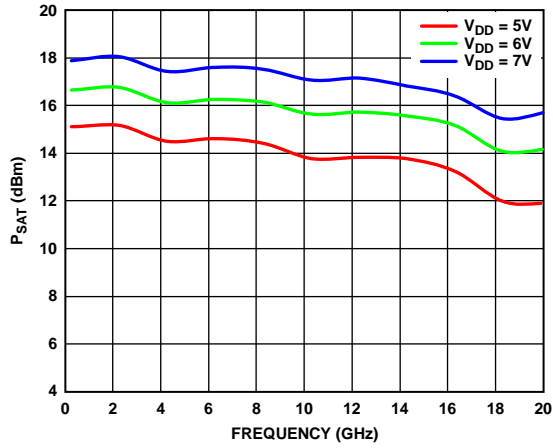

Figure 22. P_{SAT} vs. V_{DD}

167798-048

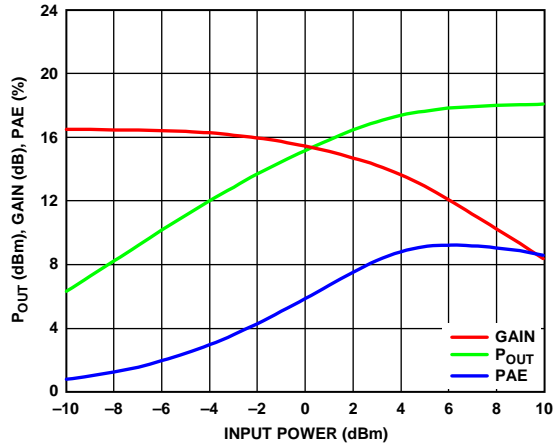

Figure 24. Power Compression at 2 GHz

167798-050

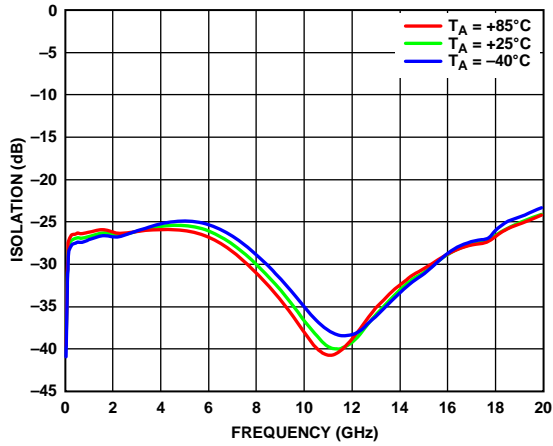

Figure 23. Reverse Isolation vs. Temperature

167798-049

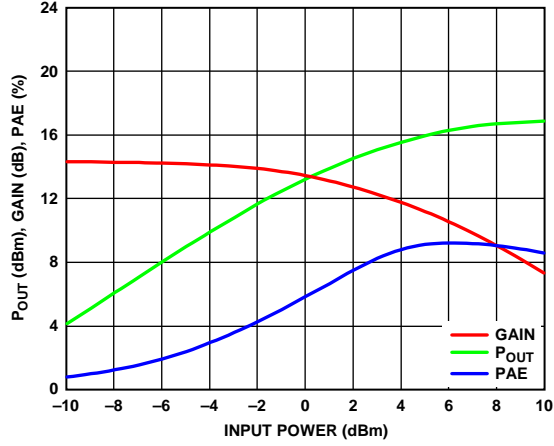

Figure 25. Power Compression at 10 GHz

167798-051

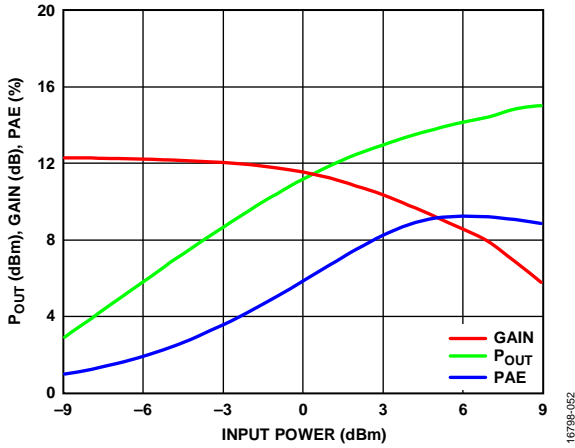

Figure 26. Power Compression at 18 GHz

16798-052

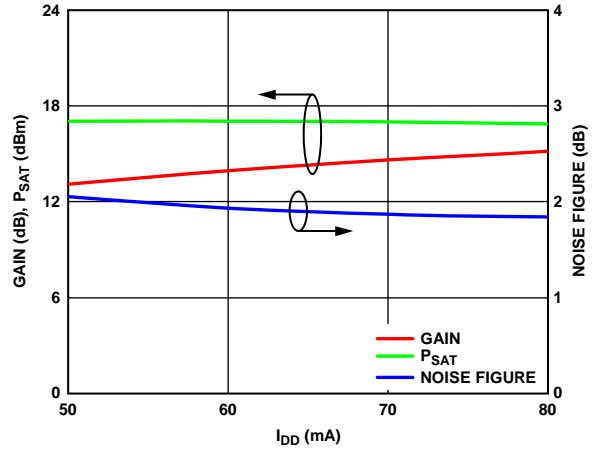

Figure 28. Gain, P_{SAT}, and Noise Figure vs. I_{DD} at 12 GHz

16798-054

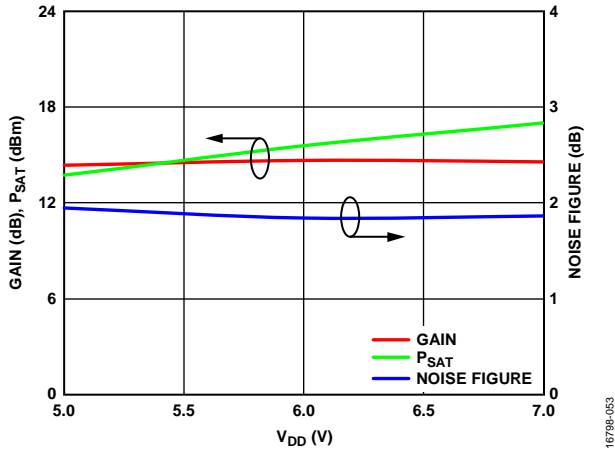

Figure 27. Gain, P_{SAT}, and Noise Figure vs. V_{DD} at 12 GHz

16798-053

Data taken with V_{DD} applied to the bias tee at Pin 21.

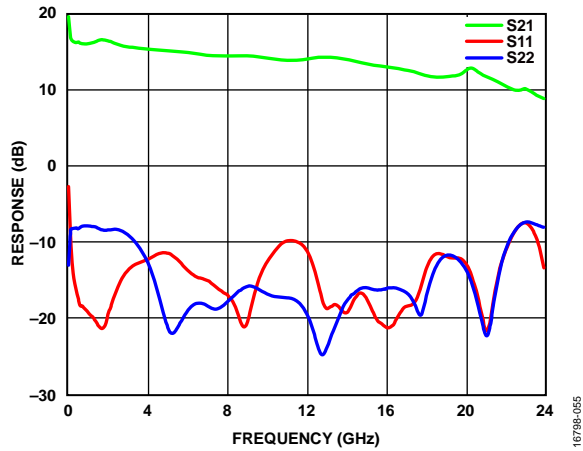

Figure 29. Broadband Gain and Return Loss, $V_{DD} = 4 V$, Supply to Bias Tee

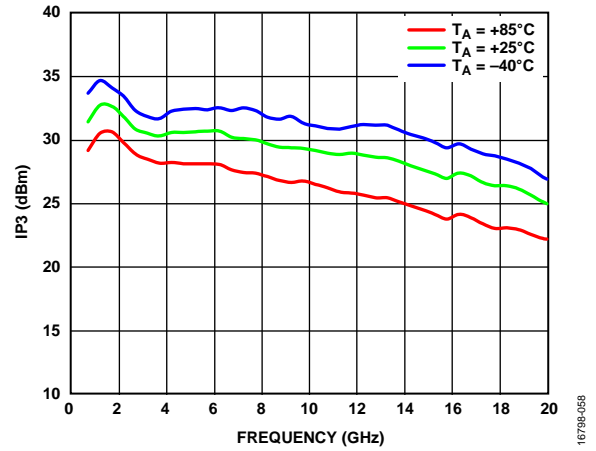

Figure 32. Output IP3 vs. Temperature, $V_{DD} = 4 V$, Supply to Bias Tee

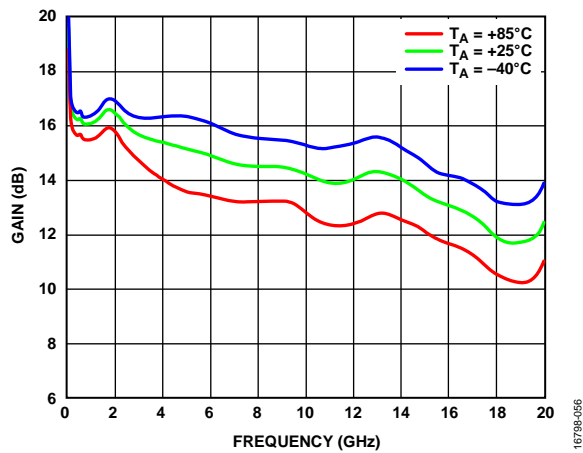

Figure 30. Gain vs. Temperature, $V_{DD} = 4 V$, Supply to Bias Tee

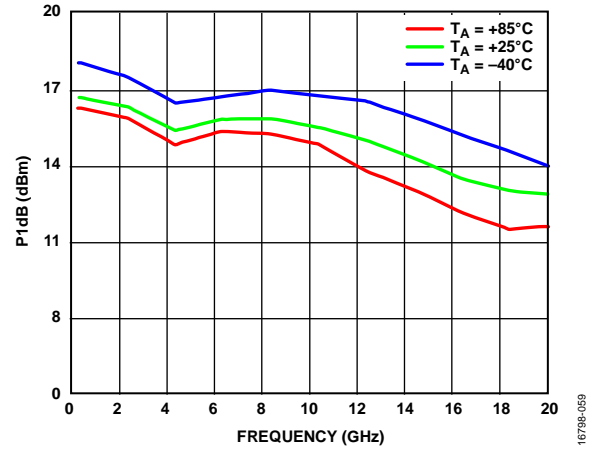

Figure 33. P1dB vs. Temperature, $V_{DD} = 4 V$, Supply to Bias Tee

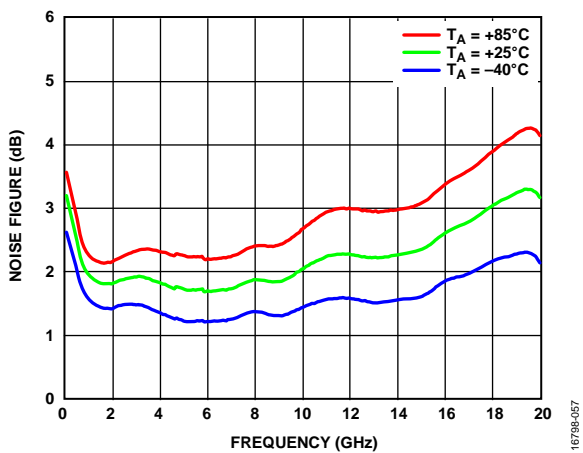

Figure 31. Noise Figure vs. Temperature, $V_{DD} = 4 V$, Supply to Bias Tee

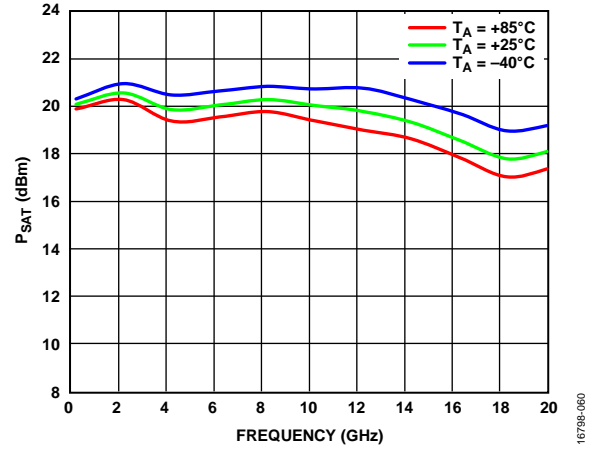

Figure 34. P_{SAT} vs. Temperature, $V_{DD} = 4 V$, Supply to Bias Tee

EVALUATION PRINTED CIRCUIT BOARD

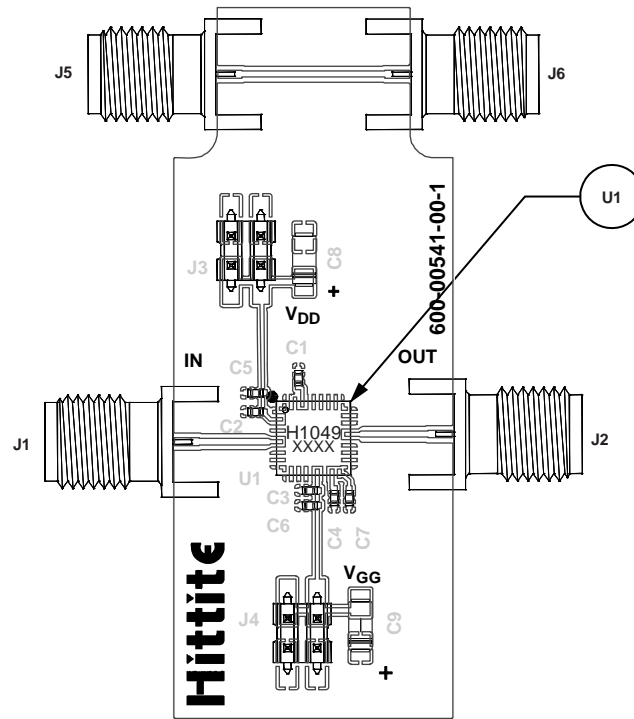

Figure 35. Evaluation Board Layout

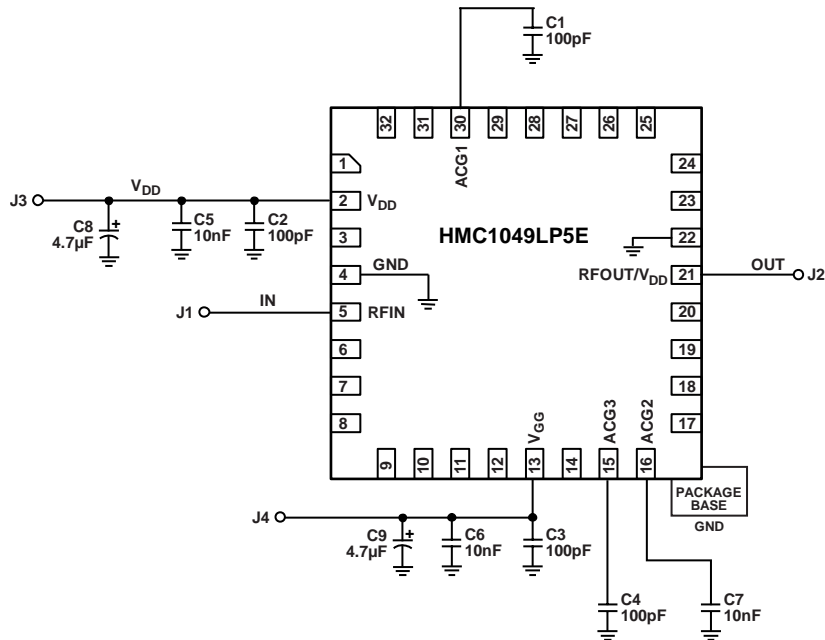

Figure 36. Evaluation Board Schematic

Table 5. List of Materials for Evaluation PCB

Item	Description
J1, J2, J5, J6	PCB mount SMA RF connector
J3, J4	DC pins
C1 to C4	100 pF capacitor, 0402 package
C5 to C7	10000 pF capacitor, 0402 package
C8, C9	4.7 μ F capacitor, tantalum
U1	HMC1049LP5E
PCB ¹	600-00541-00-1 evaluation PCB

¹ Circuit board material: Rogers 4350 or Arlon 25FR.

The circuit board used in the application should use RF circuit design techniques. Signal lines should have 50 Ω impedance; connect the package ground leads and exposed paddle directly to the ground plane. Use a sufficient number of via holes to connect the top and bottom ground planes. The evaluation circuit board shown is available from Analog Devices, Inc., upon request.

PACKAGING AND ORDERING INFORMATION

OUTLINE DIMENSIONS

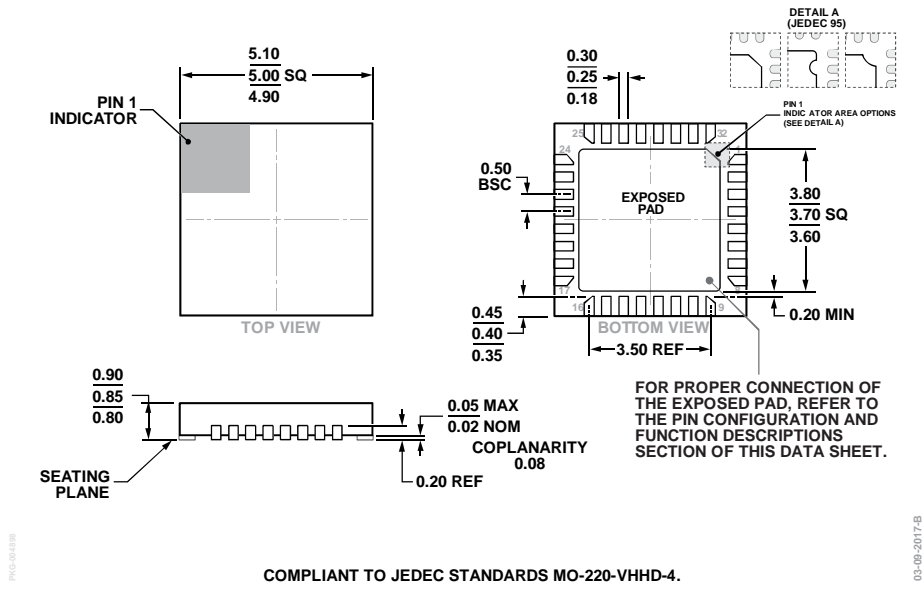

COMPLIANT TO JEDEC STANDARDS MO-220-VHHD-4.

Figure 37. 32-Lead Lead Frame Chip Scale Package [LFCSP]
 5 mm × 5 mm and 0.85 mm Package Height
 (HCP-32-1)
 Dimensions shown in millimeters

ORDERING GUIDE

Model ¹	Temperature Range	Lead Finish	Moisture Sensitivity Level (MSL) Rating ²	Package Description	Ordering Quantity	Package Option
HMC1049LP5E	-40°C to +85°C	100% matte Sn	MSL1	32-Lead LFCSP	500	HCP-32-1
HMC1049LP5ETR	-40°C to +85°C	100% matte Sn	MSL1	32-Lead LFCSP, 7" Tape and Reel		HCP-32-1
EVAL01-HMC1049LP5				Evaluation Board		

¹ All models are RoHS Compliant Parts.

² MSL1 rating indicates a maximum peak reflow temperature of 260°C.