

### Ceramic Resonators, Chip Type (3 Array Type)

- Type: **EFOS**
- Type: **EFOB**
- Type: **EFOSS**
- Type: **EFOSM**
- Type: **EFOBM**
- Type: **EFOJM**
- Type: **EFOST**



#### ■ Features

- Encased in a ceramic package
- High reliability against soldering heat and mechanical stress
- Moisture-proof sealing
- 1.2 mm maximum (SS/SM/BM/JM), 0.8 mm maximum (ST) in thickness
- Designed for reflow soldering
- Flat-bottom plate for better mountings
- Simplifies oscillation circuits by reducing the number of circuit parts
- RoHS compliant

#### ■ Recommended Applications

- Clock generator for microprocessors
- Carrier circuit between telecommunication equipment (Telephone to telephone, personal computer to printer)

#### ■ Handling Precautions (See Page 175 to 176)

#### ■ Packaging Specifications

See Page 169 to 177

#### ■ Explanation of Part Numbers

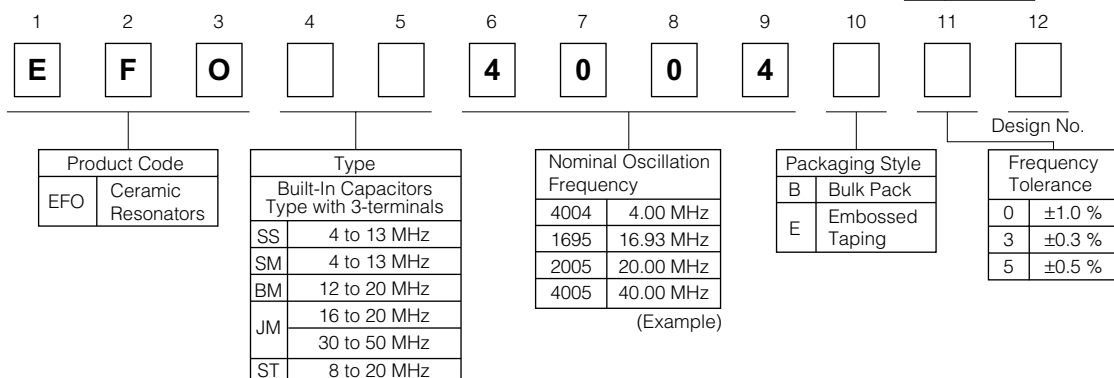
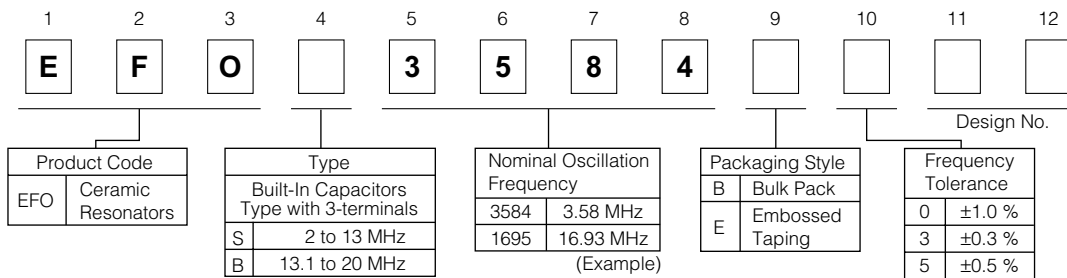

Part Number	Frequency range (MHz)	Frequency Temperature Characteristics (-20 to +80 °C)	Built-in Capacitors (Reference)
EFOS	2.00 to 8.39	±0.2 %	33 pF
	8.40 to 13.0	±1.0 %	
EFOB	13.1 to 20.0	±0.5 %	33 pF
EFOSS	4.00 to 8.39	±0.2 %	21 pF
	8.40 to 13.0	±0.3 %	
EFOSM	4.00 to 8.39	±0.2 %	33 pF
	8.40 to 13.0	±1.0 %	
EFOBM	12.0 to 20.0	±0.3 %	18 pF
EFOJM	16.0 to 20.0	±0.5 %	10 pF
	30.0 to 50.0	±0.2 %	
EFOST	8.00 to 12.9	±0.2 %	15 pF
	13.0 to 20.0	±0.5 %	

Design and specifications are each subject to change without notice. Ask factory for the current technical specifications before purchase and/or use. Should a safety concern arise regarding this product, please be sure to contact us immediately.

■ Dimensions in mm (not to scale)  
 Recommended Land Dimensions  
 [Type EFOS].....2.0 to 13.0 MHz

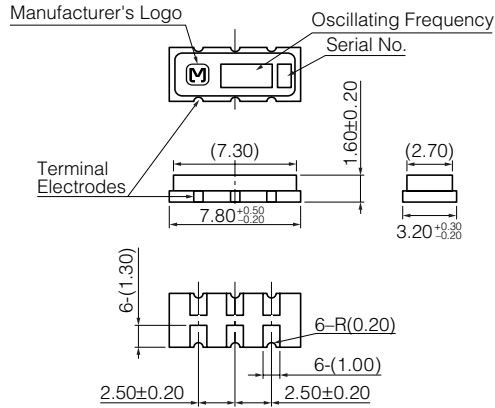

[Type EFOS, EFOSM]

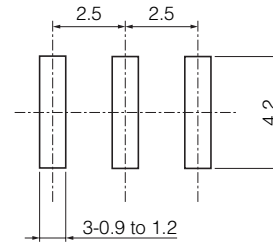

[Type EFOSM].....4.0 to 13.0 MHz

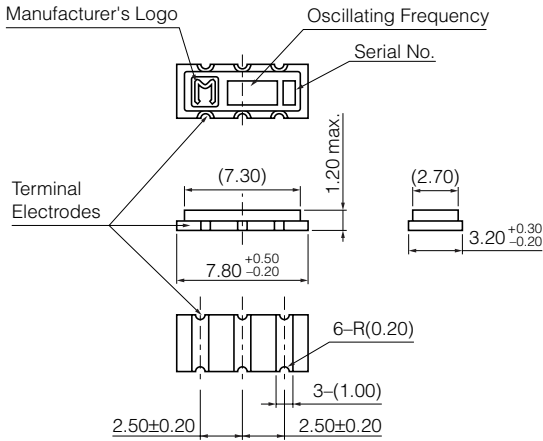

[Type EFOSS].....4.0 to 13.0 MHz

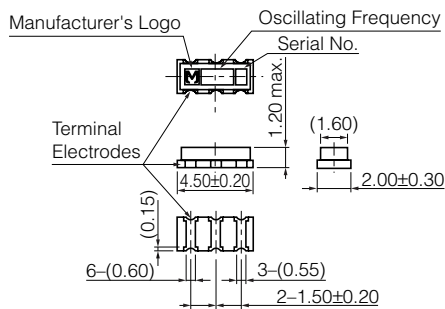

[Type EFOSS]

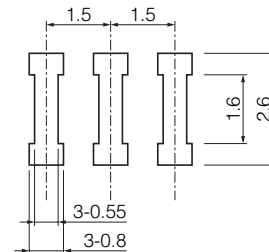

[Type EFOB].....13.1 to 20.0 MHz

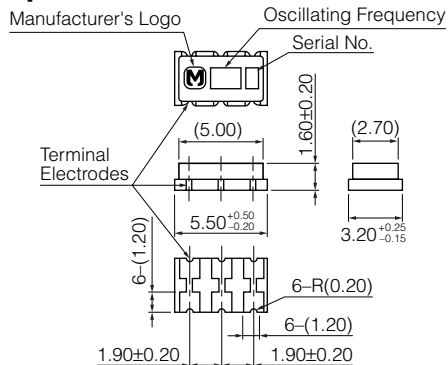

[Type EFOB]

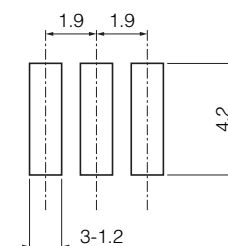

Design and specifications are each subject to change without notice. Ask factory for the current technical specifications before purchase and/or use. Should a safety concern arise regarding this product, please be sure to contact us immediately.

00 Apr. 2008

■ Dimensions in mm (not to scale)  
 Recommended Land Dimensions  
 [Type EFOBM].....12.0 to 20.0 MHz

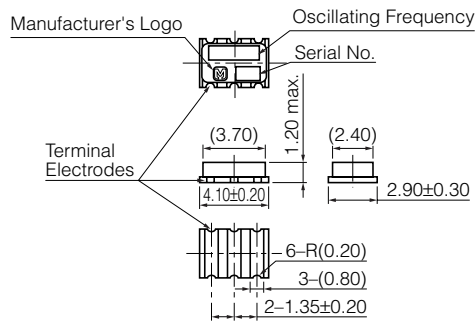

[Type EFOBM]

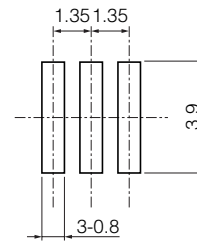

[Type EFOJM].....16.0 to 20.0, 30.0 to 50.0 MHz

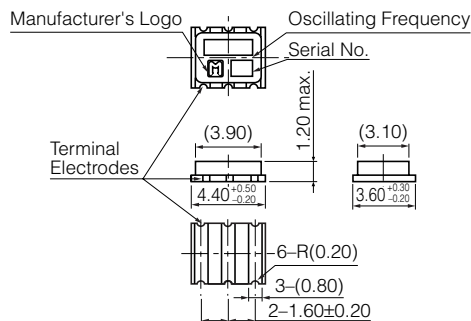

[Type EFOJM]

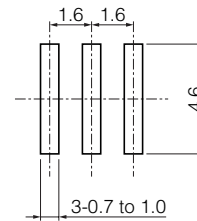

[Type EFOST].....8.00 to 20.0 MHz

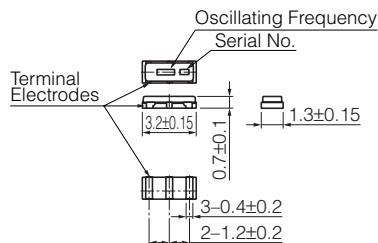

[Type EFOST]

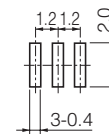

### ■ Test Circuits Diagram

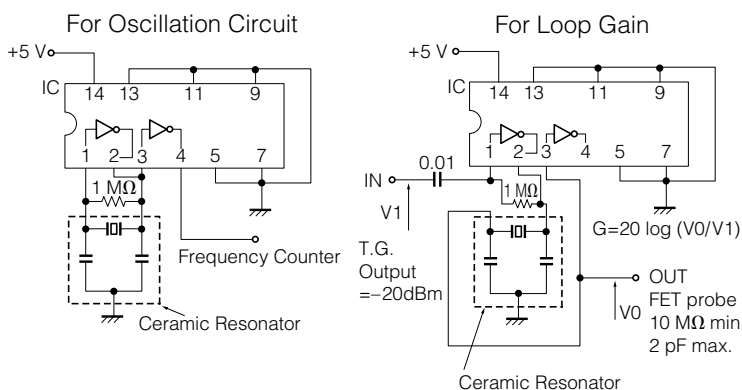

Type	Frequency	IC
Excluding ST	2.00 to 8.39 MHz	μPD4069UBC, TC4069UBP or similar
	8.40 to 50.0 MHz	μPD74HCU, TC74 HCU04AP or similar
ST	8.00 to 12.9 MHz	μPD4069UBC, TC4069UBP or similar
	13.0 to 20.0 MHz	μPD74HCU, TC74 HCU04AP or similar

Design and specifications are each subject to change without notice. Ask factory for the current technical specifications before purchase and/or use. Should a safety concern arise regarding this product, please be sure to contact us immediately.

00 Apr. 2008

### Typical Characteristics ..... Temperature Characteristics

Type EFOS

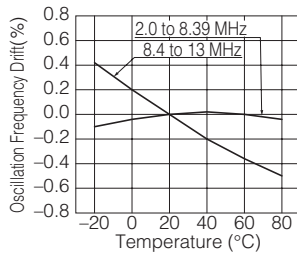

Type EFOB

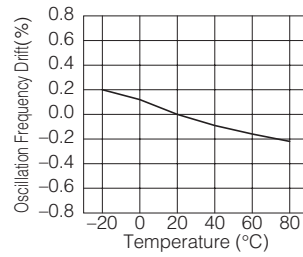

Type EFOSS

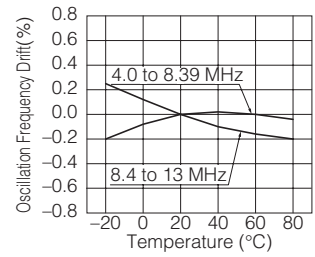

Type EFOSM

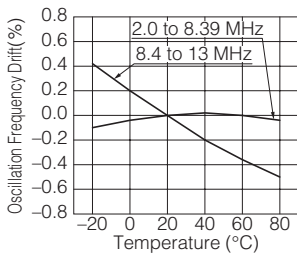

Type EFOBM

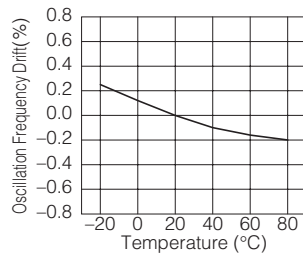

Type EFOJM

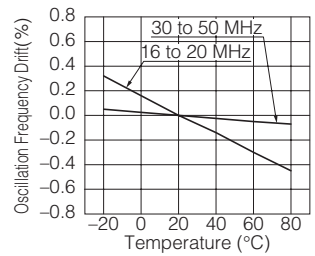

Type EFOST

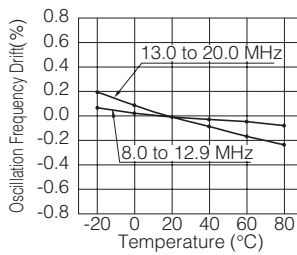

### Packaging Specifications

#### Standard Packing Quantity

Type	Embossed Taping	Bulk
EFOS, EFOSM	2500 pcs./reel	500 pcs./bag
EFOSS	2000 pcs./reel	
EFOB, EFOBM, EFOJM	1000 pcs./reel	
EFOST	3000 pcs./reel	

#### [Type EFOS, EFOSM]

Dim. (mm)	$\phi A$	$\phi B$	C	D	E
	33.0±0.5	80 min.	13.0±0.5	21.0±0.8	2.0±0.5

Dim. (mm)	W	T	t	r
	16.4 <sup>+2.0</sup> <sub>0</sub>	22.4 max.	3 max.	1.0

#### [Type EFOSS, EFOB, EFOBM, EFOJM]

Dim. (mm)	$\phi A$	$\phi B$	C	D	E
	18.0±0.5	60 min.	13.0±0.5	21.0±0.8	2.0±0.5

Dim. (mm)	W	T	t	r
	12.4 <sup>+2.0</sup> <sub>0</sub>	18.4 max.	3 max.	1.0

#### [Type EFOST]

Dim. (mm)	$\phi A$	$\phi B$	C	D	E
	18.0±0.5	60 min.	13.0±0.2	21.0±0.8	2.0±0.5

Dim. (mm)	W	T	t	r
	8.4 <sup>+2.0</sup> <sub>0</sub>	14.0 max.	2.5 max.	1.0

#### Dimensions for Reel in mm (not to scale)

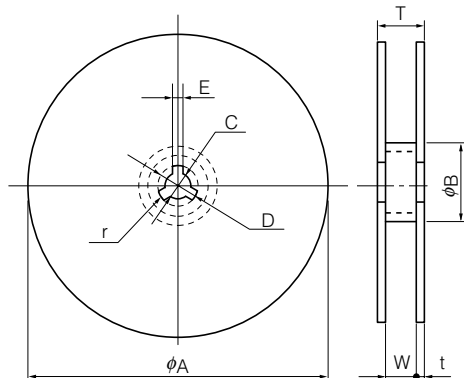

### [Type EFOS, EFOSM]

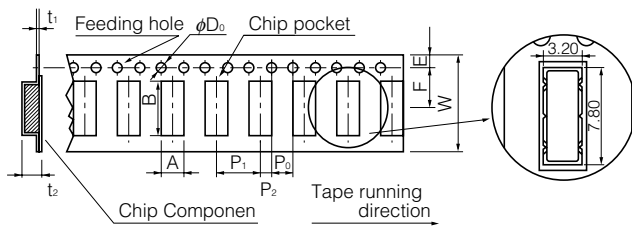

Dim. (mm)	A	B	W	F	E	P <sub>1</sub>
	3.7±0.2	8.3±0.2	16.0±0.3	7.5±0.1	1.75±0.10	8.0±0.1
Dim. (mm)	P <sub>2</sub>	P <sub>0</sub>	φD <sub>0</sub>	t <sub>1</sub>	t <sub>2</sub>	
	2.0±0.1	4.0±0.1	1.5 <sup>+0.1</sup> <sub>0</sub>	0.3	3.5 max.	

### [Type EFOSS]

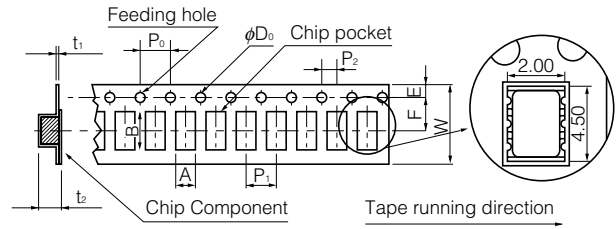

Dim. (mm)	A	B	W	F	E	P <sub>1</sub>
	2.6±0.2	5.1±0.2	12.0±0.3	5.5±0.1	1.75±0.10	4.0±0.1
Dim. (mm)	P <sub>2</sub>	P <sub>0</sub>	φD <sub>0</sub>	t <sub>1</sub>	t <sub>2</sub>	
	2.0±0.1	4.0±0.1	1.5 <sup>+0.1</sup> <sub>0</sub>	0.6 max.	3.0 max.	

### [Type EFOB, EFOBM, EFOJM]

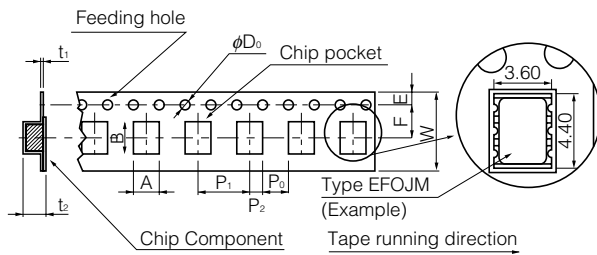

Dim. (mm)	A	B	W	F	E	P <sub>1</sub>
	①	②	12.0±0.3	5.5±0.1	1.75±0.10	8.0±0.1
Dim. (mm)	P <sub>2</sub>	P <sub>0</sub>	φD <sub>0</sub>	t <sub>1</sub>	t <sub>2</sub>	
	2.0±0.1	4.0±0.1	1.5 <sup>+0.1</sup> <sub>0</sub>	0.6 max.	3.0 max.	

### [Type EFOST]

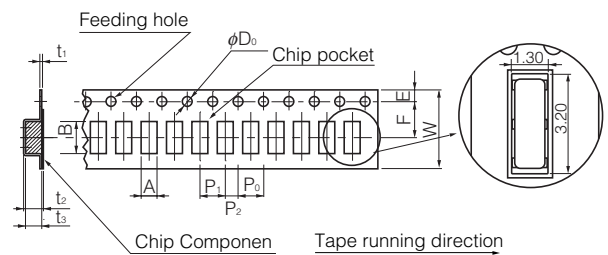

Dim. (mm)	A	B	W	F	E	P <sub>1</sub>
	1.5±0.2	3.4±0.2	8.0±0.2	3.5±0.1	1.75±0.10	4.0±0.1
Dim. (mm)	P <sub>2</sub>	P <sub>0</sub>	φD <sub>0</sub>	t <sub>1</sub>	t <sub>2</sub>	t <sub>3</sub>
	2.0±0.1	4.0±0.1	1.5 <sup>+0.1</sup> <sub>0</sub>	0.35	2.0 max.	(8.0)

Dim. (mm)	A	B
	①	②
Type EFOB	3.7±0.2	6.0±0.2
Type EFOBM	3.4±0.2	4.6±0.2
Type EFOJM	4.1±0.2	4.9±0.2