

Wide Input Range, High Efficiency Step-Down DC/DC Converter

DESCRIPTION

Demonstration circuit 1626A is a dual output 1.5V/15A and 1.2V/15A synchronous buck converter operating with a switching frequency of 300kHz over an input voltage range of 4.5V to 26V. The demo board comes in two versions. The -A version uses inductor DCR current sensing with an iron powder inductor for high efficiency. The -B version uses a 2.5mΩ sense resistor for accurate current sensing with a low DCR ferrite inductor. The fixed on-time valley current mode architecture of the LTC3838 allows for a fast load step response (see Figures 6 to 9). The load step response can be tested with the on-board load step circuit and a bench pulse generator.

The demo board uses a high density, two sided drop-in layout. The entire converter, excluding the bulk output and input capacitors, fits within a compact 1.5" × 1.0" area on the board. The package style for the LTC3838EFE is a 38-lead TSSOP with an exposed ground pad.

The main features of the board are listed below:

- MODE jumper to program either DCM or FCM at light or no load
- EXTVCC pin
- PLLIN pin to synchronize the converter to an external clock
- Remote sensing for V_{OUT1}
- Optional resistors to tie the two phases together
- Each rail has its own RUN pin, PGOOD pin and TRACK/SS pin

Design files for this circuit board are available at <http://www.linear.com/demo>

LT, LT, LTC, LTM, μModule, Linear Technology and the Linear logo are registered trademarks of Linear Technology Corporation. All other trademarks are the property of their respective owners.

PERFORMANCE SUMMARY ($T_A = 25^\circ\text{C}$)

PARAMETER	CONDITION	VALUE
Minimum Input Voltage		4.5V
Maximum Input Voltage		26V
Output Voltage V_{OUT1}	$I_{OUT1} = 0\text{A to }15\text{A}, V_{IN} = 4.5\text{V to }26\text{V}$	1.2V ±2%
Output Voltage V_{OUT2}	$I_{OUT2} = 0\text{A to }15\text{A}, V_{IN} = 4.5\text{V to }26\text{V}$	1.5V ±2%
V_{OUT1} Maximum Output Current, I_{OUT1}	$V_{IN} = 4.5\text{V to }26\text{V}, V_{OUT1} = 1.2\text{V}$	15A
V_{OUT2} Maximum Output Current, I_{OUT2}	$V_{IN} = 4.5\text{V to }26\text{V}, V_{OUT2} = 1.5\text{V}$	15A
Nominal Switching Frequency		300kHz
-A Efficiency See Figures 2 and 3	$V_{OUT1} = 1.2\text{V}, I_{OUT1} = 15\text{A}, V_{IN} = 12\text{V}$	89.1% Typical
	$V_{OUT2} = 1.5\text{V}, I_{OUT2} = 15\text{A}, V_{IN} = 12\text{V}$	90.2% Typical
-B Efficiency See Figures 4 and 5	$V_{OUT1} = 1.2\text{V}, I_{OUT1} = 15\text{A}, V_{IN} = 12\text{V}$	85.9%
	$V_{OUT2} = 1.5\text{V}, I_{OUT2} = 15\text{A}, V_{IN} = 12\text{V}$	88.2%

QUICK START PROCEDURE

Demonstration circuit 1626A is easy to set up to evaluate the performance of the LTC3838EFE. Please refer to Figure 1 for proper measurement equipment setup and follow the procedure below.

1. With power off, connect the input supply, load and meters as shown in Figure 1. Preset the load to 0A and V_{IN} supply to be 0V. Place jumpers in the following positions:

JP4 RUN1 ON

JP1 RUN2 ON

JP3 MODE FCM

2. Adjust the input voltage to be between 4.5V to 26V.
 V_{OUT1} should $1.2V \pm 2\%$.
 V_{OUT2} should $1.5V \pm 2\%$.
3. Next, apply 15A load and recheck V_{OUT} .
4. Once the DC regulation is confirmed, observe the output voltage ripple, load step response, efficiency and other parameters.

Note 1. Use the BNC connectors labeled V_{OUT1} or V_{OUT2} to measure the output voltage ripple.

Note 2. Do not apply the load from the $VO1_SNS+$ turret to the $VO1_SNS-$ turret or from the $VO2+$ turret to the $VO2-$ turret. These turrets are only intended to monitor the voltage across $COU1$ and $COU5$ respectively. Heavy load currents applied across these turrets may damage the converter.

Load Step Transient Testing

Demonstration circuit 1626A provides a simple load step circuit consisting of a MOSFET and sense resistor for each rail. To apply a load step, follow the steps below.

1. Preset the amplitude of a pulse generator to 0.0V and the duty cycle to 5% or less.
2. Connect the scope to the V_{OUT} BNC connectors for the rail under test with a coax cable. To monitor the load step current, connect the scope probe across the I_{STEP+}/I_{STEP-} turrets for that rail.
3. Connect the output of the pulse generator to the PULSE GEN turret for the rail under test and connect the return to one of the GND turrets.
4. With the converter running, slowly increase the amplitude of the pulse generator output to provide the desired load step pulse height. The scaling for the LOAD STEP signal is 10mV/A.

QUICK START PROCEDURE

Single Output/Dual Phase Operation

A single output/dual phase converter may be preferred for high output current applications. The benefits of single output/dual phase operation is lower ripple current through the input and output capacitors, faster load step response and simplified thermal design. To implement single output/dual phase operation, make the following modifications:

- Tie V_{OUT1} to V_{OUT2} by tying together the exposed copper pads on the V_{OUT} shapes with pieces of heavy copper foil.
- Tie VFB2 to INTVCC by stuffing 0Ω at R1. This will disable the error amp for phase 2 and internally tie the two ITH signals together.
- Remove the ITH compensation network, VFB divider and TRACK/SS cap for phase 2.
- Tie VRNG1 to VRNG2 by stuffing 0Ω at R4.
- Tie RUN1 to RUN2 by stuffing 0Ω at R7.
- If the optional transient detect circuit is used, externally tie the DTR1 pin to the DTR2 pin.
- Re-compensate if necessary.

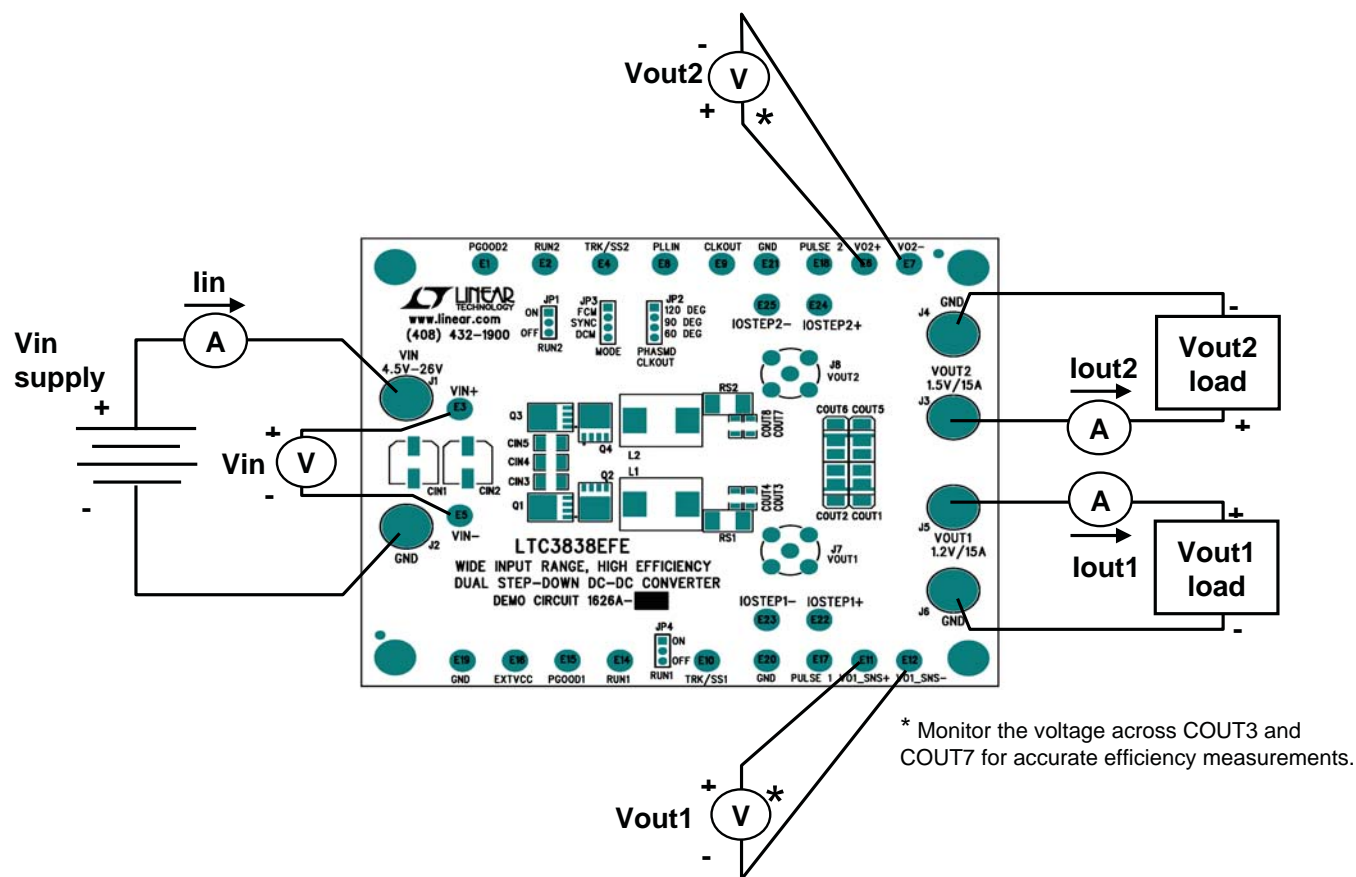
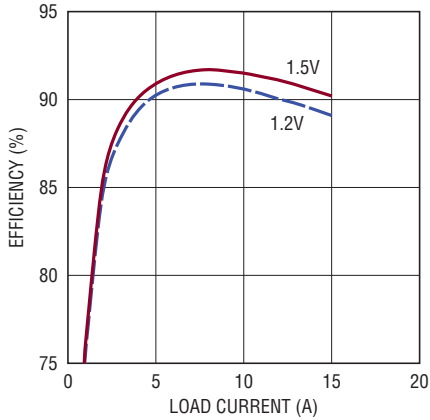

Figure 1. Proper Measurement Equipment Setup

QUICK START PROCEDURE



BOTH RAILS:
 QTOP = RJK0305DPB
 QBOTTOM = RJK0330DPB
 L = VISHAY IHLP4040DZ-01 0.56μH
 DCR = 1.7mΩ TYP, 1.8mΩ MAX

dc1626a F02

Figure 2. Efficiency Curves for the DC1626A-A (DCR Sense) in FCM

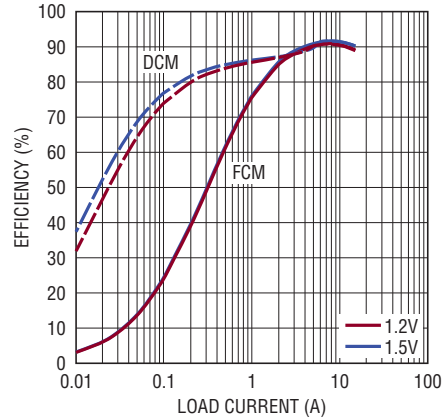

BOTH RAILS:
 QTOP = RJK0305DPB
 QBOTTOM = RJK0330DPB
 L = VISHAY IHLP4040DZ-01 0.56μH
 DCR = 1.7mΩ TYP, 1.8mΩ MAX

dc1626a F03

Figure 3. Efficiency Curves for the DC1626A-A (DCR Sense) in FCM and DCM.

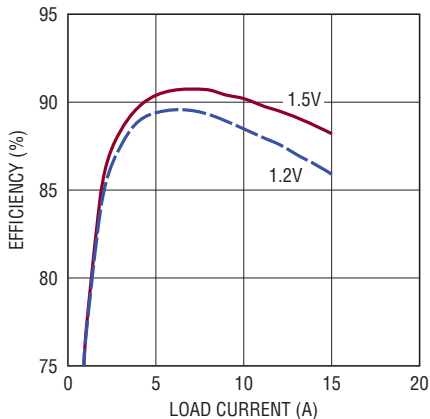

BOTH RAILS:
 QTOP = RJK0305DPB
 QBOTTOM = RJK0330DPB
 L = WURTH 7443330068 0.68μH
 DCR = 1.35mΩ ±10%
 RSENSE = 2.5mΩ

dc1626a F04

Figure 4. Efficiency Curves for the DC1626A-B (RSENSE) in FCM

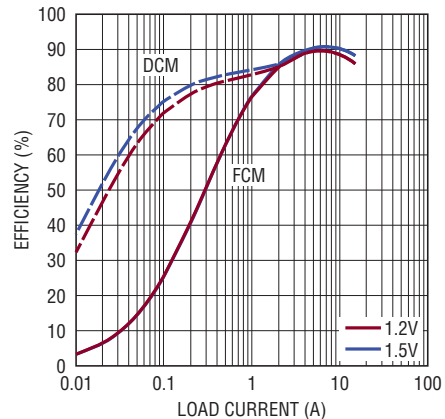

BOTH RAILS:
 QTOP = RJK0305DPB
 QBOTTOM = RJK0330DPB
 L = WURTH 7443330068 0.68μH
 DCR = 1.35mΩ ±10%
 RSENSE = 2.5mΩ

dc1626a F05

Figure 5. Efficiency Curves for the DC1626A-B (RSENSE) in FCM and DCM

QUICK START PROCEDURE

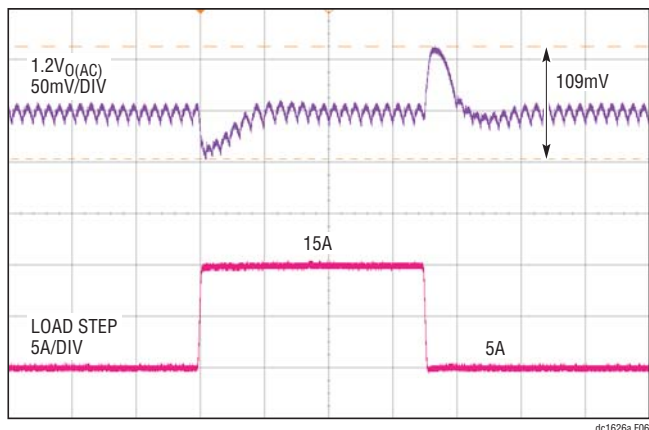

Figure 6. Load Step Response of the 1.2V Rail on the DC1626A-A (DCR Sense) at $V_{IN} = 12V$. $C_{OUT} = 2 \times$ Sanyo 2R5TPE330M9 || $2 \times 100\mu F$ X5R 6.3V 1206, $L = 0.56\mu H$, $f_{SW} = 300kHz$

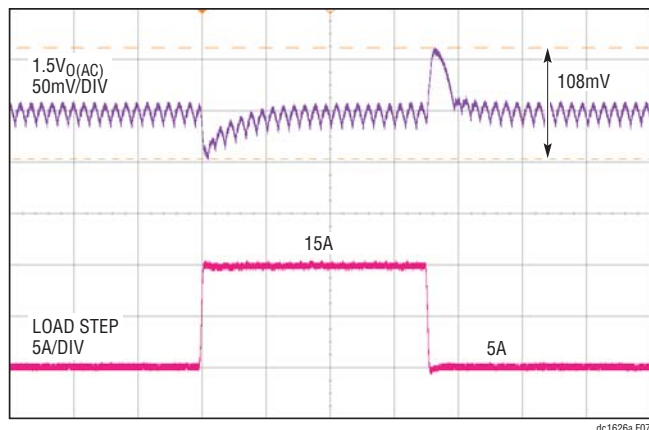

Figure 7. Load Step Response of the 1.5V Rail on the DC1626A-A (DCR Sense) at $V_{IN} = 12V$. $C_{OUT} = 2 \times$ Sanyo 2R5TPE330M9 || $2 \times 100\mu F$ X5R 6.3V 1206, $L = 0.56\mu H$, $f_{SW} = 300kHz$

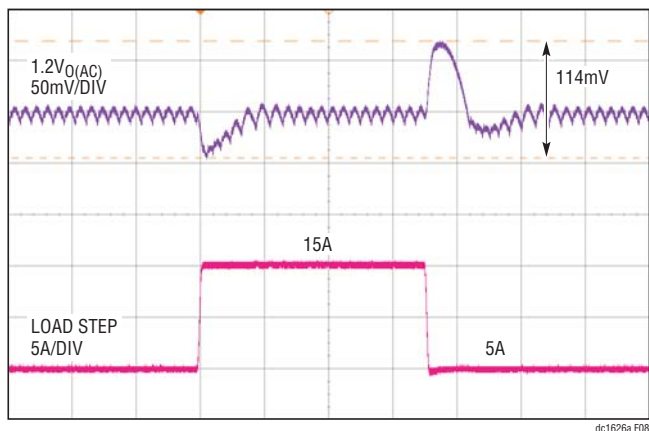

Figure 8. Load Step Response of the 1.2V Rail on the DC1626A-B (R_{SENSE}) At $V_{IN} = 12V$. $C_{OUT} = 2 \times$ Sanyo 2R5TPE330M9 || $2 \times 100\mu F$ X5R 6.3V 1206, $L = 0.68\mu H$, $f_{SW} = 300kHz$

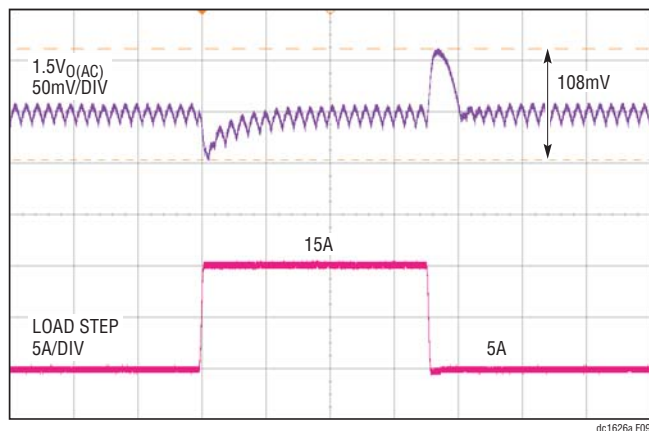

Figure 9. Load Step Response of the 1.5V Rail on the DC1626A-B (R_{SENSE}) at $V_{IN} = 12V$. $C_{OUT} = 2 \times$ Sanyo 2R5TPE330M9 || $2 \times 100\mu F$ X5R 6.3V 1206, $L = 0.68\mu H$, $f_{SW} = 300kHz$

DEMO MANUAL DC1626A

PARTS LIST

1626A-A (DCR Sense)

ITEM	QTY	REFERENCE	PART DESCRIPTION	MANUFACTURER/PART NUMBER
Required Circuit Components				
1	1	C12	CAP, X7R 330pF 50V 0603	AVX 06035C331KAT2A
2	5	C3, C16, C4, C10, C13	CAP, X5R 0.1µF 50V 0603	AVX 06035D104KAT2A
3	2	C5, C14	CAP, X5R 0.01µF 25V 0603	AAC 0603D103KAT2A
4	2	C6, C11	CAP, NPO 47pF 16V 0603	AVX 0603YA470KAT4A
5	1	C7	CAP, NPO 220pF 25V 0603	AVX 06033A221KAT2A
6	1	C8	CAP, X5R 4.7µF 16V 0805	AVX 0805YD475KAT2A
7	2	C9, C18	CAP, X5R 1µF 16V 0603	AVX 0603YD105KAT2A
8	2	CIN1, CIN2	CAP, 100µF 35V SIZE-F	SUNCON 35HVH100M
9	3	CIN3, CIN4, CIN5	CAP, X5R 10µF 35V 1210	TAIYO YUDEN GMK325BJ106MN-T
10	4	COUT1, COUT2, COUT5, COUT6	CAP, 330µF 2.5V SIZE 7343	SANYO 2R5TPE330M9
11	4	COUT3, COUT4, COUT7, COUT8	CAP, X5R 100µF 6.3V 1206	MURATA GRM31CR60J107ME39L
12	2	D1, D2	DIODE, SCHOTTKY SOD-323	CENTRAL SEMI. CMDSH-4ETR
13	2	L1, L2	IND, 0.56µH	VISHAY IHLP4040DZERR56M01
14	2	Q1, Q3	MOSFET, N-CHANNEL LPAK	RENESAS RJK0305DPB-00-J0
15	2	Q2, Q4	MOSFET, N-CHANNEL LPAK	RENESAS RJK0330DPB-00-J0
16	2	R12, R38	RES, 100k 1% 0603	VISHAY CRCW0603100KFKEA
17	1	R13	RES, 15k 1% 0603	VISHAY CRCW060315K0FKEA
18	4	R17, R23, R40, R46	RES, 10k 1% 0603	VISHAY CRCW060310K0FKEA
19	2	R18, R32	RES, 4.02k 1% 0603	VISHAY CRCW06034K02FKEA
20	2	R19, R34	RES, 11k 1% 0603	VISHAY CRCW06011K0FKEA
21	1	R21	RES, 40.2k 1%, 0603	VISHAY CRCW060340K2FKEA
22	2	R27, R25	RES, 2.2Ω 1% 0603	VISHAY CRCW06032R20FKEA
23	1	R28	RES, 137k 1% 0603	VISHAY CRCW0603137KFKEA
24	1	R31	RES, 17.4k 1% 0603	VISHAY CRCW06017K4FKEA
25	2	R42, R43	RES, 10Ω 1% 0603	VISHAY CRCW060310R0FKEA
26	9	R8, R11, R16, R35, R39, R48, R55, R20, R36, R30, R26	RES, 0Ω 0603	VISHAY CRCW06030000Z0EA
27	2	RS1, RS2	RES, 0.000Ω 1W 1% 2512	TEPRO RN5326
28	1	U1	LTC3838 38-LEAD TSSOP	LINEAR TECH. LTC3838EFE
Additional Circuit Components				
1	0	C1, C2, C15, C17	CAP, 0603	OPTIONAL
2	0	CIN6-CIN8	CAP, 1210	OPTIONAL
3	0	COUT13-COUT16	CAP, 7343	OPTIONAL
4	0	Q5-Q8	MOSFET, N-CHANNEL LPAK	OPTIONAL
5	0	R1, R4, R7, R9, R47, R14, R15, R24, R29, R41, R45, R3, R6, R10, R37, R44, R49, R50	RES, 0603	OPTIONAL
6	2	Q9, Q10	MOSFET, N-CHANNEL DPAK	VISHAY SUD50N03-12P-E3
7	2	R51, R52	RES, 10k 1% 0603	VISHAY CRCW060310K0FKEA
8	2	R53, R54	RES, 0.01Ω 1/2W 1% 2010	VISHAY WSL2010R0100FEA

PARTS LIST

1626A-A (DCR Sense)

ITEM	QTY	REFERENCE	PART DESCRIPTION	MANUFACTURER/PART NUMBER
Hardware/Components (For Demo Board Only)				
1	4	STAND-OFF	STAND-OFF, NYLON 0.25"	KEYSTONE 8831 (SNAP ON)
2	23	E1-E12, E14-E25	TESTPOINT, TURRET 0.095"	MILL-MAX 2501-2-00-80-00-00-07-0
3	6	J1-J6	JACK, BANANA	KEYSTONE 575-4
4	2	J7, J8	CONN, BNC 5PINS	CONNEX 112404
5	2	JP1, JP4	2MM SINGLE ROW HEADER, 3-PIN	SAMTEC TMM-103-02-L-S
6	4	JP1-JP4	SHUNT	SAMTEC 2SN-BK-G
7	2	JP2, JP3	2MM SINGLE ROW HEADER, 4-PIN	SAMTEC TMM-104-02-L-S

1626A-B (R_{SENSE})

ITEM	QTY	REFERENCE	PART DESCRIPTION	MANUFACTURER/PART NUMBER
Required Circuit Components				
1	1	C12	CAP, X7R 330pF 50V 0603	AVX 06035C331KAT2A
2	2	C3, C16	CAP, X7R 1000pF 16V 0603	AVX 0603YC102KAT2A
3	3	C4, C10, C13	CAP, X5R 0.1µF 50V 0603	AVX 06035D104KAT2A
4	2	C5, C14	CAP, X5R 0.01µF 25V 0603	AAC 0603D103KAT2A
5	2	C6, C11	CAP, NPO 47pF 16V 0603	AVX 0603YA470KAT4A
6	1	C7	CAP, NPO 220pF 25V 0603	AVX 06033A221KAT2A
7	1	C8	CAP, X5R 4.7µF 16V 0805	AVX 0805YD475KAT2A
8	2	C9, C18	CAP, X5R 1µF 16V 0603	AVX 0603YD105KAT2A
9	2	CIN1, CIN2	CAP, 100µF 35V SIZE-F	SUNCON 35HVH100M
10	3	CIN3, CIN4, CIN5	CAP, X5R 10µF 35V 1210	TAIYO YUDEN GMK325BJ106MN-T
11	4	COUT1, COUT2, COUT5, COUT6	CAP, 330µF 2.5V SIZE 7343	SANYO 2R5TPE330M9
12	4	COUT3, COUT4, COUT7, COUT8	CAP, X5R 100µF 6.3V 1206	MURATA GRM31CR60J107ME39L
13	2	D1, D2	DIODE, SCHOTTKY SOD-323	CENTRAL SEMI. CMDSH-4ETR
14	2	L1, L2	IND, 0.68µH	WURTH 7443330068
15	2	Q1, Q3	MOSFET, N-CHANNEL LFPK	RENESAS RJK0305DPB-00-J0
16	2	Q2, Q4	MOSFET, N-CHANNEL LFPK	RENESAS RJK0330DPB-00-J0
17	2	R12, R38	RES, 100k 1% 0603	VISHAY CRCW0603100KFKEA
18	1	R13	RES, 15k 1% 0603	VISHAY CRCW060315K0FKEA
19	4	R14, R15, R41, R45	RES, 10Ω 1% 0603	VISHAY CRCW060310R0FKEA
20	4	R17, R23, R40, R46	RES, 10k 1% 0603	VISHAY CRCW060310K0FKEA
21	1	R21	RES, 45.3k 1% 0603	VISHAY CRCW060345K3FKEA
22	2	R27, R25	RES, 2.2Ω 1% 0603	VISHAY CRCW06032R20FKEA
23	1	R28	RES, 137k 1% 0603	VISHAY CRCW0603137KFKEA
24	1	R31	RES, 20k 1% 0603	VISHAY CRCW060320K0FKEA
25	2	R42, R43	RES, 10Ω 1% 0603	VISHAY CRCW060310R0FKEA
26	9	R8, R11, R16, R35, R39, R48, R55, R24, R29	RES, 0Ω 0603	VISHAY CRCW06030000Z0EA
27	2	RS1, RS2	RES, SENSE 0.0025 2512	VISHAY WSL25122L500FEA
28	1	U1	LTC3838 38-LEAD TSSOP	LINEAR TECH. LTC3838EFE

DEMO MANUAL DC1626A

PARTS LIST

1626A-B (R_{SENSE})

ITEM	QTY	REFERENCE	PART DESCRIPTION	MANUFACTURER/PART NUMBER
Additional Circuit Components				
1	0	C1, C2, C15, C17	CAP, 0603	OPTIONAL
2	0	CIN6-CIN8	CAP, 1210	OPTIONAL
3	0	COU13-COU16	CAP, 7343	OPTIONAL
4	0	Q5-Q8	MOSFET, N-CHANNEL LFPK	OPTIONAL
5	2	Q9, Q10	SUD50N03-12P-E3	VISHAY SUD50N03-12P-E3
6	0	R1, R4, R7, R9, R47, R18, R19, R20, R32, R34, R20, R36, R3, R6, R10, R37, R44, R49, R50, R30, R26	RES, 0603	OPTIONAL
7	2	R51, R52	RES, 10k 1% 0603	VISHAY CRCW060310K0FKEA
8	2	R53, R54	RES, 0.01Ω 1/2W 1% 2010	VISHAY WSL2010R0100FEA
Hardware/Components (For Demo Board Only)				
1	4	STAND-OFF	STAND-OFF, NYLON 0.25"	KEYSTONE, 8831 (SNAP ON)
2	23	E1-E12, E14-E25	TESTPOINT, TURRET 0.095"	MILL-MAX 2501-2-00-80-00-00-07-0
3	6	J1-J6	JACK, BANANA	KEYSTONE 575-4
4	2	J7, J8	CONN, BNC 5-PINS	CONNEX 112404
5	2	JP1, JP4	2MM SINGLE ROW HEADER, 3-PIN	SAMTEC TMM-103-02-L-S
6	4	JP1-JP4	SHUNT	SAMTEC 2SN-BK-G
7	2	JP2, JP3	2MM SINGLE ROW HEADER, 4PIN	SAMTEC TMM-104-02-L-S

SCHEMATIC DIAGRAM

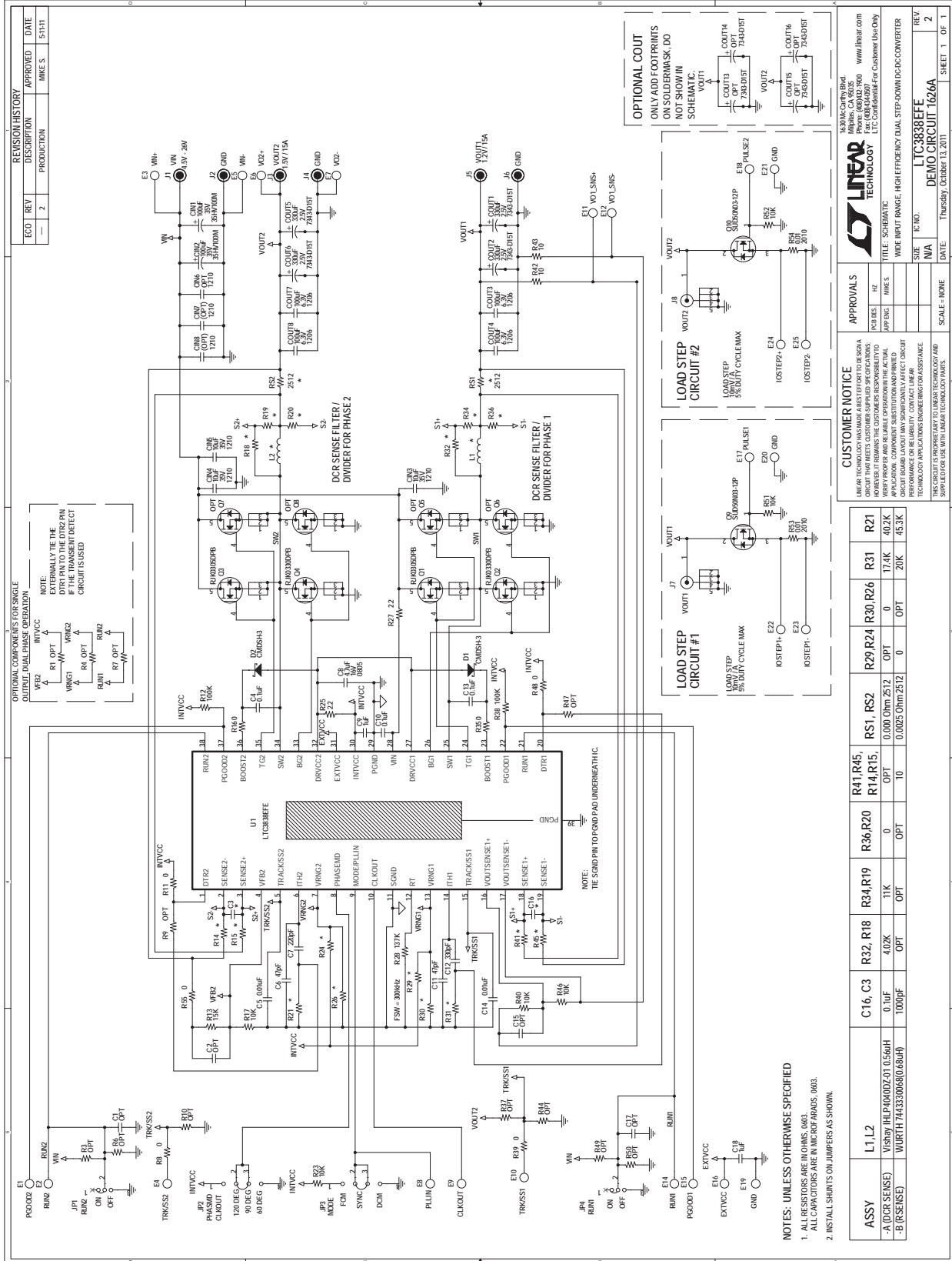

ASSY	L1,L2	C16, C3	R32, R18	R34,R19	R36,R20	R29,R24	R30,R26	R31	R21
-A (DCR SENSE)	WURTH 7443330066(0.056H)	0.1uF	4.03K	11K	0	0.005 Ohm/2512	0	17.4K	40.3K
-B (R-SENSE)	WURTH 7443330066(0.060H)	100uF	OPT	OPT	OPT	0.0025 Ohm/2512	0	20K	45.3K

APPROVALS

PCB DES.	LT	TEST
APP SIG.	MIKE S.	

CUSTOMER NOTICE

LINEAR TECHNOLOGY HAS MADE A BEST EFFORT TO DESIGN A CIRCUIT THAT MEETS CUSTOMER SPECIFIED REQUIREMENTS. HOWEVER, LINEAR TECHNOLOGY DOES NOT WARRANT ANY ACTUAL APPLICATION COMPONENT SUBSTITUTION AND PREFERRED CIRCUIT BOARD LAYOUT (ANALOGOUS TO A PERFECT CIRCUIT) TECHNOLOGY APPLICATIONS ENGINEERING FOR ASSISTANCE. THE CIRCUIT IS PROPRIETARY TO LINEAR TECHNOLOGY AND SUPPLIED FOR USE WITH LINEAR TECHNOLOGY PARTS.

LINEAR TECHNOLOGY
1330 McCarty Blvd.
Foster City, CA 94404
Phone: (650) 945-2900
Fax: (650) 945-0700
www.linear.com
LTC Confidential For Customer Use Only

DEMO CIRCUIT 1626A

DATE: Thursday, October 13, 2011

SHEET 1 OF 1

DEMO MANUAL DC1626A

DEMONSTRATION BOARD IMPORTANT NOTICE

Linear Technology Corporation (LTC) provides the enclosed product(s) under the following **AS IS** conditions:

This demonstration board (DEMO BOARD) kit being sold or provided by Linear Technology is intended for use for **ENGINEERING DEVELOPMENT OR EVALUATION PURPOSES ONLY** and is not provided by LTC for commercial use. As such, the DEMO BOARD herein may not be complete in terms of required design-, marketing-, and/or manufacturing-related protective considerations, including but not limited to product safety measures typically found in finished commercial goods. As a prototype, this product does not fall within the scope of the European Union directive on electromagnetic compatibility and therefore may or may not meet the technical requirements of the directive, or other regulations.

If this evaluation kit does not meet the specifications recited in the DEMO BOARD manual the kit may be returned within 30 days from the date of delivery for a full refund. **THE FOREGOING WARRANTY IS THE EXCLUSIVE WARRANTY MADE BY THE SELLER TO BUYER AND IS IN LIEU OF ALL OTHER WARRANTIES, EXPRESSED, IMPLIED, OR STATUTORY, INCLUDING ANY WARRANTY OF MERCHANTABILITY OR FITNESS FOR ANY PARTICULAR PURPOSE. EXCEPT TO THE EXTENT OF THIS INDEMNITY, NEITHER PARTY SHALL BE LIABLE TO THE OTHER FOR ANY INDIRECT, SPECIAL, INCIDENTAL, OR CONSEQUENTIAL DAMAGES.**

The user assumes all responsibility and liability for proper and safe handling of the goods. Further, the user releases LTC from all claims arising from the handling or use of the goods. Due to the open construction of the product, it is the user's responsibility to take any and all appropriate precautions with regard to electrostatic discharge. Also be aware that the products herein may not be regulatory compliant or agency certified (FCC, UL, CE, etc.).

No License is granted under any patent right or other intellectual property whatsoever. **LTC assumes no liability for applications assistance, customer product design, software performance, or infringement of patents or any other intellectual property rights of any kind.**

LTC currently services a variety of customers for products around the world, and therefore this transaction **is not exclusive**.

Please read the DEMO BOARD manual prior to handling the product. Persons handling this product must have electronics training and observe good laboratory practice standards. **Common sense is encouraged.**

This notice contains important safety information about temperatures and voltages. For further safety concerns, please contact a LTC application engineer.

Mailing Address:

Linear Technology
1630 McCarthy Blvd.
Milpitas, CA 95035

Copyright © 2004, Linear Technology Corporation