

FEATURES

50ns max Switching Time Over Full Temperature Range

Low R_{ON} (30Ω typ)

Single Supply Specifications for +10.8V to +16.5V Operation

Extended Plastic Temperature Range (-40°C to +85°C)

Break-Before-Make Switching

Low Leakage (100pA typ)

44V Supply max Rating

Available in 16-Lead DIP/SOIC and 20-Lead LCCC/PLCC Packages

ADG201HS (K, B, T) Replaces HI-201HS

ADG201HS (J, A, S) Replaces DG271

GENERAL DESCRIPTION

The ADG201HS is a monolithic CMOS device comprising four independently selectable SPST switches. It is designed on an enhanced LC²MOS process which gives very fast switching speeds and low R_{ON}.

The switches also feature break-before-make switching action for use in multiplexer applications and low charge injection for minimum transients on the output when switching the digital inputs.

ORDERING GUIDE

Model ¹	Temperature Range	Package Option ²
ADG201HSJN	-40°C to +85°C	N-16
ADG201HSKN	-40°C to +85°C	N-16
ADG201HSKR	-40°C to +85°C	R-16
ADG201HSAQ	-40°C to +85°C	Q-16
ADG201HSBQ	-40°C to +85°C	Q-16
ADG201HSJP	-40°C to +85°C	P-20A
ADG201HSKP	-40°C to +85°C	P-20A
ADG201HSSQ	-55°C to +125°C	Q-16
ADG201HSTQ ³	-55°C to +125°C	Q-16
ADG201HSTE ³	-55°C to +125°C	E-20A

NOTES

¹To order MIL-STD-883, Class B processed parts, add /883B to T grade part numbers. See the Analog Devices Military Products Databook (1994) for military data sheet.

²E = Leadless Ceramic Chip Carrier; N = Narrow Plastic DIP; P = Plastic Leaded Chip Carrier; Q = Cerdip; R = 0.15" Small Outline IC (SOIC).

³Standard Military Drawing (SMD) approved by DESC. SMD numbers are

5962-86716012X (ADG201HSTE/883B)

5962-8671601EX (ADG201HSTQ/883B)

REV. B

Information furnished by Analog Devices is believed to be accurate and reliable. However, no responsibility is assumed by Analog Devices for its use, nor for any infringements of patents or other rights of third parties which may result from its use. No license is granted by implication or otherwise under any patent or patent rights of Analog Devices.

FUNCTIONAL BLOCK DIAGRAM

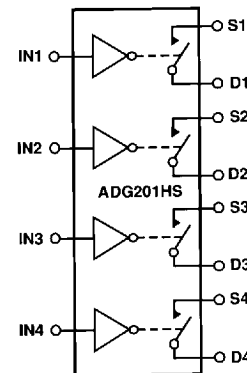

PRODUCT HIGHLIGHTS

1. 50ns max t_{ON} and t_{OFF}:

The ADG201HS top grades (K, B, T) have guaranteed 50ns max turn-on and turn-off times over the full operating temperature range. The lower grades (J,A,S) have guaranteed 75ns switching times over the full operating temperature range.

2. Single Supply Specifications:

The ADG201HS is fully specified for applications which require a single positive power supply in the +10.8V to +16.5V range.

3. Low Leakage:

Leakage currents in the range of 100pA make these switches suitable for high precision circuits. The added feature of break-before-make allows for multiple outputs to be tied together for multiplexer applications while keeping leakage errors to a minimum.

IN	Switch Condition
0	ON
1	OFF

Truth Table

ADG201HS — SPECIFICATIONS

DUAL SUPPLY ($V_{DD} = +13.5V$ to $+16.5V$, $= -13.5V$ to $-16.5V$, $GND = 0V$,
 $V_{IN} = 3V$ [Logic High Level] or $0.8V$ [Logic Low Level] unless otherwise noted)

Parameter	Version	+25°C	$T_{min} - T_{max}^1$	Units	Comments
ANALOG SWITCH					
Analog Signal Range	All	V_{SS}	V_{SS}	V min	
	All	V_{DD}	V_{DD}	V max	
R_{ON}	All	30	—	Ω typ	$-10V \leq V_S \leq +10V$, $I_{DS} = 1mA$; Test Circuit 1
	All	50	75	Ω max	
R_{ON} Drift	All	0.5	—	%/°C typ	$-10V \leq V_S \leq +10V$, $I_{DS} = 1mA$
R_{ON} Match	All	3	—	% typ	$-10V \leq V_S \leq +10V$, $I_{DS} = 1mA$
I_S (OFF), Off Input Leakage ²	All	0.1	—	nA typ	$V_D = \pm 14V$; $V_S = \mp 14V$; Test Circuit 2
	J, K, A, B	1	20	nA max	
	S, T	1	60	nA max	
I_D (OFF), Off Output Leakage ²	All	0.1	—	nA typ	$V_D = \pm 14V$; $V_S = \mp 14V$; Test Circuit 2
	J, K, A, B	1	20	nA max	
	S, T	1	60	nA max	
I_D (ON), On Channel Leakage ²	All	0.1	—	nA typ	$V_D = V_S = \pm 14V$; Test Circuit 3
	J, K, A, B	1	20	nA max	
	S, T	1	60	nA max	
DIGITAL CONTROL					
V_{INH} , Input High Voltage	All	2.4	2.4	V min	
V_{INL} , Input Low Voltage	All	0.8	0.8	V max	
I_{INL} or I_{INH}	All	1	1	μA max	
C_{IN}	All	8	8	pF max	
DYNAMIC CHARACTERISTICS					
t_{ON}	K, B, T	50	50	ns max	Test Circuit 4
	J, A, S	75	75	ns max	
t_{OFF1}	K, B, T	50	50	ns max	Test Circuit 4
	J, A, S	75	75	ns max	
t_{OFF2}	All	150	—	ns typ	Test Circuit 4
t_{OPEN}	All	5	5	ns typ	$t_{ON} - t_{OFF1}$; Test Circuit 4
Output Settling Time to 0.1%	All	180	—	ns typ	$V_{IN} = 3V$ to $0V$; Test Circuit 4
OFF Isolation	All	72	—	dB typ	$V_S = 3V$ rms, $f = 100kHz$, $R_L = 1k\Omega$; $C_L = 10pF$; Test Circuit 5
Channel-to-Channel Crosstalk	All	86	—	dB typ	$V_S = 3V$ rms, $f = 100kHz$, $R_L = 1k\Omega$; $C_L = 10pF$; Test Circuit 6
Q_{INJ} , Charge Injection	All	10	—	pC typ	$R_S = 0\Omega$, $V_S = 0V$; Test Circuit 7
C_S (OFF)	All	10	—	pF typ	
C_D (OFF)	All	10	—	pF typ	
C_D , C_S (ON)	All	30	—	pF typ	
C_{DS} (OFF)	All	0.5	—	pF typ	
POWER SUPPLY					
I_{DD}	All	10	10	mA max	
I_{SS}	All	6	6	mA max	
Power Dissipation	All	240	240	mW max	$V_{DD} = +15V$, $V_{SS} = -15V$

NOTES

¹Temperature ranges are as follows: ADG201HSJ, K; $-40^\circ C$ to $+85^\circ C$
 ADG201HSA, B; $-40^\circ C$ to $+85^\circ C$
 ADG201HSS, T; $-55^\circ C$ to $+125^\circ C$

²Leakage specifications apply with a V_D (V_S) of $\pm 14V$ or with a V_D (V_S) of $0.5V$ within the supply voltages (V_{DD} , V_{SS}), whichever is the minimum.
 Specifications subject to change without notice.

SINGLE SUPPLY ($V_{DD} = +10.8V$ to $+16.5V$, $V_{SS} = GND = 0V$, $V_{IN} = 3V$ [Logic High Level] or $0.8V$ [Logic Low Level] unless otherwise noted)

Parameter	Version	+25°C	$T_{min} - T_{max}$	Units	Comments
ANALOG SWITCH					
Analog Signal Range	All	V_{SS}	V_{SS}	V min	
	All	V_{DD}	V_{DD}	V max	
R_{ON}	All	65	–	Ω typ	$0V \leq V_S \leq +10V$, $I_{DS} = 1mA$; Test Circuit 1
	All	90	120	Ω max	
R_{ON} Drift	All	0.5	–	%/°C typ	$0V \leq V_S \leq +10V$, $I_{DS} = 1mA$
R_{ON} Match	All	3	–	% typ	$0V \leq V_S \leq +10V$, $I_{DS} = 1mA$
I_S (OFF), Off Input Leakage ¹	All	0.1	–	nA typ	$V_D = +10V/+0.5V$; $V_S = +0.5V/+10V$; Test Circuit 2
	J, K, A, B	1	20	nA max	
	S, T	1	60	nA max	
I_D (OFF), Off Output Leakage ¹	All	0.1	–	nA typ	$V_D = +10V/+0.5V$; $V_S = +0.5V/+10V$; Test Circuit 2
	J, K, A, B	1	20	nA max	
	S, T	1	60	nA max	
I_D (ON), On Channel Leakage ¹	All	0.1	–	nA typ	$V_D = V_S = +10V/+0.5V$; Test Circuit 3
	J, K, A, B	1	20	nA max	
	S, T	1	60	nA max	
DIGITAL CONTROL					
V_{INH} , Input High Voltage	All	2.4	2.4	V min	
V_{INL} , Input Low Voltage	All	0.8	0.8	V max	
I_{INL} or I_{INH}	All	1	1	μA max	
C_{IN}	All	8	8	pF max	
DYNAMIC CHARACTERISTICS					
t_{ON}	K, B, T	50	70	ns max	Test Circuit 4
	J, A, S	75	90	ns max	
t_{OFF1}	K, B, T	50	70	ns max	Test Circuit 4
	J, A, S	75	90	ns max	
t_{OFF2}	All	150	–	ns typ	Test Circuit 4
t_{OPEN}	All	5	5	ns typ	$t_{ON} - t_{OFF1}$; Test Circuit 4
Output Settling Time to 0.1%	All	180	–	ns typ	$V_{IN} = 3V$ to $0V$; Test Circuit 4
OFF Isolation	All	72	–	dB typ	$V_S = 3V$ rms, $f = 100kHz$, $R_L = 1k\Omega$; $C_L = 10pF$; Test Circuit 5
Channel-to-Channel Crosstalk	All	86	–	dB typ	$V_S = 3V$ rms, $f = 100kHz$, $R_L = 1k\Omega$; $C_L = 10pF$; Test Circuit 6
Q_{INJ} , Charge Injection	All	10	–	pC typ	$R_S = 0\Omega$, $V_S = 0V$; Test Circuit 7
C_S (OFF)	All	10	–	pF typ	
C_D (OFF)	All	10	–	pF typ	
C_D , C_S (ON)	All	30	–	pF typ	
C_{DS} (OFF)	All	0.5	–	pF typ	
POWER SUPPLY					
I_{DD}	All	10	10	mA max	
Power Dissipation	All	150	150	mW max	$V_{DD} = +15V$

NOTE

¹The leakage specifications degrade marginally (typically 1nA at 25°C) with $V_D(V_S) = V_{SS}$.

Specifications subject to change without notice.

ADG201HS

ABSOLUTE MAXIMUM RATINGS*

(T_A = 25°C unless otherwise noted)

V _{DD} to V _{SS}	44V
V _{DD} to GND	-0.3V, 25V
V _{SS} to GND ¹	+0.3V, -25V
Analog Inputs ²	
Voltage at S, D	V _{SS} - 2V to V _{DD} + 2V or 20mA, Whichever Occurs First
Continuous Current, S or D	20mA
Pulsed Current S or D	20mA
I _{ms} Duration, 10% Duty Cycle	70mA
Digital Inputs ²	
Voltage at IN	V _{SS} - 4V to V _{DD} + 4V or 20mA, Whichever Occurs First

Power Dissipation (Any Package)

Up to +75°C	470mW
Derates above +75°C by	6mW/°C

Operating Temperature

Commerical (J, K Version)	-40°C to +85°C
Industrial (A, B Version)	-40°C to +85°C
Extended (S, T Version)	-55°C to +125°C
Storage Temperature Range	-65°C to +150°C
Lead Temperature (Soldering 10sec)	+300°C

NOTES

¹If V_{SS} is open circuited with V_{DD} and GND applied, the V_{SS} pin will be pulled positive, exceeding the Absolute Maximum Ratings. If this possibility exists, a Schottky diode from V_{SS} to GND (cathode end to GND) ensures that the Absolute Maximum Ratings will be observed.

²Overtoltage at IN, S or D, will be clamped by diodes. Current should be limited to the maximum rating above.

*COMMENT: Stresses above those listed under "Absolute Maximum Ratings" may cause permanent damage to the device. This is a stress rating only and functional operation of the device at these or any other conditions above those indicated in the operational sections of this specification is not implied. Exposure to absolute maximum rating conditions for extended periods may affect device reliability.

CAUTION:

ESD (electrostatic discharge) sensitive device. The digital control inputs are diode protected; however, permanent damage may occur on unconnected devices subject to high energy electrostatic fields. Unused devices must be stored in conductive foam or shunts. The protective foam should be discharged to the destination socket before devices are inserted.



PIN CONFIGURATIONS



Typical Performance Characteristics—ADG201HS

The switches are guaranteed functional with reduced single or dual supplies down to 4.5V.

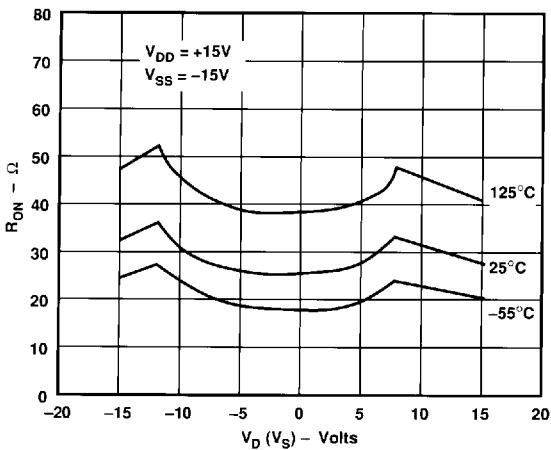

R_{ON} as a Function of V_D (V_S): Dual Supply Voltage

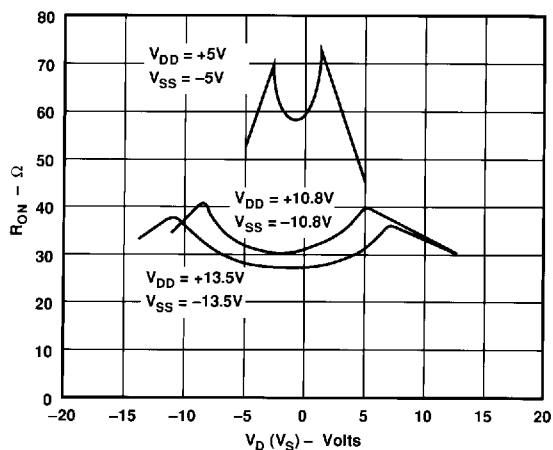

R_{ON} as a Function of V_D (V_S): Dual Supply Voltage, $T_A = +25^\circ C$

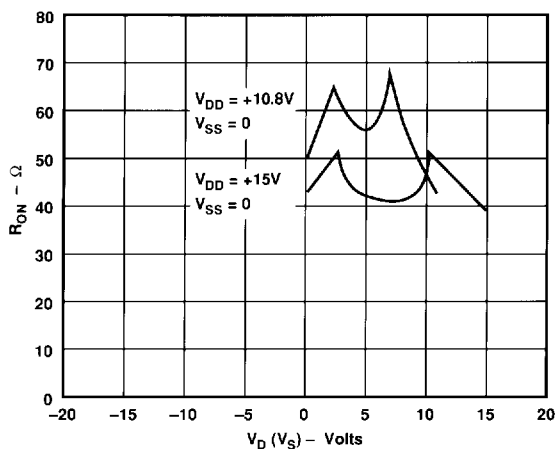

R_{ON} as a Function of V_D (V_S): Single Supply Voltage, $T_A = +25^\circ C$

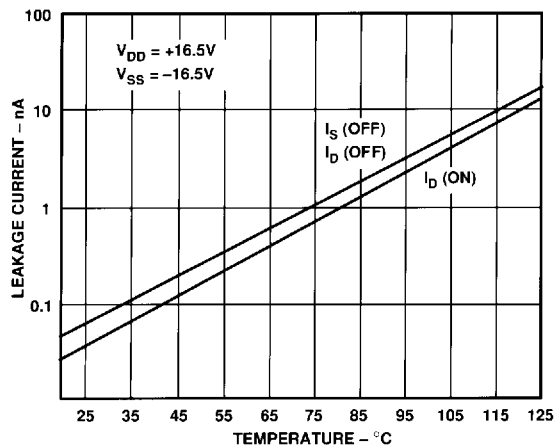

Leakage Current as a Function of Temperature Dual Supply Voltage. (Note: Leakage Currents Reduce as the Supply Voltages Reduce)

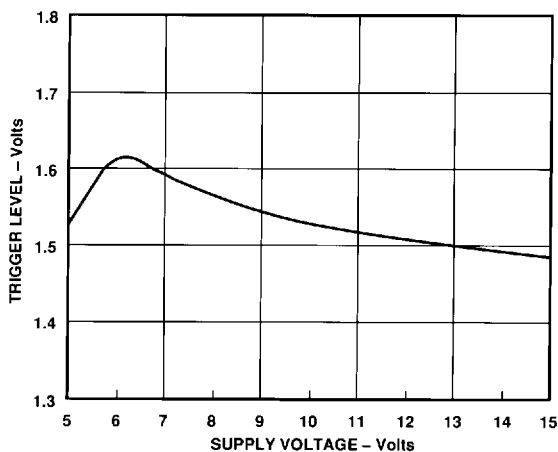

Trigger Levels vs. Power Supply Voltage, Dual or Single Supply, $T_A = +25^\circ C$



Off Isolation vs. Signal Frequency; Dual or Single 15V Supplies, $T_A = +25^\circ C$

ADG201HS—Typical Performance Characteristics (Continued)

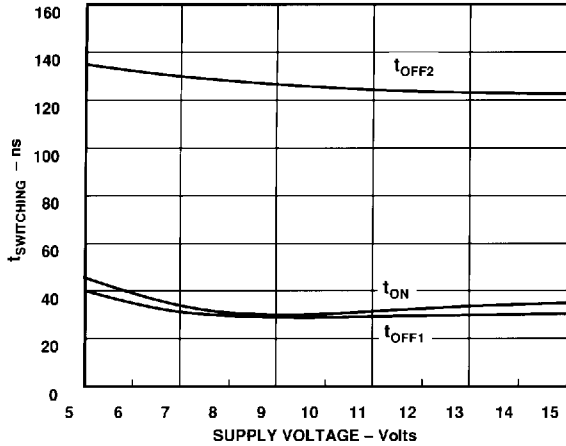

Switching Time vs. Supply Voltage (Dual Supply):
 $T_A = +25^\circ\text{C}$. (Note: See Test Circuit 4.
 For $V_{DD} < 10\text{V}$, $V_S = V_{DD}$)



Switching Time vs. Supply Voltage (Single Supply):
 $T_A = +25^\circ\text{C}$. (Note: See Test Circuit 4.
 For $V_{DD} < 10\text{V}$, $V_S = V_{DD}$)



Switching Time vs. Temperature: Dual Supply Voltage

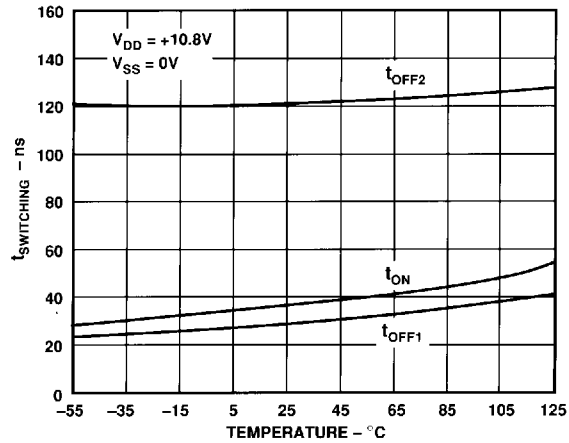

Switching Time vs. Temperature: Single Supply Voltage

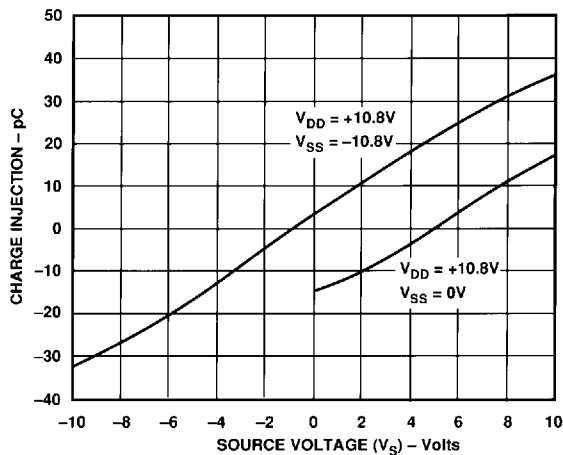

Charge Injection vs. Source Voltage (V_S) for Dual and Single 10.8V Supplies: $T_A = +25^\circ\text{C}$

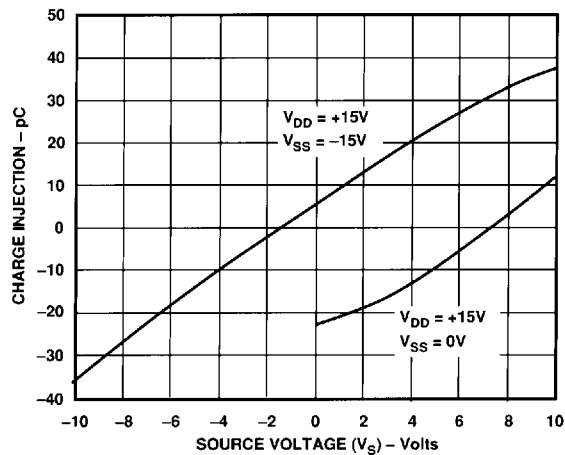

Charge Injection vs. Source Voltage (V_S) for Dual and Single 15V Supplies: $T_A = +25^\circ\text{C}$

Test Circuits—ADG201HS

Note: All digital input signal rise and fall times measured from 10% to 90% of 3V. $t_R = t_F = 5\text{ns}$. Decoupling capacitors ($0.01\mu\text{F}$ min) from V_{DD} and V_{SS} to GND are recommended to achieve specified performance.

TEST CIRCUIT 1
 R_{ON}

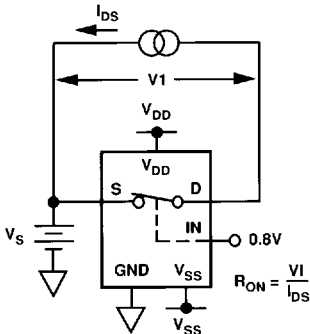

TEST CIRCUIT 2
 $I_S(\text{OFF}), I_D(\text{OFF})$

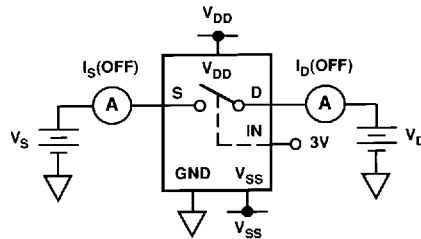

TEST CIRCUIT 3
 $I_D(\text{ON})$

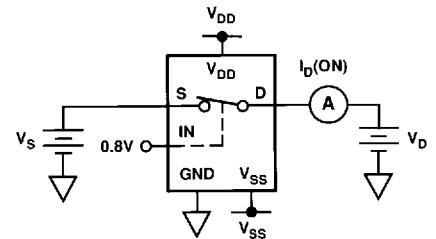

TEST CIRCUIT 4
 $t_{ON}, t_{OFF}, t_{OPEN}, \text{SETTLING TIME}$



TEST CIRCUIT 5
OFF ISOLATION



TEST CIRCUIT 6
CHANNEL-TO-CHANNEL CROSSTALK

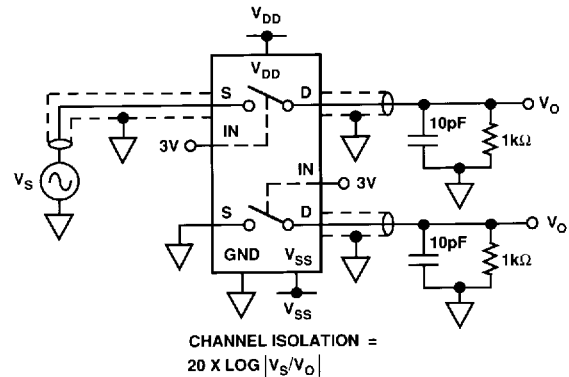

TEST CIRCUIT 7
CHARGE INJECTION

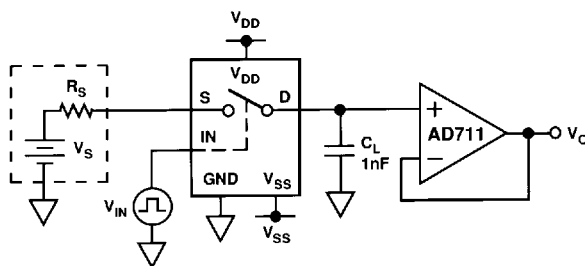

ADG201HS

SINGLE SUPPLY DISK DRIVE APPLICATION

The excellent performance of the ADG201HS with single supply operation makes it suitable in applications such as disk drives where only positive power supply voltages are normally available. The accompanying circuit shows a typical application for the ADG201HS in the read/write head switching section of a disk drive. The circuit allows data (0s and 1s) to be written to and read from a disk. The principal advantage offered by the ADG201HS is that it retains very fast switching speed with single supply operation (see Single Supply Specifications). This allows disk drives to run at higher data rates.

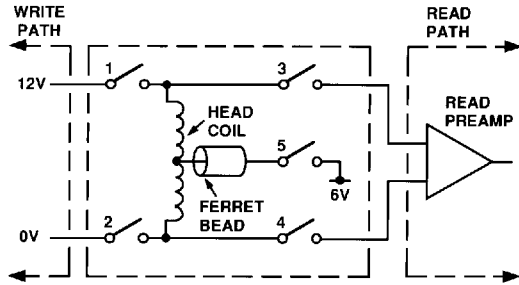

SWITCHES 1 TO 5 ALL ADG201HS

SWITCH NUMBER	WRITE		READ
	"0"	"1"	
1	OFF	ON	OFF
2	ON	OFF	OFF
3	OFF	OFF	ON
4	OFF	OFF	ON
5	ON	ON	OFF

ADG201HS in the Read/Write Head Switching Circuit of a Disk Drive

OUTLINE DIMENSIONS

Dimensions shown in inches and (mm).

20-Terminal Plastic Leaded Chip Carrier (P-20A)

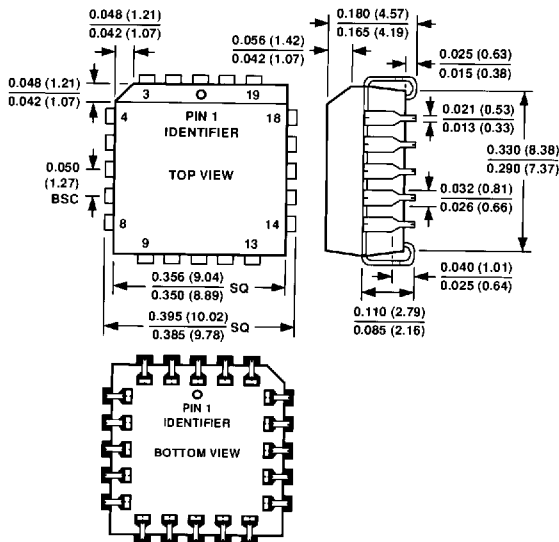

16-Pin Plastic DIP (N-16)

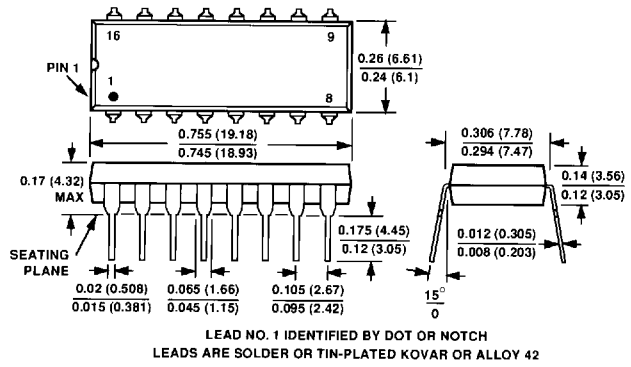

LEAD NO. 1 IDENTIFIED BY DOT OR NOTCH
LEADS ARE SOLDER OR TIN-PLATED KOVAR OR ALLOY 42

16-Pin Cerdip (Q-16)

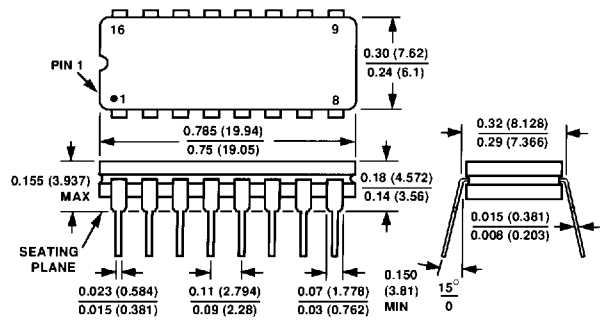

LEAD NO. 1 IDENTIFIED BY DOT OR NOTCH
LEADS ARE SOLDER OR TIN-PLATED KOVAR OR ALLOY 42

16-Lead Narrow Body SOIC (R-16A)

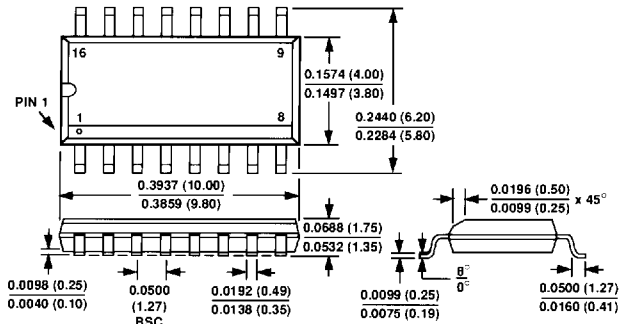

20-Terminal Leadless Ceramic Chip Carrier (E-20A)

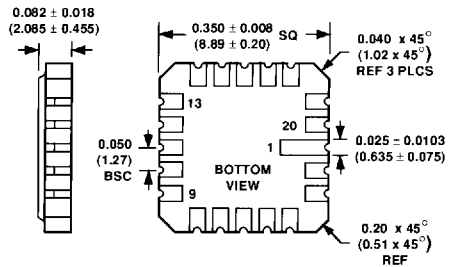

C1178-10-4 RR

PRINTED IN U.S.A.