

DSS6NC52A101Q55#

“#” indicates a package specification code.



< List of part numbers with package codes >
DSS6NC52A101Q55B

Appearance & Shape

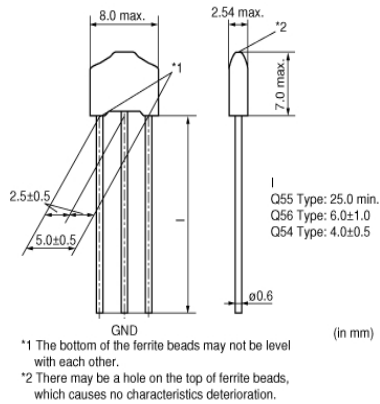

Features

DS_6 is a compact, high performance lead type EMI suppression filter which can be mounted 2.54mm pitch. Its three terminal structure enables precise high frequency performance.

Applications

Other Usage	For general
-------------	-------------

Packaging Information

Packaging	Specifications	Standard Packing Quantity
B	Bulk(Bag)	250

Attention
1.This datasheet is downloaded from the website of Murata Manufacturing Co., Ltd. Therefore, it's specifications are subject to change or our products in it may be discontinued without advance notice. Please check with our sales representatives or product engineers before ordering.
2.This datasheet has only typical specifications because there is no space for detailed specifications.
Therefore, please review our product specifications or consult the approval sheet for product specifications before ordering.

DSS6NC52A101Q55#

“#” indicates a package specification code.

Specifications

Shape	Lead
Length	8.0mm
Length Tolerance	max.
Width	2.54mm
Width Tolerance	max.
Thickness	7.0mm
Thickness Tolerance	max.
Rated Current	6A
Operating Temperature Range	-25°C to 85°C
Mass(typ.)	0.42g
Number of Circuit	1
Insulation Resistance(min.)	5000MΩ
Rated Voltage	100Vdc
Withstanding Voltage	250Vdc
Capacitance	100pF
Capacitance Tolerance	±20%
Structure/Shape	Small type beads inside (straight)

Attention

- 1.This datasheet is downloaded from the website of Murata Manufacturing Co., Ltd. Therefore, it's specifications are subject to change or our products in it may be discontinued without advance notice. Please check with our sales representatives or product engineers before ordering.
- 2.This datasheet has only typical specifications because there is no space for detailed specifications. Therefore, please review our product specifications or consult the approval sheet for product specifications before ordering.

DSS6NC52A101Q55#

“#” indicates a package specification code.

Product Data

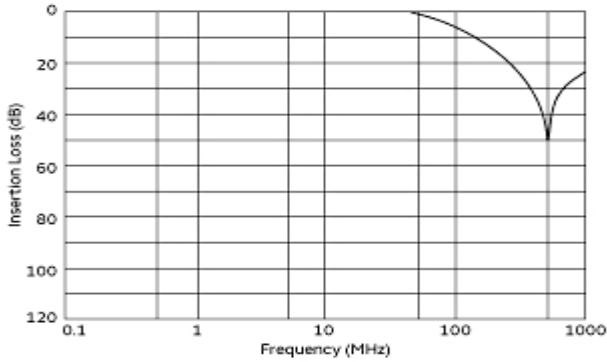

Insertion Loss Characteristics

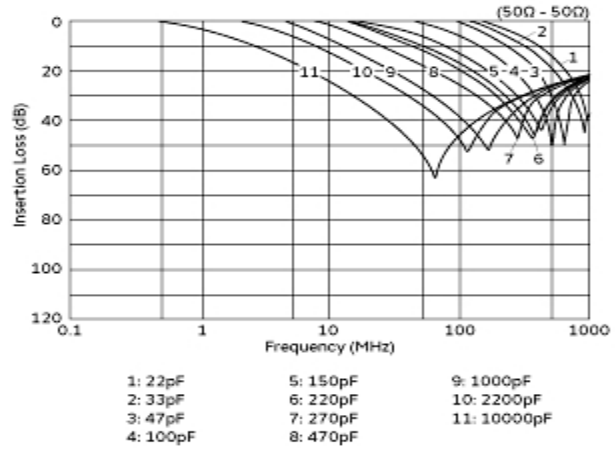

Insertion Loss Characteristics (Main Items)

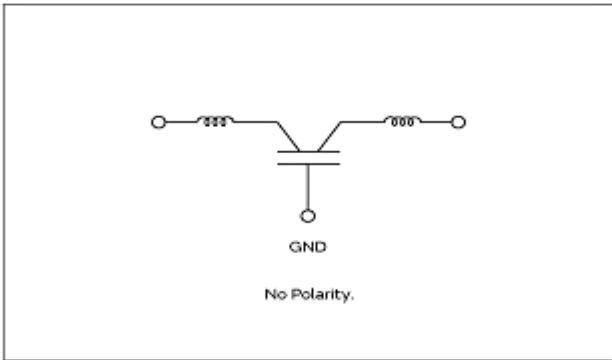

Equivalent Circuit

Attention

- 1.This datasheet is downloaded from the website of Murata Manufacturing Co., Ltd. Therefore, it's specifications are subject to change or our products in it may be discontinued without advance notice. Please check with our sales representatives or product engineers before ordering.
- 2.This datasheet has only typical specifications because there is no space for detailed specifications.
Therefore, please review our product specifications or consult the approval sheet for product specifications before ordering.