

3-terminal Filters

For Signal Line

MEM series

Type:	MEM2012S	2012[0805 inch]*
	MEM2012SC	2012[0805 inch]
	MEM2012V	2012[0805 inch]
	MEM2012F	2012[0805 inch]
	MEM1608P	1608[0603 inch]

* Dimensions Code JIS[EIA]

Issue date: February 2013

- All specifications are subject to change without notice.
- Conformity to RoHS Directive: This means that, in conformity with EU Directive 2002/95/EC, lead, cadmium, mercury, hexavalent chromium, and specific bromine-based flame retardants, PBB and PBDE, have not been used, except for exempted applications.

3-terminal Filters For Signal Line

Conformity to RoHS Directive

MEM Series MEM2012S

FEATURES

- Multilayer chip EMC filter utilizing a T-type circuit.
- Entirely monolithic structure results in high reliability.
- Due to closed magnetic circuit architecture, high-density installation becomes possible, and crosstalk generation is prevented.
- Steep attenuation characteristic plot. Highly effective noise suppression.
- Covers a wide range of frequencies.
- MEM2012S is a coil type EMC filter.
- This product is low profile type with the height of 0.85mm.

APPLICATIONS

Computer and computer peripherals, VCRs, TVs, car audio equipment, printers, game machines, etc.

TEMPERATURE RANGE

Operating	-40 to +85°C
Storage(After mount)	-40 to +85°C

PACKAGING STYLE AND QUANTITIES

Packaging style	Quantity
Taping	4000 pieces / reel

PRODUCT IDENTIFICATION

MEM	2012	S	25R0	T	□□□
(1)	(2)	(3)	(4)	(5)	(6)

- (1) Series name
- (2) Dimensions L×W
- (3) Type name
- (4) Cutoff frequency 25R0: 25MHz
- (5) Packaging style T:Taping
- (6) TDK internal code

RECOMMENDED SOLDERING CONDITION REFLOW SOLDERING

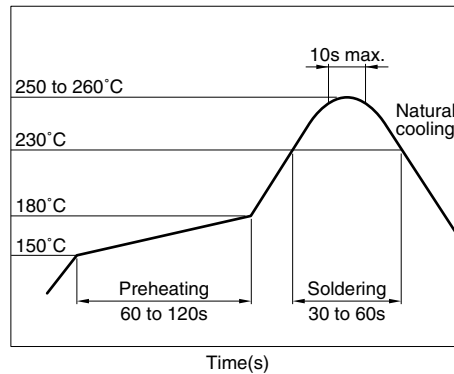

SHAPES AND DIMENSIONS/RECOMMENDED PC BOARD PATTERN

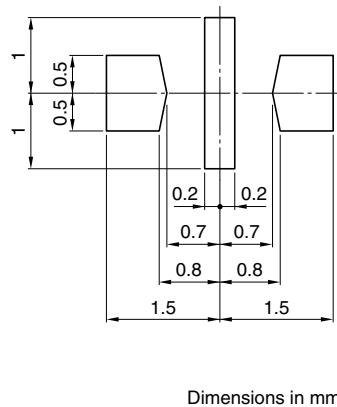
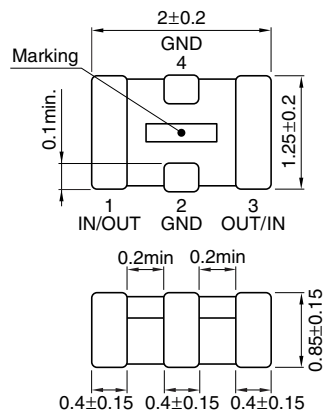

- Conformity to RoHS Directive: This means that, in conformity with EU Directive 2002/95/EC, lead, cadmium, mercury, hexavalent chromium, and specific bromine-based flame retardants, PBB and PBDE, have not been used, except for exempted applications.
- Please contact our Sales office when your application is considered the following:
The device's failure or malfunction may directly endanger human life (e.g. application for automobile/aircraft/medical/nuclear power devices, etc.)
- All specifications are subject to change without notice.

ELECTRICAL CHARACTERISTICS

Part No.	Cutoff frequency (MHz)	Insertion loss (dB)min.	Rated voltage Edc(V)max.	Rated current (mA)max.
MEM2012S25R0T	25	30[70MHz to 2GHz]	10	100
MEM2012S35R0T	35	30[90MHz to 2GHz]	10	100
MEM2012S50R0T	50	30[200MHz to 2GHz]	10	100
MEM2012S101RT	100	30[400MHz to 2GHz]	10	250
MEM2012S201RT	200	30[530MHz to 2.5GHz]	10	250

TYPICAL ELECTRICAL CHARACTERISTICS

ATTENUATION vs. FREQUENCY CHARACTERISTICS

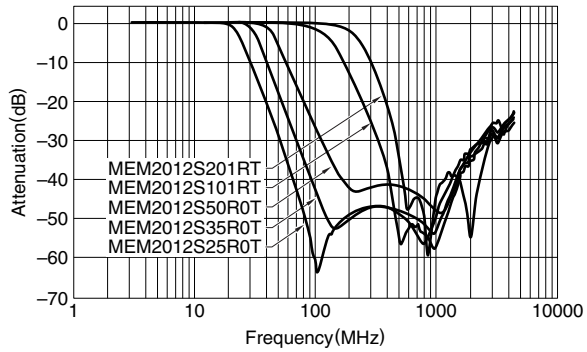

MEASURING CIRCUIT

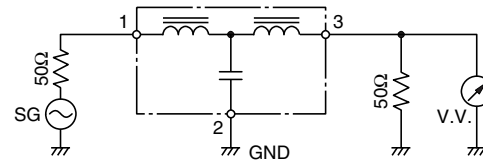

3-terminal Filters For Signal Line

Conformity to RoHS Directive

MEM Series MEM2012SC

FEATURES

- Multilayer chip EMC filter utilizing a T-type circuit.
- Entirely monolithic structure results in high reliability.
- Due to closed magnetic circuit architecture, high-density installation becomes possible, and crosstalk generation is prevented.
- Steep attenuation characteristic plot. Highly effective noise suppression.
- Covers a wide range of frequencies.
- MEM2012SC combines a bead inductor with a through-type capacitor.

APPLICATIONS

Computer and computer peripherals, VCRs, TVs, car audio equipment, printers, game machines, etc.

TEMPERATURE RANGE

Operating	-40 to +85°C
Storage(After mount)	-40 to +85°C

PACKAGING STYLE AND QUANTITIES

Packaging style	Quantity
Taping	4000 pieces / reel

PRODUCT IDENTIFICATION

MEM	2012	S	C100	T	□□□
(1)	(2)	(3)	(4)	(5)	(6)

- (1) Series name
- (2) Dimensions L×W
- (3) Type name
- (4) Capacitance C100: 10pF at 1MHz
- (5) Packaging style T:Taping
- (6) TDK internal code

RECOMMENDED SOLDERING CONDITION REFLOW SOLDERING

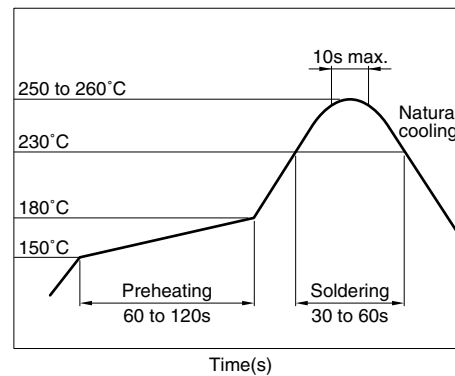

SHAPES AND DIMENSIONS/RECOMMENDED PC BOARD PATTERN

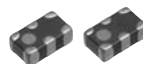
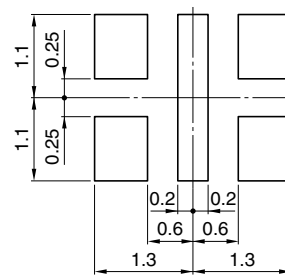
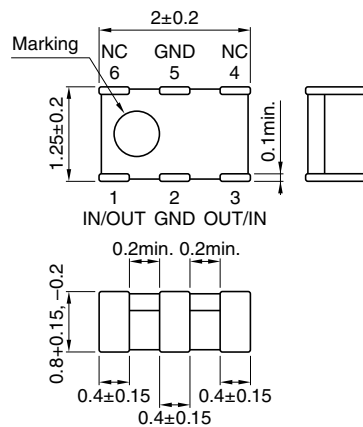

Dimensions in mm

- Conformity to RoHS Directive: This means that, in conformity with EU Directive 2002/95/EC, lead, cadmium, mercury, hexavalent chromium, and specific bromine-based flame retardants, PBB and PBDE, have not been used, except for exempted applications.
- Please contact our Sales office when your application is considered the following:
The device's failure or malfunction may directly endanger human life (e.g. application for automobile/aircraft/medical/nuclear power devices, etc.)
- All specifications are subject to change without notice.

ELECTRICAL CHARACTERISTICS

Part No.	Capacitance* (pF)	Tolerance (%)	Rated voltage Edc(V)max.	Rated current Idc(A)max.	DC resistance (Ω) max. [Terminal No.1 to 3]
MEM2012SC100	10	± 30	12	1	0.12
MEM2012SC220	22	± 30	12	1	0.12
MEM2012SC470	47	± 30	12	1	0.12
MEM2012SC101	100	± 30	12	1	0.12
MEM2012SC151	150	± 30	12	1	0.12

*Measuring frequency: 1(MHz), measuring voltage: 1(V)

TYPICAL ELECTRICAL CHARACTERISTICS

ATTENUATION vs. FREQUENCY CHARACTERISTICS

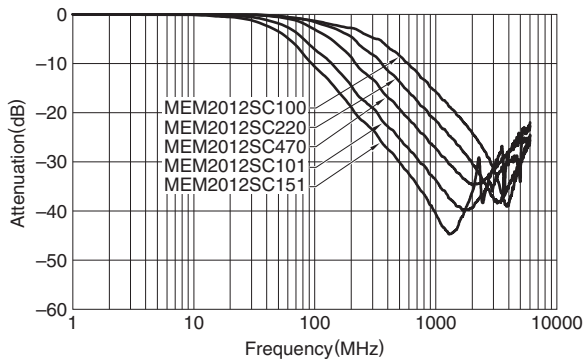

MEASURING CIRCUIT

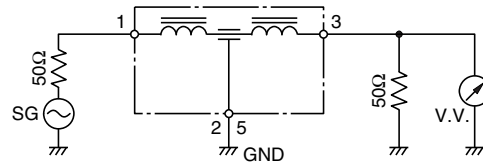

3-terminal Filters For Signal Line

Conformity to RoHS Directive

MEM Series MEM2012V

These SMD Type 3-terminal filters are used for elimination of high frequency noise from signal lines. Due to a higher cutoff frequency than earlier SMD type 3-terminal filters and steep attenuation characteristics, these filters are effective for elimination of a high level of high frequency noise.

FEATURES

- Steeper and wider bandwidth attenuation characteristics than earlier type.
- Used for high cutoff frequency applications.
- This product is low profile type with the height of 0.85mm.
- Entirely monolithic architecture.

APPLICATIONS

Signal line noise elimination for PCs, liquid crystal panels, printers, game machines, cellular phones, DVCs, etc.

TEMPERATURE RANGE

Operating	-40 to +85°C
Storage(After mount)	-40 to +85°C

PACKAGING STYLE AND QUANTITIES

Packaging style	Quantity
Taping	4000 pieces / reel

PRODUCT IDENTIFICATION

MEM	2012	V	121R	T	□□□
(1)	(2)	(3)	(4)	(5)	(6)

- (1) Series name
- (2) Dimensions L×W
- (3) Type name
- (4) Cutoff frequency 121R: 120MHz
- (5) Packaging style T:Taping
- (6) TDK internal code

RECOMMENDED SOLDERING CONDITION REFLOW SOLDERING

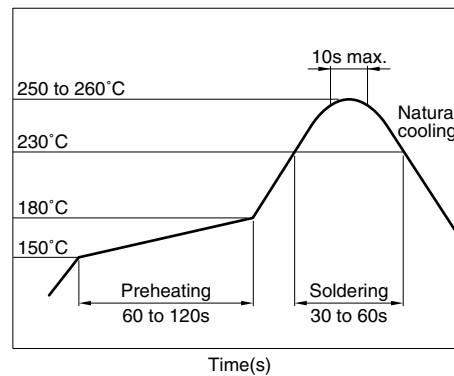

SHAPES AND DIMENSIONS/RECOMMENDED PC BOARD PATTERN

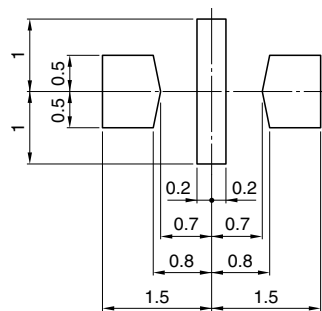
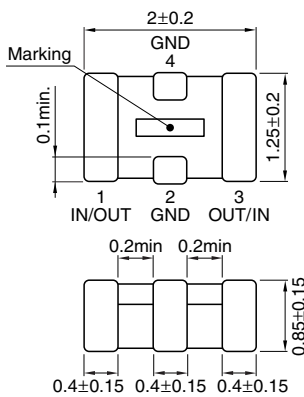

Dimensions in mm



- Conformity to RoHS Directive: This means that, in conformity with EU Directive 2002/95/EC, lead, cadmium, mercury, hexavalent chromium, and specific bromine-based flame retardants, PBB and PBDE, have not been used, except for exempted applications.
- Please contact our Sales office when your application is considered the following:
The device's failure or malfunction may directly endanger human life (e.g. application for automobile/aircraft/medical/nuclear power devices, etc.)
- All specifications are subject to change without notice.

ELECTRICAL CHARACTERISTICS

Part No.	Cutoff frequency (MHz)	Insertion loss (dB)min.	Rated voltage Edc(V)max.	Rated current (mA)max.
MEM2012V121RT	120	20 [200MHz to 2GHz]	10	100
MEM2012V151RT	150	20 [250MHz to 2GHz]	10	100
MEM2012V181RT	180	20 [300MHz to 2GHz]	10	100
MEM2012V211RT	210	20 [350MHz to 2GHz]	10	100
MEM2012V241RT	240	20 [450MHz to 2GHz]	10	100
MEM2012V301RT	300	20 [550MHz to 2GHz]	10	100

TYPICAL ELECTRICAL CHARACTERISTICS

ATTENUATION vs. FREQUENCY CHARACTERISTICS

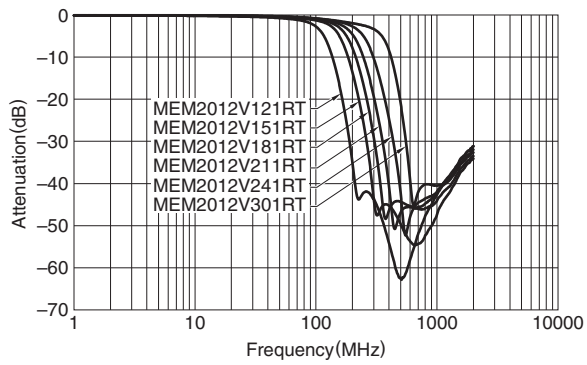

MEASURING CIRCUIT

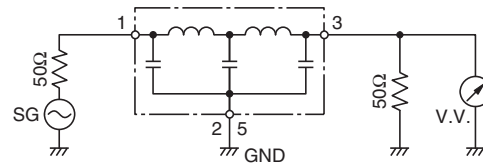

3-terminal Filters For Signal Line

Conformity to RoHS Directive

MEM Series MEM2012F

FEATURES

- Multilayer chip EMC filter that is small and low-profile due to the use of a π -type circuit.
- Entirely monolithic structure results in high reliability.
- Due to closed magnetic circuit architecture, high-density installation becomes possible, and crosstalk generation is prevented.
- Steep attenuation characteristic plot. Highly effective noise suppression.
- Covers a wide range of frequencies.
- π -type circuit with 1 coil / 2 capacitors construction.

APPLICATIONS

Computers, computer peripherals, VCRs, TVs, car audio equipment, printers, game machines, etc.

TEMPERATURE RANGE

Operating	-40 to +85°C
Storage(After mount)	-40 to +85°C

PACKAGING STYLE AND QUANTITIES

Packaging style	Quantity
Taping	4000 pieces / reel

PRODUCT IDENTIFICATION

MEM	2012	F	25R0	T	□□□
(1)	(2)	(3)	(4)	(5)	(6)

- (1) Series name
- (2) Dimensions L×W
- (3) Type name
- (4) Cutoff frequency 25R0: 25MHz
- (5) Packaging style T:Taping
- (6) TDK internal code

RECOMMENDED SOLDERING CONDITION REFLOW SOLDERING

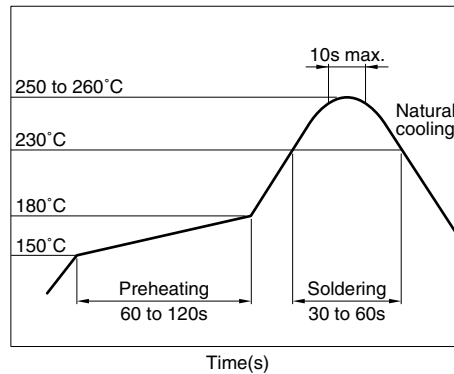

SHAPES AND DIMENSIONS/RECOMMENDED PC BOARD PATTERN

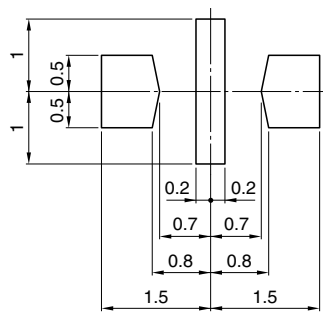
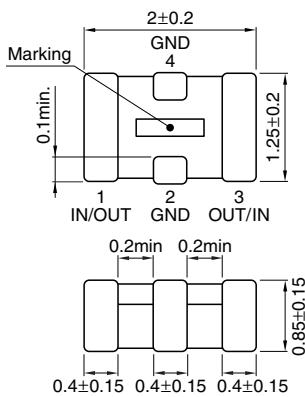

Dimensions in mm



- Conformity to RoHS Directive: This means that, in conformity with EU Directive 2002/95/EC, lead, cadmium, mercury, hexavalent chromium, and specific bromine-based flame retardants, PBB and PBDE, have not been used, except for exempted applications.
- Please contact our Sales office when your application is considered the following:
The device's failure or malfunction may directly endanger human life (e.g. application for automobile/aircraft/medical/nuclear power devices, etc.)
- All specifications are subject to change without notice.

ELECTRICAL CHARACTERISTICS

Part No.	Cutoff frequency (MHz)	Insertion loss (dB)min.	Rated voltage Edc(V)max.	Rated current (mA)max.
MEM2012F10R0T	10	20 [200MHz to 2GHz]	12	200
MEM2012F25R0T	25	20 [300MHz to 2GHz]	12	200
MEM2012F50R0T	50	20 [400MHz to 2GHz]	12	200
MEM2012F75R0T	75	20 [700MHz to 2GHz]	12	200
MEM2012F101RT	100	20 [1.5GHz to 2GHz]	12	200

TYPICAL ELECTRICAL CHARACTERISTICS

ATTENUATION vs. FREQUENCY CHARACTERISTICS

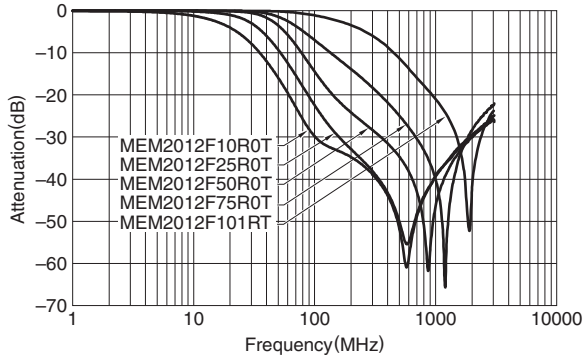

MEASURING CIRCUIT

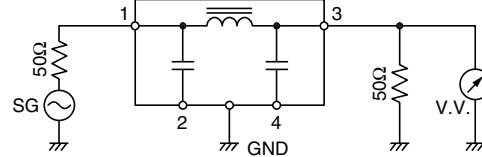

3-terminal Filters For Signal Line

Conformity to RoHS Directive

MEM Series MEM1608P

FEATURES

- Multilayer chip EMC filter utilizing a π -type circuit.
- Entirely monolithic structure results in high reliability.
- Due to closed magnetic circuit architecture, high-density installation becomes possible, and crosstalk generation is prevented.
- Steep attenuation characteristic plot. Highly effective noise suppression.
- Covers a wide range of frequencies.
- MEM1608P is a coil type EMC filter.
- This product is low profile type with the height of 0.6mm.

APPLICATIONS

Computer and computer peripherals, VCRs, TVs, car audio equipment, printers, game machines, etc.

TEMPERATURE RANGE

Operating	-40 to +85°C
Storage(After mount)	-40 to +85°C

PACKAGING STYLE AND QUANTITIES

Packaging style	Quantity
Taping	4000 pieces/reel

PRODUCT IDENTIFICATION

MEM	1608	P	25R0	T	<input type="checkbox"/>	<input type="checkbox"/>	<input type="checkbox"/>
(1)	(2)	(3)	(4)	(5)	(6)		

- (1) Series name
- (2) Dimensions L×W
- (3) Type name
- (4) Cutoff frequency 25R0: 25MHz
- (5) Packaging style T:Taping
- (6) TDK internal code

RECOMMENDED SOLDERING CONDITION REFLOW SOLDERING

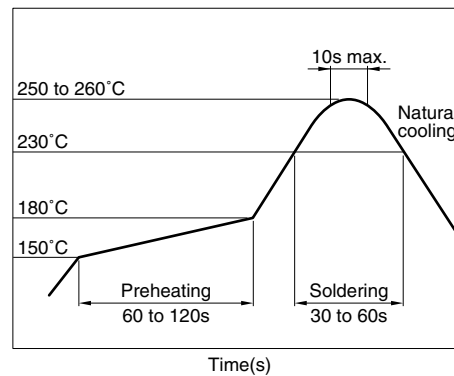

SHAPES AND DIMENSIONS/CIRCUIT DIAGRAM/RECOMMENDED PC BOARD PATTERN

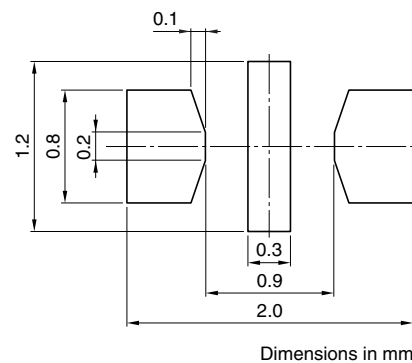
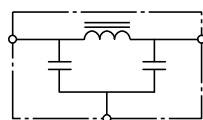
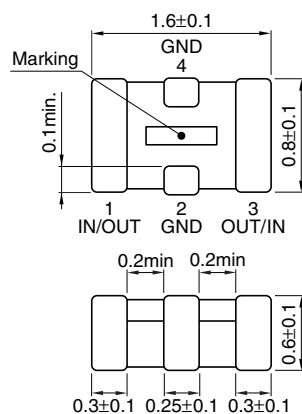

- Conformity to RoHS Directive: This means that, in conformity with EU Directive 2002/95/EC, lead, cadmium, mercury, hexavalent chromium, and specific bromine-based flame retardants, PBB and PBDE, have not been used, except for exempted applications.
- Please contact our Sales office when your application is considered the following:
The device's failure or malfunction may directly endanger human life (e.g. application for automobile/aircraft/medical/nuclear power devices, etc.)
- All specifications are subject to change without notice.

ELECTRICAL CHARACTERISTICS

Part No.	Cutoff frequency (MHz)	Insertion loss (dB)min.	Rated voltage Edc(V)max.	Rated current (mA)max.
MEM1608P25R0	25	20[70MHz to 2GHz]	10	100
MEM1608P35R0	35	20[90MHz to 2GHz]	10	100
MEM1608P50R0	50	20[200MHz to 2GHz]	10	100
MEM1608P75R0	75	20[300MHz to 2GHz]	10	100
MEM1608P101R	100	20[400MHz to 2GHz]	10	100

TYPICAL ELECTRICAL CHARACTERISTICS

ATTENUATION vs. FREQUENCY CHARACTERISTICS

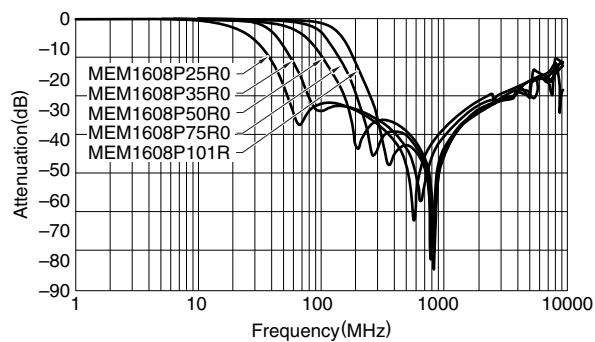

MEASURING CIRCUIT

