

△Note • Please read rating and △CAUTION (for storage, operating, rating, soldering, mounting and handling) in this catalog to prevent smoking and/or burning, etc.
• This catalog has only typical specifications because there is no space for detailed specifications. Therefore, please review our product specifications or consult the approval sheet for product specifications before ordering.

R03E.pdf
Jun.3.2011

NTC/PTC Thermistors for Automotive

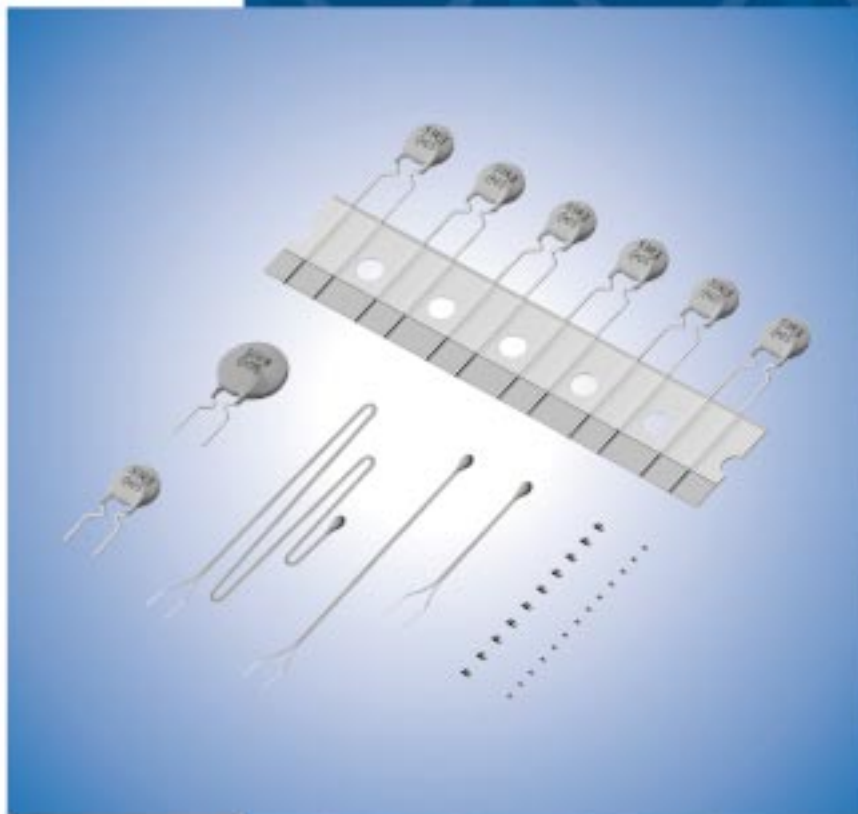

Cat.No.R03E-6

muRata

*Innovator
in Electronics*

Murata
Manufacturing Co., Ltd.

⚠Note • Please read rating and ⚠CAUTION (for storage, operating, rating, soldering, mounting and handling) in this catalog to prevent smoking and/or burning, etc.
• This catalog has only typical specifications because there is no space for detailed specifications. Therefore, please review our product specifications or consult the approval sheet for product specifications before ordering.

R03E.pdf
Jun.3,2011

EU RoHS Compliant

- All the products in this catalog comply with EU RoHS.
- EU RoHS is "the European Directive 2002/95/EC on the Restriction of the Use of Certain Hazardous Substances in Electrical and Electronic Equipment."
- For more details, please refer to our website 'Murata's Approach for EU RoHS' (<http://www.murata.com/info/rohs.html>).



CONTENTS

POSISTOR® and "POSISTOR" in this catalog are the trademarks of Murata Manufacturing Co., Ltd.

CONTENTS	2	1
Part Numbering	2	
Basic Characteristics of NTC Thermistor	6	2
Basic Characteristics of POSISTOR®	7	
1 NTC Thermistor Chip Type 0402 (1005) Size (Meet AEC-Q200rev.C)	8	
2 NTC Thermistor Chip Type 0603 (1608) Size (Meet AEC-Q200rev.C)	10	3
3 NTC Thermistor Chip Type 0603 (1608) Size for Conductive Glue	12	
NTC Thermistors Chip Type Standard Land Pattern Dimensions	13	
NTC Thermistors Chip Type Temperature Characteristics (Center Value)	14	
NTC Thermistors Chip Type Specifications and Test Methods	21	4
NTC Thermistors Chip Type △Caution/Notice	24	
4 NTC Thermistor Thermo String Type for Temperature Sensor	28	
● NTC Thermistors Thermo String Type Temperature Characteristics (Center Value)	29	5
● NTC Thermistors Thermo String Type Specifications and Test Methods	30	
● NTC Thermistors Thermo String Type △Caution/Notice	32	
5 PTC Thermistor (POSISTOR®) for Overheat Sensing Chip Type 0603 (1608) Size	33	6
● Chip Type of POSISTOR® for Overheat Sensing Specifications and Test Methods	38	
6 PTC Thermistor (POSISTOR®) for Overcurrent Protection Chip Type 0805 (2012) Size	40	
● Chip Type of POSISTOR® for Overcurrent Protection Specifications and Test Methods	42	
POSISTOR® Chip Type △Caution/Notice	46	7
7 PTC Thermistor (POSISTOR®) for Overcurrent Protection Lead Type	54	
● POSISTOR® Lead Type for Overcurrent Protection Specifications and Test Methods	64	
● POSISTOR® Lead Type for Overcurrent Protection △Caution/Notice	67	
NTC Thermistors Chip Type/Thermo String Type Package	68	
POSISTOR® Chip Type Package	70	
POSISTOR® Lead Type Package	71	

● Part Numbering

NTC Thermistors for Temperature Compensation Chip Type

(Part Number)

NC	P	18	XH	103	J	0S	RB
①	②	③	④	⑤	⑥	⑦	⑧

① Product ID

Product ID	
NC	NTC Thermistors Chip Type

② Series

Code	Series
G	Conductive Glue Series
P	Plated Termination Series

③ Dimensions (L×W)

Code	Dimensions (L×W)	EIA
15	1.00×0.50mm	0402
18	1.60×0.80mm	0603

④ Temperature Characteristics

Code	Temperature Characteristics
WB	Nominal B-Constant 4050—4099K
WD	Nominal B-Constant 4150—4199K
WF	Nominal B-Constant 4250—4299K
WL	Nominal B-Constant 4450—4499K
WM	Nominal B-Constant 4500—4549K
XC	Nominal B-Constant 3100—3149K
XF	Nominal B-Constant 3250—3299K
XH	Nominal B-Constant 3350—3399K
XM	Nominal B-Constant 3500—3549K
XQ	Nominal B-Constant 3650—3699K
XV	Nominal B-Constant 3900—3949K
XW	Nominal B-Constant 3950—3999K

⑤ Resistance

Expressed by three figures. The unit is ohm (Ω). The first and second figures are significant digits, and the third figure expresses the number of zeros that follow the two figures.

Ex.)

Code	Resistance
102	1kΩ
103	10kΩ
104	100kΩ

⑥ Resistance Tolerance

Code	Resistance Tolerance
D	±0.5%
E	±3%
F	±1%
J	±5%

⑦ Individual Specifications

Structures and others are expressed by two figures.

Code	Individual Specifications
0S	for Automotive

⑧ Packaging

Code	Packaging
RB	Paper Taping 4mm Pitch (4000 pcs.)
RC	Paper Taping 2mm Pitch (10000 pcs.)

NTC Thermistor for Temperature Sensor Thermo String Type

(Part Number)

NXF	S	15	XH	103	F	A	2	B	025
①	②	③	④	⑤	⑥	⑦	⑧	⑨	⑩

① Product ID

Product ID	
NXF	NTC Thermistors Sensor Thermo String Type

② Individual Specifications

Code	Individual Specifications
S	for Automotive

③ Chip Dimensions

Code	Dimensions (LxT)	EIA
15	1.00 x 0.50mm	0402

④ Temperature Characteristics

Code	Temperature Characteristics
WB	Nominal B-Constant 4050–4099K
WF	Nominal B-Constant 4250–4299K
XH	Nominal B-Constant 3350–3399K

⑤ Resistance

Expressed by three figures. The unit is (Ω). The first and second figures are significant digits, and the third figure expresses the number of zeros that follow the two figures.

Ex.

Code	Resistance
103	10kΩ
473	47kΩ
104	100kΩ

⑥ Resistance Tolerance

Code	Resistance Tolerance
F	±1%

⑦ Lead Wire Type

Code	Lead Wire Type
A	ø0.3 Copper Lead Wire with Polyurethane Coat

⑧ Shape of the Lead Wire Kink

Code	Shape of the Lead Wire Kink
1	The Twist of Lead Wire Type
2	Standard Type

⑨ Packaging

Code	Packaging
B	Bulk

⑩ Dimensions (Full Length)

Code	Dimensions (Full Length)
025	25mm
030	30mm
040	40mm
050	50mm
060	60mm
070	70mm
080	80mm
090	90mm
100	100mm
110	110mm
120	120mm
130	130mm
140	140mm
150	150mm

PTC Thermistors (POSISTOR®) for Overheat Sensing Chip Type

(Part Number)

PR	F	18	BB	471	Q	S5	RB
①	②	③	④	⑤	⑥	⑦	⑧

① Product ID

Product ID	
PR	PTC Thermistors Chip Type

② Series

Code	Series
F	for Overheat Sensing

③ Dimensions (L×W)

Code	Dimensions (L×W)
18	1.60×0.80mm

④ Temperature Characteristics

Code	Temperature Characteristics-Curie Point
AR	120°C
AS	130°C
BA	110°C
BB	100°C
BC	90°C
BD	80°C
BE	70°C
BF	60°C
BG	50°C

⑤ Resistance

Expressed by three figures. The unit is ohm (Ω). The first and second figures are significant digits, and the third figure expresses the number of zeros that follow the two figures.

Ex.)

Code	Resistance
471	470Ω

⑥ Resistance Tolerance

Code	Resistance Tolerance	Sensing Temp. Tolerance
Q	Special Tolerance	±5°C
R	Special Tolerance	±3°C

⑦ Individual Specifications

Code	Individual Specifications
S2	for Automotive
S5	

⑧ Packaging

Code	Packaging
RB	Paper Taping (4mm Pitch) (4000 pcs.)

PTC Thermistors (POSISTOR®) for Overcurrent Protection Chip Type

(Part Number)

PR	G	21	AR	420	M	S1	RA
①	②	③	④	⑤	⑥	⑦	⑧

① Product ID

Product ID	
PR	PTC Thermistors Chip Type

② Series

Code	Series
G	for Overcurrent Protection

③ Dimensions (L×W)

Code	Dimensions (L×W)
21	2.00×1.25mm

④ Temperature Characteristics

Code	Temperature Characteristics
AR	Curie Point 120°C

⑤ Resistance

Expressed by three-digit alphanumerics. The unit is ohm (Ω). The first and second figures are significant digits, and the third figure expresses the number of zeros that follow the two figures. If there is a decimal point, it is expressed by the capital letter "R." In this case, all figures are significant digits.

Ex.)

Code	Resistance
4R7	4.7Ω
420	42Ω

⑥ Resistance Tolerance

Code	Resistance Tolerance
M	±20%
Q	Special Tolerance

⑦ Individual Specifications

Ex.)

Code	Individual Specifications
S1	for Automotive

⑧ Packaging

Code	Packaging
RA	Embossed Taping (4mm Pitch) (4000 pcs.)
RK	Embossed Taping (4mm Pitch) (3000 pcs.)

PTC Thermistors (POSISTOR®) for Overcurrent Protection Lead Type

(Part Number)

PT	GL	4	S	AS	220	K	4B51	B0
①	②	③	④	⑤	⑥	⑦	⑧	⑨

① Product ID

Product ID	
PT	PTC Thermistors

② Series

Code	Series
GL	for Overcurrent Protection Lead Type

③ Dimensions

Code	Dimensions
4	Nominal Body Diameter 4mm Series
5	Nominal Body Diameter 5mm Series
6	Nominal Body Diameter 6mm Series
7	Nominal Body Diameter 7mm Series
9	Nominal Body Diameter 9mm Series
A	Nominal Body Diameter 10mm Series
C	Nominal Body Diameter 12mm Series
E	Nominal Body Diameter 14mm Series

④ Individual Specifications

Code	Individual Specifications
S	for Automotive

⑤ Temperature Characteristics

Code	Temperature Characteristics
AR	Curie Point 120°C
AS	Curie Point 130°C

⑥ Resistance

Expressed by three-digit alphanumeric. The unit is ohm (Ω). The first and second figures are significant digits, and the third figure expresses the number of zeros that follow the two figures. If there is a decimal point, it is expressed by the capital letter "R." In this case, all figures are significant digits.

Ex.)

Code	Resistance
R22	0.22 Ω
2R2	2.2 Ω
220	22 Ω

⑦ Resistance Tolerance

Code	Resistance Tolerance
K	±10%
M	±20%

⑧ Individual Specifications

Ex.)

Code	Individual Specifications
4B51	Lead Type, others

⑨ Packaging

Code	Packaging
A0	Ammo Pack
B0	Bulk

Basic Characteristics of NTC Thermistor

Basic Characteristics

1. Zero-power Resistance of Thermistor: R

Measured by zero-power in specified ambient temperatures.

$$R = R_0 \exp B (1/T - 1/T_0) \quad \dots\dots\dots(1)$$

R: Resistance in ambient temperature T (K)
 (K: absolute temperature)

R₀: Resistance in ambient temperature T₀ (K)

B: B-constant of Thermistor

2. B-Constant

as (1) formula

$$B = \ln (R/R_0) / (1/T - 1/T_0) \quad \dots\dots\dots(2)$$

3. Thermal Dissipation Constant

When electric power P (mW) is spent in ambient temperature T₁ and thermistor temperature rises T₂, the formula is as follows;

$$P = C (T_2 - T_1) \quad \dots\dots\dots(3)$$

C: Thermal dissipation constant (mW/°C)

Thermal dissipation constant varies with dimensions, measurement conditions, etc.

4. Thermal Time Constant

Period in which Thermistor's temperature will change 63.2% of its temperature difference from ambient temperature T₀ (°C) to T₁ (°C).

5. Rated Electric Power

Shows necessary electric power for Thermistor's temperature to rise 100°C by self heating in ambient temperature 25°C.

6. Permissive Operating Current

It is possible to keep Thermistor's temperature rising max. 1°C.

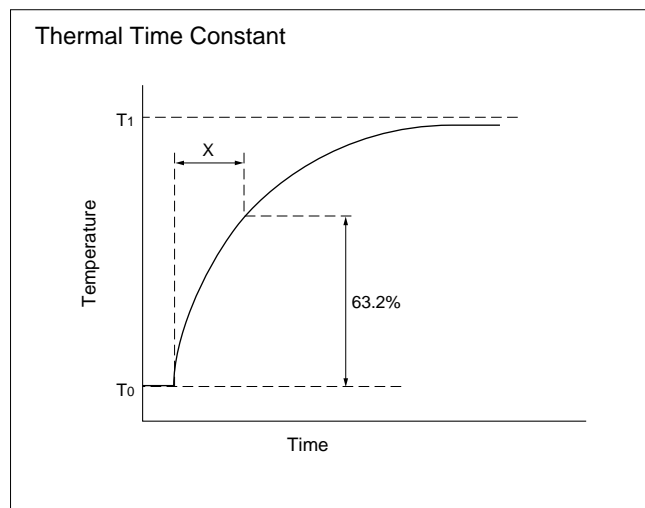
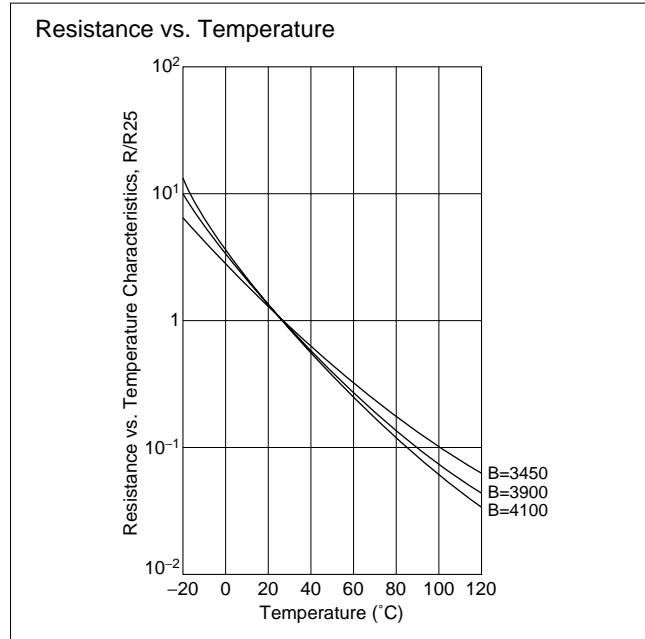

Basic Characteristics of POSISTOR®

Basic Characteristics

POSISTOR® has three main characteristics.

1. Resistance - Temperature Characteristics

Although there is a negligible difference between the normal and "Curie Point" temperature, POSISTOR® shows almost constant resistance - temperature characteristics. Yet they have resistance - temperature characteristics that cause resistance to sharply increase when the temperature exceeds the Curie Point. The Curie Point (C.P.) is defined as the temperature at which the resistance value is twice the one at 25 °C.

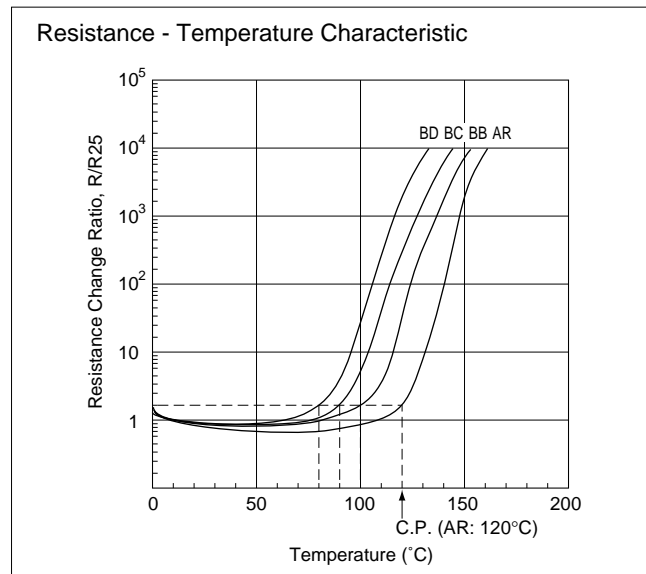

2. Current - Voltage Characteristics (Static Characteristics)

This shows the relation between applied voltage when voltage applied to POSISTOR® causes balancing of inner heating and outer thermal dissipation and stabilized current. This has both a maximum point of current and constant output power.

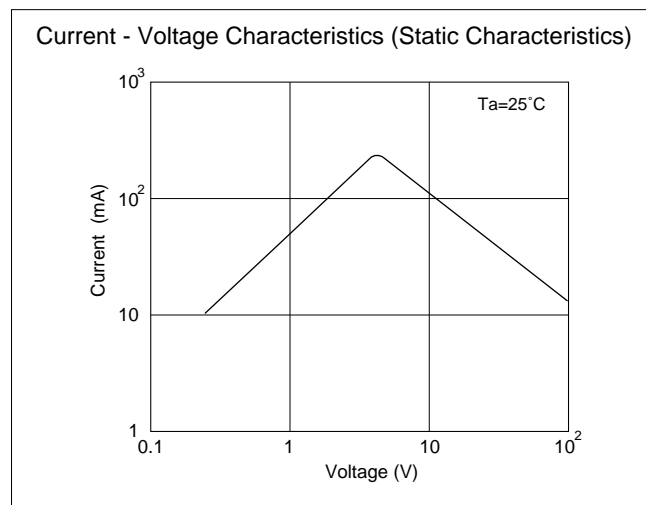

3. Current - Time Characteristics (Dynamic Characteristics)

This shows the relation between current and time before inner heating and outer thermal dissipation arrive at equilibrium state. This features having large initial current and abruptly continuous attenuating portion.

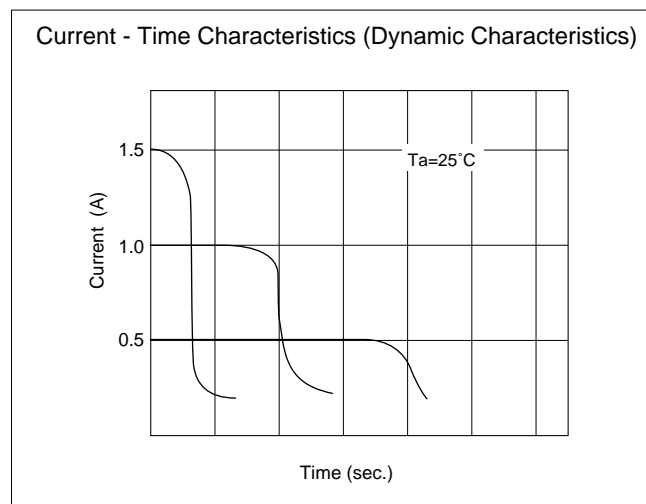

1

NTC/PTC Thermistors for Automotive



NTC Thermistor Chip Type 0402 (1005) Size (Meet AEC-Q200rev.C)

0402/0603 sized Chip NTC Thermistors have Ni barrier termination, provide excellent solderability and offer high stability in environment due to unique inner construction.

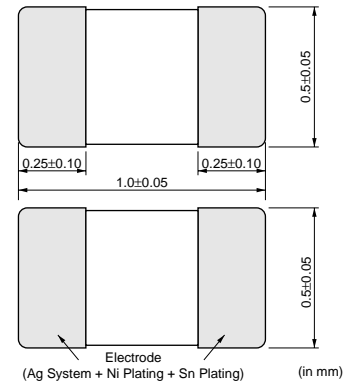

■ Features

1. Excellent solderability and high stability in environment
2. Excellent long time aging stability
3. High accuracy in resistance and B-constant
4. Reflow soldering possible
5. Lead is not contained in the product
6. NCP series are recognized by UL/cUL.
(UL1434, File No.E137188)

■ Applications

1. Car audio, car navigation
2. Various engine control units
3. Circuits for ETC equipment
4. Various motor driving circuits
5. Temperature compensation for various circuits

Operating Temperature Range: -40°C to +150°C

Part Number	Resistance (25°C) (ohm)	B-Constant (25-50°C) (K)	B-Constant (25-80°C) (Reference Value) (K)	B-Constant (25-85°C) (Reference Value) (K)	B-Constant (25-100°C) (Reference Value) (K)	Permissible Operating Current (25°C) (mA)	Rated Electric Power (25°C) (mW)	Typical Dissipation Constant (25°C) (mW/°C)
NCP15XW152□0SRC	1.5k	3950 ±3%	3982	3987	3998	0.81	100	1
NCP15XW222□0SRC	2.2k	3950 ±3%	3982	3987	3998	0.67	100	1
NCP15XW332□0SRC	3.3k	3950 ±3%	3982	3987	3998	0.55	100	1
NCP15XW472□0SRC	4.7k	3950 ±3%	3982	3987	3998	0.46	100	1
NCP15XW682□0SRC	6.8k	3950 ±3%	3982	3987	3998	0.38	100	1
NCP15XH103D0SRC	10k ±0.5%	3380 ±0.7%	3428	3434	3455	0.31	100	1
NCP15XH103F0SRC	10k ±1%	3380 ±1%	3428	3434	3455	0.31	100	1
NCP15XH103□0SRC	10k	3380 ±1%	3428	3434	3455	0.31	100	1
NCP15XV103□0SRC	10k	3900 ±3%	3930	3934	3944	0.31	100	1
NCP15XW153□0SRC	15k	3950 ±3%	3982	3987	3998	0.25	100	1
NCP15XW223□0SRC	22k	3950 ±3%	3982	3987	3998	0.21	100	1
NCP15WL223□0SRC	22k	4485 ±1%	4537	4543	4557	0.21	100	1
NCP15WB333□0SRC	33k	4050 ±3%	4101	4108	4131	0.17	100	1
NCP15WL333□0SRC	33k	4485 ±1%	4537	4543	4557	0.17	100	1
NCP15WB473D0SRC	47k ±0.5%	4050 ±0.5%	4101	4108	4131	0.14	100	1
NCP15WB473F0SRC	47k ±1%	4050 ±1%	4101	4108	4131	0.14	100	1
NCP15WB473□0SRC	47k	4050 ±1%	4101	4108	4131	0.14	100	1
NCP15WL473□0SRC	47k	4485 ±1%	4537	4543	4557	0.14	100	1
NCP15WD683□0SRC	68k	4150 ±3%	4201	4209	4232	0.12	100	1
NCP15WL683□0SRC	68k	4485 ±1%	4537	4543	4557	0.12	100	1
NCP15WF104D0SRC	100k ±0.5%	4250 ±0.5%	4303	4311	4334	0.10	100	1
NCP15WF104F0SRC	100k ±1%	4250 ±1%	4303	4311	4334	0.10	100	1
NCP15WF104□0SRC	100k	4250 ±1%	4303	4311	4334	0.10	100	1
NCP15WL104□0SRC	100k	4485 ±1%	4537	4543	4557	0.10	100	1
NCP15WL154□0SRC	150k	4485 ±1%	4537	4543	4557	0.08	100	1
NCP15WM154□0SRC	150k	4500 ±3%	4571	4582	4614	0.08	100	1

Continued on the following page.



△Note • Please read rating and △CAUTION (for storage, operating, rating, soldering, mounting and handling) in this catalog to prevent smoking and/or burning, etc.
 • This catalog has only typical specifications because there is no space for detailed specifications. Therefore, please review our product specifications or consult the approval sheet for product specifications before ordering.

Continued from the preceding page.

Part Number	Resistance (25°C) (ohm)	B-Constant (25-50°C) (K)	B-Constant (25-80°C) (Reference Value) (K)	B-Constant (25-85°C) (Reference Value) (K)	B-Constant (25-100°C) (Reference Value) (K)	Permissible Operating Current (25°C) (mA)	Rated Electric Power (25°C) (mW)	Typical Dissipation Constant (25°C) (mW/°C)
NCP15WM224□0SRC	220k	4500 ±3%	4571	4582	4614	0.06	100	1
NCP15WM474□0SRC	470k	4500 ±3%	4571	4582	4614	0.04	100	1

1

A blank column is filled with resistance tolerance codes (E: ±3%, J: ±5%).
 Rated Electric Power is necessary electric power for Thermistor's temperature to rise 100°C by self heating at 25°C in still air.

Operating Temperature Range: -40°C to +125°C

Part Number	Resistance (25°C) (ohm)	B-Constant (25-50°C) (K)	B-Constant (25-80°C) (Reference Value) (K)	B-Constant (25-85°C) (Reference Value) (K)	B-Constant (25-100°C) (Reference Value) (K)	Permissible Operating Current (25°C) (mA)	Rated Electric Power (25°C) (mW)	Typical Dissipation Constant (25°C) (mW/°C)
NCP15XC220□0SRC	22	3100 ±3%	3126	3128	3136	6.70	100	1
NCP15XC330□0SRC	33	3100 ±3%	3126	3128	3136	5.50	100	1
NCP15XC470□0SRC	47	3100 ±3%	3126	3128	3136	4.60	100	1
NCP15XC680□0SRC	68	3100 ±3%	3126	3128	3136	3.80	100	1
NCP15XF101□0SRC	100	3250 ±3%	3282	3284	3296	3.10	100	1
NCP15XF151□0SRC	150	3250 ±3%	3282	3284	3296	2.50	100	1
NCP15XM221□0SRC	220	3500 ±3%	3539	3545	3560	2.10	100	1
NCP15XM331□0SRC	330	3500 ±3%	3539	3545	3560	1.70	100	1
NCP15XQ471□0SRC	470	3650 ±2%	3688	3693	3706	1.40	100	1
NCP15XQ681□0SRC	680	3650 ±3%	3688	3693	3706	1.20	100	1
NCP15XQ102□0SRC	1.0k	3650 ±2%	3688	3693	3706	1.00	100	1
NCP15XM472□0SRC	4.7k	3500 ±2%	3539	3545	3560	0.46	100	1

A blank column is filled with resistance tolerance codes (E: ±3%, J: ±5%).
 Rated Electric Power is necessary electric power for Thermistor's temperature to rise 100°C by self heating at 25°C in still air.

NTC/PTC Thermistors for Automotive



NTC Thermistor Chip Type 0603 (1608) Size (Meet AEC-Q200rev.C)

2

0402/0603 sized Chip NTC Thermistors have Ni barrier termination, provide excellent solderability and offer high stability in environment due to unique inner construction.

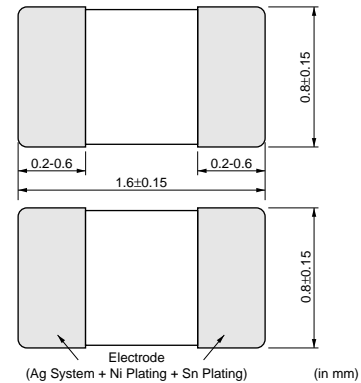

■ Features

1. Excellent solderability and high stability in environment
2. Excellent long time aging stability
3. High accuracy in resistance and B-constant
4. Flow/Reflow soldering possible
5. Lead is not contained in the product
6. NCP series are recognized by UL/cUL.
(UL1434, File No.E137188)

■ Applications

1. Car audio, car navigation
2. Various engine control units
3. Circuits for ETC equipment
4. Various motor driving circuits
5. Temperature compensation for various circuits

Operating Temperature Range: -40°C to +150°C

Part Number	Resistance (25°C) (ohm)	B-Constant (25-50°C) (K)	B-Constant (25-80°C) (Reference Value) (K)	B-Constant (25-85°C) (Reference Value) (K)	B-Constant (25-100°C) (Reference Value) (K)	Permissible Operating Current (25°C) (mA)	Rated Electric Power (25°C) (mW)	Typical Dissipation Constant (25°C) (mW/°C)
NCP18XF101□0SRB	100	3250 ±3%	3282	3284	3296	3.10	100	1
NCP18XF151□0SRB	150	3250 ±3%	3282	3284	3296	2.50	100	1
NCP18XQ471□0SRB	470	3650 ±2%	3688	3693	3706	1.40	100	1
NCP18XQ681□0SRB	680	3650 ±3%	3688	3693	3706	1.20	100	1
NCP18XQ102□0SRB	1.0k	3650 ±2%	3688	3693	3706	1.00	100	1
NCP18XW152□0SRB	1.5k	3950 ±3%	3982	3987	3998	0.81	100	1
NCP18XW222□0SRB	2.2k	3950 ±3%	3982	3987	3998	0.67	100	1
NCP18XW332□0SRB	3.3k	3950 ±3%	3982	3987	3998	0.55	100	1
NCP18XW472□0SRB	4.7k	3950 ±3%	3982	3987	3998	0.46	100	1
NCP18XW682□0SRB	6.8k	3950 ±3%	3982	3987	3998	0.38	100	1
NCP18XH103D0SRB	10k ±0.5%	3380 ±0.7%	3428	3434	3455	0.31	100	1
NCP18XH103F0SRB	10k ±1%	3380 ±1%	3428	3434	3455	0.31	100	1
NCP18XH103□0SRB	10k	3380 ±1%	3428	3434	3455	0.31	100	1
NCP18XV103□0SRB	10k	3900 ±3%	3930	3934	3944	0.31	100	1
NCP18XW153□0SRB	15k	3950 ±3%	3982	3987	3998	0.25	100	1
NCP18XW223□0SRB	22k	3950 ±3%	3982	3987	3998	0.21	100	1
NCP18WB333□0SRB	33k	4050 ±3%	4101	4108	4131	0.17	100	1
NCP18WB473D0SRB	47k ±0.5%	4030 ±0.5%	4101	4108	4131	0.14	100	1
NCP18WB473F1SRB	47k ±1%	4050 ±1.5%	4101	4108	4131	0.14	100	1
NCP18WB473□0SRB	47k	4050 ±2%	4101	4108	4131	0.14	100	1
NCP18WD683□0SRB	68k	4150 ±3%	4201	4209	4232	0.12	100	1
NCP18WF104D0SRB	100k ±0.5%	4200 ±0.5%	4255	4260	4282	0.10	100	1
NCP18WF104F3SRB	100k ±1%	4200 ±1%	4255	4260	4282	0.10	100	1
NCP18WF104□0SRB	100k	4250 ±2%	4303	4311	4334	0.10	100	1
NCP18WM154□0SRB	150k	4500 ±3%	4571	4582	4614	0.08	100	1
NCP18WM224□0SRB	220k	4500 ±3%	4571	4582	4614	0.06	100	1

Continued on the following page. ↗



⚠Note • Please read rating and ⚠CAUTION (for storage, operating, rating, soldering, mounting and handling) in this catalog to prevent smoking and/or burning, etc.
 • This catalog has only typical specifications because there is no space for detailed specifications. Therefore, please review our product specifications or consult the approval sheet for product specifications before ordering.

↳ Continued from the preceding page.

Part Number	Resistance (25°C) (ohm)	B-Constant (25-50°C) (K)	B-Constant (25-80°C) (Reference Value) (K)	B-Constant (25-85°C) (Reference Value) (K)	B-Constant (25-100°C) (Reference Value) (K)	Permissible Operating Current (25°C) (mA)	Rated Electric Power (25°C) (mW)	Typical Dissipation Constant (25°C) (mW/°C)
NCP18WM474□0SRB	470k	4500 ±3%	4571	4582	4614	0.04	100	1

A blank column is filled with resistance tolerance codes (E: ±3%, J: ±5%).

Rated Electric Power is necessary electric power for Thermistor's temperature to rise 100°C by self heating at 25°C in still air.

Operating Temperature Range: -40°C to +125°C

2

Part Number	Resistance (25°C) (ohm)	B-Constant (25-50°C) (K)	B-Constant (25-80°C) (Reference Value) (K)	B-Constant (25-85°C) (Reference Value) (K)	B-Constant (25-100°C) (Reference Value) (K)	Permissible Operating Current (25°C) (mA)	Rated Electric Power (25°C) (mW)	Typical Dissipation Constant (25°C) (mW/°C)
NCP18XM221□0SRB	220	3500 ±3%	3539	3545	3560	2.10	100	1
NCP18XM331□0SRB	330	3500 ±3%	3539	3545	3560	1.70	100	1
NCP18XM472□0SRB	4.7k	3500 ±2%	3539	3545	3560	0.46	100	1

A blank column is filled with resistance tolerance codes (E: ±3%, J: ±5%).

Rated Electric Power is necessary electric power for Thermistor's temperature to rise 100°C by self heating at 25°C in still air.

NTC/PTC Thermistors for Automotive



NTC Thermistor Chip Type 0603 (1608) Size for Conductive Glue

NCG18, 0603 sized Chip NTC Thermistor enables conductive glue mounting.

■ Features

1. Excellent solderability and high stability in environment
2. Excellent long time aging stability
3. High accuracy in resistance and B-constant
4. Glue mounting possible
5. Lead is not contained in the product

3

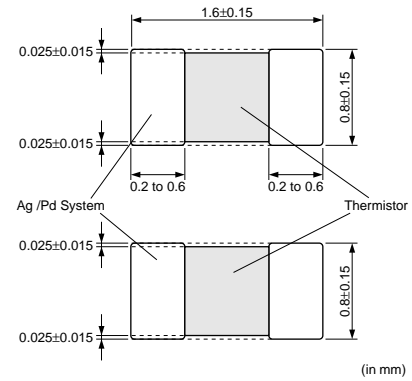

■ Applications

1. Various engine control units
2. ABS control unit
3. High power devices (IGBT)
4. Various circuits requiring low temperature mounting below solder melting point.
5. Temperature compensation for various circuits requiring high temperature.

Part Number	Resistance (25°C) (ohm)	B-Constant (25-50°C) (K)	B-Constant (25-80°C) (Reference Value) (K)	B-Constant (25-85°C) (Reference Value) (K)	B-Constant (25-100°C) (Reference Value) (K)	Permissible Operating Current (25°C) (mA)	Rated Electric Power (25°C) (mW)	Typical Dissipation Constant (25°C) (mW/°C)
NCG18XH103F0SRB	10k ±1%	3380 ±1%	3428	3434	3455	0.31	100	1
NCG18WF104F0SRB	100k ±1%	4200 ±1%	4255	4260	4282	0.10	100	1

Operating Temperature Range: -55°C to +150°C

Rated Electric Power is necessary electric power for Thermistor's temperature to rise 100°C by self heating at 25°C in still air.

△Note • Please read rating and △CAUTION (for storage, operating, rating, soldering, mounting and handling) in this catalog to prevent smoking and/or burning, etc.
 • This catalog has only typical specifications because there is no space for detailed specifications. Therefore, please review our product specifications or consult the approval sheet for product specifications before ordering.

R03E.pdf
 Jun.3,2011

NTC Thermistors Chip Type Standard Land Pattern Dimensions

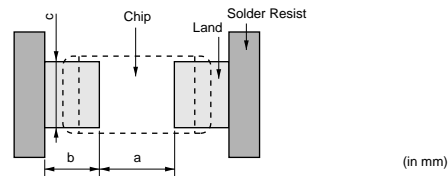

Part Number	Mounting Methods	Dimensions (mm)			
		Chip (L×W)	a	b	c
NCP15	Reflow Soldering	1.0×0.5	0.4	0.4-0.5	0.5
NCP18	Flow Soldering	1.6×0.8	0.6-1.0	0.8-0.9	0.6-0.8
	Reflow Soldering		0.6-0.8	0.6-0.7	0.6-0.8
NCG18	Conductive Glue	1.6×0.8	0.6	0.6	1.0

NTC Thermistors Chip Type Temperature Characteristics (Center Value)

■ Operating Temperature Range: -40°C to +150°C

Part Number	NCP18XF101	NCP18XF151	NCP18XQ471	NCP18XQ681	NCP18XQ102	NCP□□XW152	NCP□□XW222	NCP□□XW332
Resistance	100Ω	150Ω	470Ω	680Ω	1.0kΩ	1.5kΩ	2.2kΩ	3.3kΩ
B-Constant	3250K	3250K	3650K	3650K	3650K	3950K	3950K	3950K
Temp. (°C)	Resistance (Ω)	Resistance (Ω)	Resistance (Ω)	Resistance (Ω)	Resistance (kΩ)	Resistance (kΩ)	Resistance (kΩ)	Resistance (kΩ)
-40	1824.175	2736.262	11822.473	17104.854	25.154	51.791	75.961	113.941
-35	1390.685	2086.028	8767.745	12685.248	18.655	37.172	54.520	81.779
-30	1070.653	1605.979	6570.224	9505.855	13.979	27.005	39.607	59.411
-25	831.138	1246.708	4971.784	7193.219	10.578	19.843	29.103	43.654
-20	650.960	976.440	3796.933	5493.436	8.079	14.728	21.601	32.401
-15	514.441	771.661	2923.400	4229.599	6.220	11.044	16.198	24.297
-10	409.700	614.550	2269.599	3283.675	4.829	8.362	12.264	18.396
-5	328.877	493.315	1775.225	2568.411	3.777	6.389	9.370	14.055
0	265.759	398.639	1399.050	2024.158	2.977	4.922	7.219	10.829
5	215.785	323.677	1110.220	1606.275	2.362	3.825	5.609	8.414
10	176.395	264.592	887.257	1283.691	1.888	2.994	4.391	6.586
15	145.161	217.742	713.463	1032.245	1.518	2.361	3.463	5.195
20	120.152	180.228	577.375	835.351	1.229	1.876	2.751	4.126
25	100.000	150.000	470.000	680.000	1.000	1.500	2.200	3.300
30	83.669	125.503	384.800	556.733	0.819	1.207	1.771	2.656
35	70.361	105.541	316.757	458.287	0.674	0.978	1.434	2.152
40	59.456	89.184	262.177	379.320	0.558	0.797	1.169	1.753
45	50.470	75.705	218.069	315.504	0.464	0.653	0.958	1.437
50	43.029	64.543	182.297	263.749	0.388	0.538	0.789	1.184
55	36.830	55.246	153.150	221.579	0.326	0.446	0.654	0.981
60	31.649	47.473	129.249	186.998	0.275	0.371	0.545	0.817
65	27.364	41.045	109.551	158.499	0.233	0.311	0.456	0.684
70	23.756	35.634	93.281	134.960	0.199	0.261	0.383	0.575
75	20.651	30.976	79.750	115.383	0.170	0.221	0.324	0.486
80	18.011	27.016	68.446	99.029	0.146	0.187	0.275	0.412
85	15.800	23.700	58.996	85.356	0.126	0.160	0.234	0.351
90	13.908	20.862	51.036	73.839	0.109	0.137	0.200	0.301
95	12.263	18.394	44.332	64.140	0.094	0.117	0.172	0.258
100	10.844	16.265	38.640	55.905	0.082	0.101	0.149	0.223
105	9.622	14.434	33.790	48.888	0.072	0.088	0.129	0.193
110	8.563	12.844	29.664	42.918	0.063	0.076	0.112	0.168
115	7.648	11.472	26.123	37.795	0.056	0.067	0.098	0.146
120	6.850	10.275	23.091	33.409	0.049	0.058	0.085	0.128
125	6.162	9.243	20.472	29.618	0.044	0.051	0.075	0.113
130	5.557	8.336	18.200	26.332	0.039	0.045	0.066	0.099
135	5.025	7.537	16.225	23.475	0.035	0.040	0.059	0.088
140	4.554	6.832	14.502	20.982	0.031	0.035	0.052	0.078
145	4.138	6.206	13.007	18.819	0.028	0.032	0.046	0.069
150	3.768	5.561	11.696	16.922	0.025	0.028	0.041	0.062

Detailed Resistance-Temperature Tables are downloadable from the following URL.
<http://search.murata.co.jp/Ceramy/CatsearchAction.do?sLang=en>

Continued on the following page.

NTC Thermistors Chip Type Temperature Characteristics (Center Value)

Continued from the preceding page.

Part Number	NCP□□XW472	NCP□□XW682	NCP□□XH103D	NCP□□XH103	NCP□□XV103	NCP□□XW153	NCP□□XW223	NCP15WL223
Resistance	4.7kΩ	6.8kΩ	10kΩ±0.5%	10kΩ	10kΩ	15kΩ	22kΩ	22kΩ
B-Constant	3950K	3950K	3380K±0.7%	3380K	3900K	3950K	3950K	4485K
Temp. (°C)	Resistance (kΩ)	Resistance (kΩ)	Resistance (kΩ)	Resistance (kΩ)	Resistance (kΩ)	Resistance (kΩ)	Resistance (kΩ)	Resistance (kΩ)
-40	162.279	234.787	197.390	195.652	328.996	517.912	759.605	1073.436
-35	116.474	168.515	149.390	148.171	237.387	371.724	545.196	753.900
-30	84.615	122.422	114.340	113.347	173.185	270.048	396.070	535.073
-25	62.173	89.953	88.381	87.559	127.773	198.426	291.025	383.590
-20	46.147	66.766	68.915	68.237	95.327	147.278	216.008	277.643
-15	34.604	50.066	54.166	53.650	71.746	110.439	161.977	202.813
-10	26.200	37.906	42.889	42.506	54.564	83.617	122.638	149.462
-5	20.018	28.963	34.196	33.892	41.813	63.888	93.702	111.082
0	15.423	22.313	27.445	27.219	32.330	49.221	72.191	83.233
5	11.984	17.338	22.165	22.021	25.194	38.245	56.093	62.858
10	9.380	13.571	18.010	17.926	19.785	29.936	43.907	47.831
15	7.399	10.705	14.720	14.674	15.651	23.613	34.633	36.664
20	5.877	8.503	12.099	12.081	12.468	18.756	27.509	28.304
25	4.700	6.800	10.000	10.000	10.000	15.000	22.000	22.000
30	3.783	5.474	8.309	8.315	8.072	12.074	17.709	17.214
35	3.064	4.434	6.939	6.948	6.556	9.780	14.344	13.557
40	2.497	3.613	5.824	5.834	5.356	7.969	11.688	10.744
45	2.046	2.961	4.911	4.917	4.401	6.531	9.578	8.566
50	1.686	2.440	4.160	4.161	3.635	5.382	7.894	6.871
55	1.397	2.022	3.539	3.535	3.019	4.459	6.540	5.544
60	1.164	1.683	3.024	3.014	2.521	3.713	5.446	4.498
65	0.974	1.409	2.593	2.586	2.115	3.108	4.559	3.669
70	0.819	1.185	2.233	2.228	1.781	2.613	3.832	3.009
75	0.692	1.001	1.929	1.925	1.509	2.208	3.239	2.479
80	0.587	0.849	1.673	1.669	1.284	1.873	2.748	2.052
85	0.500	0.724	1.455	1.452	1.097	1.597	2.342	1.707
90	0.428	0.620	1.270	1.268	0.941	1.367	2.004	1.426
95	0.368	0.532	1.112	1.110	0.810	1.174	1.722	1.196
100	0.318	0.459	0.976	0.974	0.701	1.013	1.486	1.008
105	0.275	0.398	0.860	0.858	0.608	0.878	1.287	0.852
110	0.239	0.346	0.759	0.758	0.530	0.763	1.119	0.724
115	0.208	0.302	0.673	0.672	0.463	0.665	0.975	0.617
120	0.182	0.264	0.598	0.596	0.406	0.582	0.854	0.528
125	0.160	0.232	0.532	0.531	0.358	0.511	0.750	0.454
130	0.141	0.204	0.476	0.474	0.316	0.451	0.661	0.391
135	0.125	0.181	0.426	0.424	0.280	0.399	0.585	0.339
140	0.111	0.160	0.383	0.381	0.249	0.354	0.519	0.294
145	0.099	0.143	0.344	0.342	0.222	0.315	0.462	0.256
150	0.088	0.127	0.311	0.309	0.198	0.281	0.412	0.223

Detailed Resistance-Temperature Tables are downloadable from the following URL.
<http://search.murata.co.jp/Ceramy/CatsearchAction.do?sLang=en>

Continued on the following page.

NTC Thermistors Chip Type Temperature Characteristics (Center Value)

↳ Continued from the preceding page.

Part Number	NCP□□WB333	NCP15WL333	NCP15WB473D	NCP18WB473D	NCP□□WB473	NCP15WL473	NCP□□WD683	NCP15WL683
Resistance	33kΩ	33kΩ	47kΩ±0.5%	47kΩ±0.5%	47kΩ	47kΩ	68kΩ	68kΩ
B-Constant	4050K	4485K	4050K±0.5%	4030K±0.5%	4050K	4485K	4150K	4485K
Temp. (°C)	Resistance (kΩ)	Resistance (kΩ)	Resistance (kΩ)	Resistance (kΩ)	Resistance (kΩ)	Resistance (kΩ)	Resistance (kΩ)	Resistance (kΩ)
-40	1227.263	1610.154	1690.586	1743.085	1747.920	2293.249	2735.359	3317.893
-35	874.449	1130.850	1215.318	1241.814	1245.428	1610.605	1937.391	2330.237
-30	630.851	802.609	882.908	896.201	898.485	1143.110	1389.345	1653.862
-25	460.457	575.385	647.911	654.460	655.802	819.487	1008.014	1185.641
-20	339.797	416.464	480.069	483.172	483.954	593.146	738.978	858.168
-15	253.363	304.219	359.009	360.367	360.850	433.281	547.456	626.875
-10	190.766	224.193	270.868	271.363	271.697	319.305	409.600	461.974
-5	144.964	166.623	206.113	206.204	206.463	237.312	309.217	343.345
0	111.087	124.850	158.126	158.051	158.214	177.816	235.606	257.266
5	85.842	94.287	122.267	122.145	122.259	134.287	180.980	194.287
10	66.861	71.747	95.256	95.145	95.227	102.184	140.139	147.841
15	52.470	54.996	74.754	74.676	74.730	78.327	109.344	113.325
20	41.471	42.455	59.075	59.038	59.065	60.467	85.929	87.484
25	33.000	33.000	47.000	47.000	47.000	47.000	68.000	68.000
30	26.430	25.822	37.636	37.667	37.643	36.776	54.167	53.208
35	21.298	20.335	30.326	30.381	30.334	28.962	43.421	41.903
40	17.266	16.115	24.583	24.654	24.591	22.952	35.016	33.208
45	14.076	12.849	20.043	20.124	20.048	18.301	28.406	26.477
50	11.538	10.306	16.433	16.518	16.433	14.679	23.166	21.237
55	9.506	8.317	13.545	13.631	13.539	11.845	18.997	17.137
60	7.870	6.748	11.223	11.306	11.209	9.610	15.657	13.904
65	6.549	5.504	9.345	9.424	9.328	7.839	12.967	11.342
70	5.475	4.513	7.818	7.892	7.798	6.427	10.794	9.299
75	4.595	3.718	6.571	6.639	6.544	5.296	9.021	7.662
80	3.874	3.078	5.548	5.609	5.518	4.384	7.575	6.343
85	3.282	2.560	4.704	4.759	4.674	3.646	6.387	5.276
90	2.789	2.139	4.004	4.054	3.972	3.046	5.407	4.407
95	2.379	1.794	3.422	3.468	3.388	2.555	4.598	3.697
100	2.038	1.511	2.936	2.977	2.902	2.152	3.922	3.114
105	1.751	1.278	2.528	2.566	2.494	1.820	3.359	2.634
110	1.509	1.085	2.184	2.220	2.150	1.546	2.887	2.236
115	1.306	0.925	1.893	1.927	1.860	1.318	2.489	1.907
120	1.134	0.792	1.646	1.679	1.615	1.128	2.155	1.632
125	0.987	0.681	1.436	1.468	1.406	0.970	1.870	1.403
130	0.862	0.587	1.256	1.288	1.227	0.836	1.629	1.209
135	0.755	0.508	1.102	1.133	1.075	0.724	1.423	1.047
140	0.663	0.441	0.969	0.999	0.945	0.628	1.247	0.908
145	0.584	0.384	0.854	0.884	0.831	0.546	1.096	0.790
150	0.516	0.335	0.755	0.783	0.735	0.477	0.966	0.690

Detailed Resistance-Temperature Tables are downloadable from the following URL.
<http://search.murata.co.jp/Ceramy/CatsearchAction.do?sLang=en>

Continued on the following page. ↗

NTC Thermistors Chip Type Temperature Characteristics (Center Value)

Continued from the preceding page.

Part Number	NCP15WF104D	NCP18WF104D	NCP18WF104F	NCP□□WF104	NCP15WL104	NCP15WL154	NCP□□WM154	NCP□□WM224
Resistance	100kΩ±0.5%	100kΩ±0.5%	100kΩ±1%	100kΩ	100kΩ	150kΩ	150kΩ	220kΩ
B-Constant	4250K±0.5%	4200K±0.5%	4200K±1%	4250K	4485K	4485K	4500K	4500K
Temp. (°C)	Resistance (kΩ)	Resistance (kΩ)	Resistance (kΩ)	Resistance (kΩ)	Resistance (kΩ)	Resistance (kΩ)	Resistance (kΩ)	Resistance (kΩ)
-40	4221.283	4205.686	4205.686	4397.119	4879.254	7318.881	7899.466	11585.884
-35	2995.044	2966.436	2966.436	3088.599	3426.818	5140.228	5466.118	8016.973
-30	2146.996	2118.789	2118.789	2197.225	2432.149	3648.224	3834.499	5623.931
-25	1554.599	1531.319	1531.319	1581.881	1743.590	2615.385	2720.523	3990.100
-20	1136.690	1118.422	1118.422	1151.037	1262.012	1893.018	1951.216	2861.784
-15	839.019	825.570	825.570	846.579	921.875	1382.813	1415.565	2076.162
-10	624.987	615.526	615.526	628.988	679.373	1019.059	1036.984	1520.909
-5	469.678	463.104	463.104	471.632	504.919	757.379	767.079	1125.049
0	355.975	351.706	351.706	357.012	378.333	567.499	572.667	839.912
5	272.011	269.305	269.305	272.500	285.717	428.575	431.264	632.521
10	209.489	207.891	207.891	209.710	217.414	326.121	327.405	480.194
15	162.559	161.722	161.722	162.651	166.654	249.981	250.538	367.455
20	127.057	126.723	126.723	127.080	128.653	192.979	193.166	283.310
25	100.000	100.000	100.000	100.000	100.000	150.000	150.000	220.000
30	79.222	79.439	79.439	79.222	78.247	117.370	117.281	172.012
35	63.167	63.509	63.509	63.167	61.622	92.433	92.293	135.364
40	50.677	51.084	51.084	50.677	48.835	73.252	73.090	107.198
45	40.904	41.336	41.336	40.904	38.937	58.406	58.240	85.419
50	33.195	33.628	33.628	33.195	31.231	46.846	46.665	68.441
55	27.091	27.510	27.510	27.091	25.202	37.803	37.605	55.153
60	22.224	22.621	22.621	22.224	20.448	30.671	30.453	44.665
65	18.323	18.692	18.692	18.323	16.679	25.018	24.804	36.379
70	15.184	15.525	15.525	15.184	13.675	20.513	20.293	29.763
75	12.635	12.947	12.947	12.635	11.268	16.902	16.679	24.462
80	10.566	10.849	10.849	10.566	9.329	13.993	13.776	20.205
85	8.873	9.129	9.129	8.873	7.758	11.638	11.428	16.761
90	7.481	7.713	7.713	7.481	6.481	9.721	9.520	13.962
95	6.337	6.546	6.546	6.337	5.437	8.155	7.966	11.684
100	5.384	5.572	5.572	5.384	4.580	6.869	6.688	9.809
105	4.594	4.764	4.764	4.594	3.873	5.810	5.639	8.270
110	3.934	4.087	4.087	3.934	3.289	4.933	4.772	6.998
115	3.380	3.518	3.518	3.380	2.804	4.206	4.052	5.942
120	2.916	3.040	3.040	2.916	2.400	3.601	3.454	5.067
125	2.522	2.634	2.634	2.522	2.064	3.096	2.955	4.334
130	2.190	2.290	2.290	2.190	1.778	2.667	2.536	3.719
135	1.907	1.998	1.998	1.907	1.540	2.310	2.182	3.200
140	1.665	1.748	1.748	1.665	1.336	2.004	1.884	2.763
145	1.459	1.533	1.533	1.459	1.162	1.743	1.632	2.394
150	1.282	1.349	1.349	1.282	1.014	1.521	1.418	2.079

Detailed Resistance-Temperature Tables are downloadable from the following URL.
<http://search.murata.co.jp/Ceramy/CatsearchAction.do?sLang=en>

Continued on the following page.

NTC Thermistors Chip Type Temperature Characteristics (Center Value)

↳ Continued from the preceding page.

■ Operating Temperature Range: -40°C to +125°C

Part Number	NCP□□WM474	Part Number	NCP15XC220	NCP15XC330	NCP15XC470	NCP15XC680	NCP15XF101	NCP15XF151
Resistance	470kΩ	Resistance	22Ω	33Ω	47Ω	68Ω	100Ω	150Ω
B-Constant	4500K	B-Constant	3100K	3100K	3100K	3100K	3250K	3250K
Temp. (°C)	Resistance (kΩ)	Temp. (°C)	Resistance (Ω)	Resistance (Ω)	Resistance (Ω)	Resistance (Ω)	Resistance (Ω)	Resistance (Ω)
-40	24751.661	-40	355.823	533.734	760.166	1099.815	1824.175	2736.262
-35	17127.169	-35	273.975	410.962	585.310	846.832	1390.685	2086.028
-30	12014.762	-30	213.003	319.504	455.051	658.372	1070.653	1605.979
-25	8524.305	-25	166.943	250.415	356.652	516.007	831.138	1246.708
-20	6113.811	-20	131.997	197.996	281.994	407.991	650.960	976.440
-15	4435.437	-15	105.318	157.978	224.998	325.529	514.441	771.661
-10	3249.216	-10	84.670	127.005	180.886	261.707	409.700	614.550
-5	2403.515	-5	68.628	102.942	146.614	212.123	328.877	493.315
0	1794.358	0	55.981	83.972	119.596	173.033	265.759	398.639
5	1351.294	5	45.859	68.789	97.972	141.747	215.785	323.677
10	1025.870	10	37.819	56.728	80.794	116.894	176.395	264.592
15	785.018	15	31.396	47.094	67.073	97.042	145.161	217.742
20	605.252	20	26.211	39.317	55.997	81.016	120.152	180.228
25	470.000	25	22.000	33.000	47.000	68.000	100.000	150.000
30	367.480	30	18.560	27.840	39.651	57.368	83.669	125.503
35	289.186	35	15.735	23.603	33.616	48.636	70.361	105.541
40	229.014	40	13.403	20.104	28.633	41.426	59.456	89.184
45	182.485	45	11.462	17.193	24.487	35.428	50.470	75.705
50	146.215	50	9.842	14.763	21.026	30.421	43.029	64.543
55	117.828	55	8.488	12.732	18.133	26.235	36.830	55.246
60	95.420	60	7.348	11.022	15.698	22.712	31.649	47.473
65	77.718	65	6.399	9.598	13.670	19.778	27.364	41.045
70	63.584	70	5.595	8.392	11.952	17.293	23.756	35.634
75	52.260	75	4.896	7.345	10.461	15.134	20.651	30.976
80	43.166	80	4.299	6.448	9.184	13.288	18.011	27.016
85	35.808	85	3.795	5.692	8.107	11.729	15.800	23.700
90	29.828	90	3.360	5.040	7.179	10.386	13.908	20.862
95	24.961	95	2.983	4.474	6.373	9.220	12.263	18.394
100	20.955	100	2.656	3.983	5.673	8.208	10.844	16.265
105	17.668	105	2.367	3.551	5.057	7.317	9.622	14.434
110	14.951	110	2.116	3.173	4.520	6.539	8.563	12.844
115	12.695	115	1.901	2.851	4.060	5.874	7.648	11.472
120	10.824	120	1.712	2.568	3.657	5.291	6.850	10.275
125	9.259	125	1.543	2.314	3.296	4.768	6.162	9.243
130	7.945							
135	6.837							
140	5.904							
145	5.113							
150	4.442							

Detailed Resistance-Temperature Tables are downloadable from the following URL.
<http://search.murata.co.jp/Ceramy/CatsearchAction.do?sLang=en>

Continued on the following page. ↗

NTC Thermistors Chip Type Temperature Characteristics (Center Value)

↳ Continued from the preceding page.

Part Number	NCP□□XM221	NCP□□XM331	NCP15XQ471	NCP15XQ681	NCP15XQ102	NCP□□XM472
Resistance	220Ω	330Ω	470Ω	680Ω	1.0kΩ	4.7kΩ
B-Constant	3500K	3500K	3650K	3650K	3650K	3500K
Temp. (°C)	Resistance (Ω)	Resistance (Ω)	Resistance (Ω)	Resistance (Ω)	Resistance (kΩ)	Resistance (kΩ)
-40	4947.904	7421.856	11822.473	17104.854	25.154	105.705
-35	3703.755	5555.632	8767.745	12685.248	18.655	79.126
-30	2798.873	4198.309	6570.224	9505.855	13.979	59.794
-25	2135.887	3203.831	4971.784	7193.219	10.578	45.630
-20	1645.037	2467.555	3796.933	5493.436	8.079	35.144
-15	1278.034	1917.051	2923.400	4229.599	6.220	27.303
-10	1000.620	1500.930	2269.599	3283.675	4.829	21.377
-5	789.612	1184.418	1775.225	2568.411	3.777	16.869
0	627.752	941.628	1399.050	2024.158	2.977	13.411
5	502.474	753.711	1110.220	1606.275	2.362	10.735
10	405.010	607.514	887.257	1283.691	1.888	8.653
15	328.480	492.720	713.463	1032.245	1.518	7.018
20	268.044	402.066	577.375	835.351	1.229	5.726
25	220.000	330.000	470.000	680.000	1.000	4.700
30	181.576	272.365	384.800	556.733	0.819	3.879
35	150.668	226.002	316.757	458.287	0.674	3.219
40	125.681	188.521	262.177	379.320	0.558	2.685
45	105.336	158.004	218.069	315.504	0.464	2.250
50	88.717	133.076	182.297	263.749	0.388	1.895
55	75.059	112.588	153.150	221.579	0.326	1.604
60	63.777	95.666	129.249	186.998	0.275	1.363
65	54.415	81.622	109.551	158.499	0.233	1.163
70	46.631	69.946	93.281	134.960	0.199	0.996
75	40.115	60.172	79.750	115.383	0.170	0.857
80	34.637	51.955	68.446	99.029	0.146	0.740
85	30.013	45.019	58.996	85.356	0.126	0.641
90	26.110	39.165	51.036	73.839	0.109	0.558
95	22.790	34.186	44.332	64.140	0.094	0.487
100	19.957	29.935	38.640	55.905	0.082	0.426
105	17.541	26.312	33.790	48.888	0.072	0.375
110	15.453	23.180	29.664	42.918	0.063	0.330
115	13.663	20.494	26.123	37.795	0.056	0.292
120	12.114	18.171	23.091	33.409	0.049	0.259
125	10.778	16.168	20.472	29.618	0.044	0.230

Detailed Resistance-Temperature Tables are downloadable from the following URL.
<http://search.murata.co.jp/Ceramy/CatsearchAction.do?sLang=en>

Continued on the following page. ↗

NTC Thermistors Chip Type Temperature Characteristics (Center Value)

Continued from the preceding page.

■ For Conductive Glue

Part Number	NCG18XH103	NCG18WF104
Resistance	10kΩ	100kΩ
B-Constant	3380K	4200K
Temp. (°C)	Resistance (kΩ)	Resistance (kΩ)
-55	481.258	13019.2917
-50	352.304	8807.8909
-45	261.060	6042.9955
-40	195.661	4205.6861
-35	148.177	2966.4355
-30	113.351	2118.7894
-25	87.562	1531.3193
-20	68.239	1118.4222
-15	53.651	825.5695
-10	42.507	615.5264
-5	33.893	463.1041
0	27.219	351.7064
5	22.021	269.3046
10	17.926	207.8907
15	14.674	161.7224
20	12.081	126.7225
25	10.000	100.0000
30	8.315	79.4390
35	6.948	63.5094
40	5.834	51.0835
45	4.917	41.3360
50	4.161	33.6281
55	3.535	27.5103
60	3.014	22.6211
65	2.586	18.6920
70	2.228	15.5246
75	1.925	12.9466
80	1.669	10.8488
85	1.452	9.1290
90	1.268	7.7128
95	1.110	6.5455
100	0.974	5.5722
105	0.858	4.7638
110	0.758	4.0868
115	0.672	3.5178
120	0.596	3.0403
125	0.531	2.6336
130	0.474	2.2902
135	0.424	1.9976
140	0.381	1.7475
145	0.342	1.5332
150	0.309	1.3491

Detailed Resistance-Temperature Tables are downloadable from the following URL.
<http://search.murata.co.jp/Ceramy/CatsearchAction.do?sLang=en>

NTC Thermistors Chip Type Specifications and Test Methods

■ NCP Series

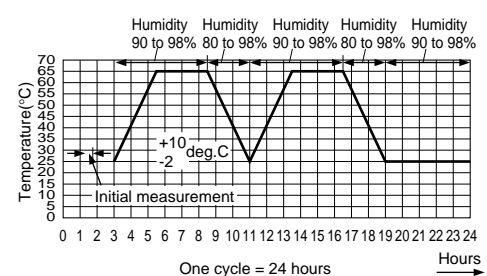
No.	AEC-Q200 Test Item	Specifications	AEC-Q200 Test Methods															
1	Pre- and Post-Stress Electrical Test	-	-															
2	High Temperature Exposure (Storage)	(*1) •Resistance(R25) change should be less than ±5%. •B-constant(B25/50) change should be less than ±2%. •No visible damage.	Leave continuously according to the following table for 1000 hours. <table border="1" style="margin-left: auto; margin-right: auto;"> <tr> <td>Operating Temp. Range: -40 to +150°C Type</td> <td>150±3°C</td> </tr> <tr> <td>Operating Temp. Range: -40 to +125°C Type</td> <td>125±3°C</td> </tr> </table> Measurement at 24±2 hours after test condition.	Operating Temp. Range: -40 to +150°C Type	150±3°C	Operating Temp. Range: -40 to +125°C Type	125±3°C											
Operating Temp. Range: -40 to +150°C Type	150±3°C																	
Operating Temp. Range: -40 to +125°C Type	125±3°C																	
3	Temperature Cycling	•Resistance(R25) change should be less than ±5%. •B-constant(B25/50) change should be less than ±2%. •No visible damage.	Perform 1000 cycles according to the four heat treatments listed in the following table. <table border="1" style="margin-left: auto; margin-right: auto;"> <thead> <tr> <th>Step</th> <th>1</th> <th>2</th> <th>3</th> <th>4</th> </tr> </thead> <tbody> <tr> <td>Temp. (deg.C)</td> <td>-55+0/-3</td> <td>Room Temp.</td> <td>125+3/-0</td> <td>Room Temp.</td> </tr> <tr> <td>Time (min.)</td> <td>15±3</td> <td>1</td> <td>15±3</td> <td>1</td> </tr> </tbody> </table> Measurement at 24±2 hours after test condition.	Step	1	2	3	4	Temp. (deg.C)	-55+0/-3	Room Temp.	125+3/-0	Room Temp.	Time (min.)	15±3	1	15±3	1
Step	1	2	3	4														
Temp. (deg.C)	-55+0/-3	Room Temp.	125+3/-0	Room Temp.														
Time (min.)	15±3	1	15±3	1														
4	Moisture Resistance	•Resistance(R25) change should be less than ±5%. •B-constant(B25/50) change should be less than ±2%. •No visible damage.	Apply the 24-hour heat (25 to 65 °C) and humidity (80 to 98%) treatment shown below, 10 consecutive times.  Measurement at 24±2 hours after test condition.															
5	Biased Humidity	(*2) •Resistance(R25) change should be less than ±10%. •B-constant(B25/50) change should be less than ±2%. •No visible damage.	85±2 °C, 85%RH in air for 1000 hours with Permissive Operating Current. Measurement at 24±2 hours after test condition.															
6	Operational Life	•Resistance(R25) change should be less than ±5%. •B-constant(B25/50) change should be less than ±2%. •No visible damage.	85±3 °C in air for 1000 hours with Permissive Operating Current. Measurement at 24±2 hours after test condition.															
7	External Visual	No defects of abnormalities.	Visual Inspection.															
8	Physical Dimension	Within the specified dimensions.	Using calipers															
9	Terminal Strength (Leaded)	N/A																
10	Resistance to Solvents	•Resistance(R25) change should be less than ±5%. •B-constant(B25/50) change should be less than ±2%. •No visible damage.	Per MIL-STD-202 Method 215 Solvent 1: 1 part (by volume) of isopropyl alcohol 3 parts (by volume) of mineral spirits.															
11	Mechanical Shock	•Resistance(R25) change should be less than ±5%. •B-constant(B25/50) change should be less than ±2%. •No visible damage.	Per MIL-STD-202 Method 213 Test Condition F 1500g's, 0.5ms, In 3 directions perpendicularly intersecting each other (total 18 times).															
12	Vibration	(*1) •Resistance(R25) change should be less than ±5%. •B-constant(B25/50) change should be less than ±2%. •No visible damage.	Simple harmonic motion between 10Hz to 2.0k Hz and back to 10 Hz of max. amplitude 1.5mm for 20 minutes. This motion should be applied 12 times in each of 3 mutually perpendicular directions (total of 36 times).															
13	Resistance to Soldering Heat	(*1) •Resistance(R25) change should be less than ±5%. •B-constant(B25/50) change should be less than ±2%. •No visible damage.	Per MIL-STD-202 Method 210 Test Condition B, 260 °C for 10 +/-1 seconds															

• The Test Condition specification (*1,*2) is applied to the follow P/N.

P/N: NCP15XH103**SR*, NCP15WL223**SR*, NCP15WL333**SR*, NCP15WL473**SR*, NCP15WL683**SR*, NCP15WL104**SR*,
 NCP15WL154**SR*, NCP15WB473**SR*, NCP15WF104**SR*, NCP18XH103**SR*

(*1) Resistance(R25) change should be less than 1%
 B-constant(B25/50) change should be less than 1%

(*2) Resistance(R25) change should be less than 5%
 B-constant(B25/50) change should be less than 1%

Continued on the following page.

NTC Thermistors Chip Type Specifications and Test Methods

Continued from the preceding page.

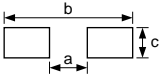
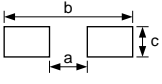
No.	AEC-Q200 Test Item	Specifications	AEC-Q200 Test Methods												
14	Thermal Shock	<ul style="list-style-type: none"> •Resistance(R₂₅) change should be less than ±5%. •B-constant(B_{25/50}) change should be less than ±2%. •No visible damage. 	Perform 300 cycles according to the two heat treatments listed in the following table. (Maximum transfer time is 20 seconds.) <table border="1"> <thead> <tr> <th>Step</th> <th>1</th> <th>2</th> </tr> </thead> <tbody> <tr> <td>Temp. (°C)</td> <td>-55+0/-3</td> <td>125+3/-0</td> </tr> <tr> <td>Time (min.)</td> <td>15±3</td> <td>15±3</td> </tr> </tbody> </table> Measurement at 24±2 hours after test condition.	Step	1	2	Temp. (°C)	-55+0/-3	125+3/-0	Time (min.)	15±3	15±3			
Step	1	2													
Temp. (°C)	-55+0/-3	125+3/-0													
Time (min.)	15±3	15±3													
15	ESD	<ul style="list-style-type: none"> •Resistance(R₂₅) change should be less than ±5%. •B-constant(B_{25/50}) change should be less than ±2%. •No visible damage. 	Per AEC-Q200-002												
16	Solderability	Minimum 95% of the whole electrode surface should be covered with solder.	Per J-STD-002 SMD b) Method B @ 215 °C category 3.												
17	Electrical Characterization	Within the specified tolerance.	Resistance at 25 °C. B-constant (B ₂₅₋₅₀)												
18	Flammability	N/A													
19	Board Flex	(*1) <ul style="list-style-type: none"> •Resistance(R₂₅) change should be less than ±5%. •B-constant(B_{25/50}) change should be less than ±2%. •No visible damage. 	Per AEC-Q200-005 Bend the board 2.0mm for 60 seconds. Use the follow land size. <table border="1"> <thead> <tr> <th>Type</th> <th>a</th> <th>b</th> <th>c</th> </tr> </thead> <tbody> <tr> <td>NCP15****SRC</td> <td>0.4</td> <td>1.2</td> <td>0.5</td> </tr> <tr> <td>NCP18****SRB</td> <td>0.6</td> <td>1.8</td> <td>0.6</td> </tr> </tbody> </table> (in mm) 	Type	a	b	c	NCP15****SRC	0.4	1.2	0.5	NCP18****SRB	0.6	1.8	0.6
Type	a	b	c												
NCP15****SRC	0.4	1.2	0.5												
NCP18****SRB	0.6	1.8	0.6												
20	Terminal Strength (SMD)	(*1) <ul style="list-style-type: none"> •Resistance(R₂₅) change should be less than ±5%. •B-constant(B_{25/50}) change should be less than ±2%. •No visible damage. 	Per AEC-Q200-006 Apply a *17.7N force to the side of device for 60 seconds. Use follow land size. *4.9N (NCP15****SRC) <table border="1"> <thead> <tr> <th>Type</th> <th>a</th> <th>b</th> <th>c</th> </tr> </thead> <tbody> <tr> <td>NCP15****SRC</td> <td>0.4</td> <td>1.5</td> <td>0.5</td> </tr> <tr> <td>NCP18****SRB</td> <td>1.0</td> <td>3.0</td> <td>1.2</td> </tr> </tbody> </table> (in mm) 	Type	a	b	c	NCP15****SRC	0.4	1.5	0.5	NCP18****SRB	1.0	3.0	1.2
Type	a	b	c												
NCP15****SRC	0.4	1.5	0.5												
NCP18****SRB	1.0	3.0	1.2												

• The Test Condition specification (*1,*2) is applied to the follow P/N.

P/N: NCP15XH103**SR*, NCP15WL223**SR*, NCP15WL333**SR*, NCP15WL473**SR*, NCP15WL683**SR*, NCP15WL104**SR*,
 NCP15WL154**SR*, NCP15WB473**SR*, NCP15WF104**SR*, NCP18XH103**SR*

(*1) Resistance(R₂₅) change should be less than 1%
 B-constant(B_{25/50}) change should be less than 1%

(*2) Resistance(R₂₅) change should be less than 5%
 B-constant(B_{25/50}) change should be less than 1%

NTC Thermistors Chip Type Specifications and Test Methods

■ NCG18 Series (For Conductive Glue)

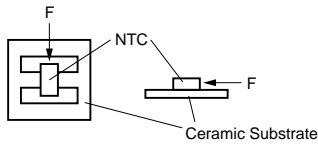
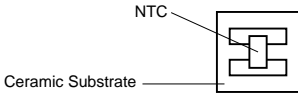
No.	Item	Rating value	Method of Examination								
1	Dry Heat	<ul style="list-style-type: none"> Resistance (R_{25}) change should be less than $\pm 3\%$ B-constant (B_{25-50}) change should be less than $\pm 1\%$ No visible damage. 	150 \pm 3°C in air, for 1000 +48/-0 hours without loading.								
2	Cold	<ul style="list-style-type: none"> Resistance (R_{25}) change should be less than $\pm 1\%$ B-constant (B_{25-50}) change should be less than $\pm 1\%$ No visible damage. 	-40 \pm 3°C in air, for 1000 +48/-0 hours without loading.								
3	Damp Heat	<ul style="list-style-type: none"> Resistance (R_{25}) change should be less than $\pm 3\%$ B-constant (B_{25-50}) change should be less than $\pm 1\%$ No visible damage. 	60 \pm 2°C, 90 to 95%RH in air, for 1000 +48/-0 hours without loading.								
4	High Temperature Load		150 \pm 3°C in air, with Permissive Operating Current (D.C. 0.31mA) for 1000 +48/-0 hours.								
5	High Temperature Humidity Load		85 \pm 2°C, 85%RH in air, with Permissive Operating Current (D.C. 0.31mA) for 1000 +48/-0 hours.								
6	Thermal Shock	<ul style="list-style-type: none"> Resistance (R_{25}) change should be less than $\pm 3\%$ B-constant (B_{25-50}) change should be less than $\pm 1\%$ No visible damage. 	1000 cycles of the following sequence without loading.								
			<table border="1"> <thead> <tr> <th>Step</th> <th>Temp. (°C)</th> <th>Time (minute)</th> </tr> </thead> <tbody> <tr> <td>1</td> <td>-55+0/-3</td> <td>15</td> </tr> <tr> <td>2</td> <td>+150+3/-0</td> <td>15</td> </tr> </tbody> </table>	Step	Temp. (°C)	Time (minute)	1	-55+0/-3	15	2	+150+3/-0
Step	Temp. (°C)	Time (minute)									
1	-55+0/-3	15									
2	+150+3/-0	15									
7	Robustness of Electrode	<ul style="list-style-type: none"> No peeling of the electrodes. 	Mount NTC Thermistor with conductive glue on Ceramic substrate, and apply 4.90N of force as shown below: 								
8	Vibration Resistant	<ul style="list-style-type: none"> Resistance (R_{25}) change should be less than $\pm 1\%$ B-constant (B_{25-50}) change should be less than $\pm 1\%$ No visible damage. 	Solder NTC Thermistor on the Glass Epoxy PCB as shown below. Frequency: 10Hz to 2000Hz to 10Hz (20min.) Max. amplitude: 3.0mm Vibrated for a period of 4hrs. in three (3) directions perpendicularly intersecting each other (for total of 12hrs.). 								

- NTC Thermistor should be mounted on the Ceramic substrate with "Standard Land Dimensions" by our recommendable conductive glue (PC3000: Manufactured by Heraeus) and be tested. Thickness of the conductive glue screening should be 50 μ m.
- R_{25} means the zero-power resistance at 25°C.
- B_{25-50} is calculated by the zero-power resistances of NTC Thermistor at 25°C and at 50°C.
- After each test, NTC Thermistor should be kept for 1 hour at room temperature (normal humidity and normal atmospheric pressure). Then the resistances (R_{25} and R_{50}) should be measured and the appearance should be visually examined.
- In the case that of R_{25} or B_{25-50} changes are greater than the specified value due to the method of mounting with conductive glue, these specifications should be judged by an evaluation with the chip only (not mounting).

NTC Thermistors Chip Type △Caution/Notice

■ △Caution (Storage and Operating Conditions)

This product is designed for application in an ordinary environment (normal room temperature, humidity and atmospheric pressure).

Do not use under the following conditions because all of these factors can deteriorate the product characteristics or cause failures and burn-out.

1. Corrosive gas or deoxidizing gas
(Chlorine gas, Hydrogen sulfide gas, Ammonia gas, Sulfuric acid gas, Nitric oxide gas, etc.)
2. Volatile or flammable gas
3. Dusty conditions
4. Under vacuum, or under high or low pressure
5. Wet or humid locations
6. Places with salt water, oils, chemical liquids or organic solvents
7. Strong vibrations
8. Other places where similar hazardous conditions exist

■ △Caution (Other)

Be sure to provide an appropriate fail-safe function on your product to prevent secondary damages that may be caused by the abnormal function or the failure of our product.

■ Notice (Storage and Operating Conditions)

To keep the mounting nature of product from declining, the following storage conditions are recommended.

1. Storage condition:
Temperature -10 to +40°C
Humidity less than 75%RH (not dewing condition)
2. Storage term:
Use this product within 6 months after delivery by first-in and first-out stocking system.
3. Storage place:
Do not store this product in corrosive gas (Sulfuric acid gas, Chlorine gas, etc.) or in direct sunlight.

■ Notice (Rating)

Use this product within the specified temperature range.

Higher temperature may cause deterioration of the characteristics or the material quality of this product.

NTC Thermistors Chip Type ⚠ Caution/Notice

■ Notice (Soldering and Mounting) NCP15/18 Series

1. Mounting Position

Choose a mounting position that minimizes the stress imposed on the chip during flexing or bending of the board.

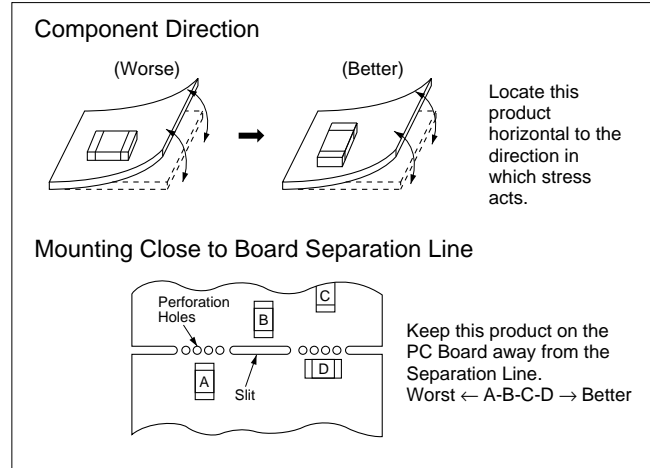

2. Allowable Soldering Temperature and Time

- (a) Solder within the temperature and time combinations, indicated by the slanted lines in the following graphs.
- (b) Excessive soldering conditions may cause dissolution of metalization or deterioration of solder-wetting on the external electrode.
- (c) In the case of repeated soldering, the accumulated soldering time should be within the range shown in the following figures. (For example, Reflow peak temperature: 260°C, twice -> The total accumulated soldering time at 260°C is within 30 seconds.)

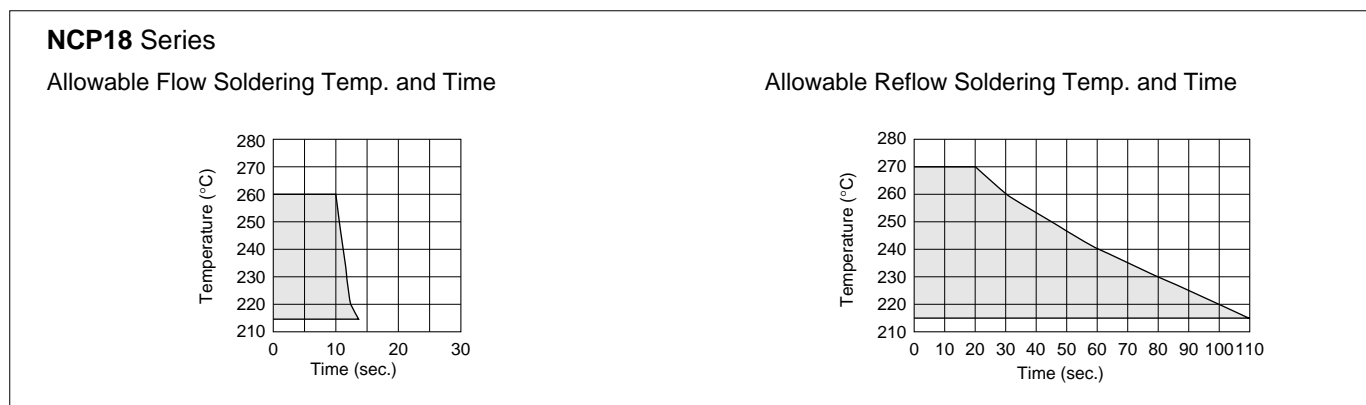
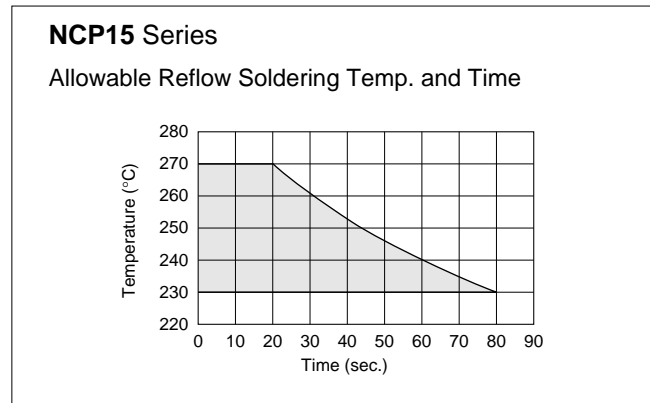

Continued on the following page. ↗

NTC Thermistors Chip Type ⚠Caution/Notice

Continued from the preceding page.

3. Recommendable Temperature Profile for Soldering

- (a) Insufficient preheating may cause a crack on the ceramic body. The difference between preheating temperature and maximum temperature in the profile shall be 100 °C.
 (b) Rapid cooling by dipping in solvent or by other means is not recommended.

* In the case of repeated soldering, the accumulated soldering time should be within the range shown in "2. Allowable Soldering Temperature and Time."

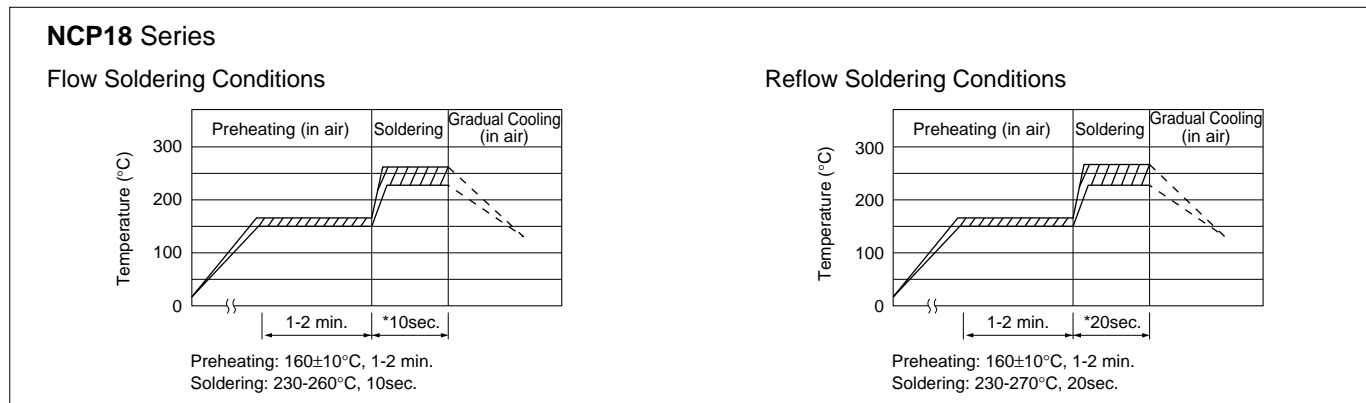
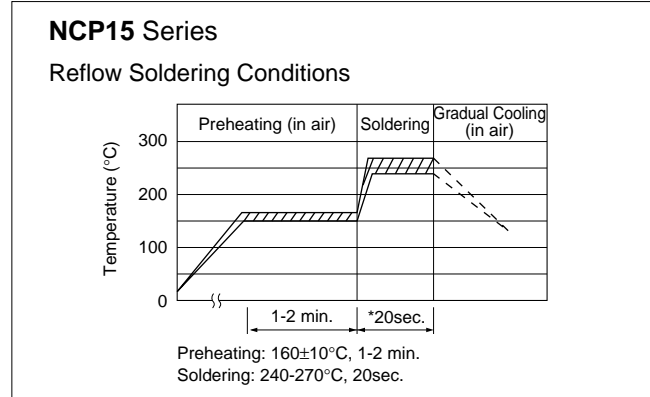

4. Solder and Flux

(1) Solder and Paste

(a) Reflow Soldering: NCP15/NCP18 Series

Use RA/RMA type or equivalent type of solder paste.

For your reference, we are using the solder paste below for any internal tests of this product.

•RMA9086 90-4-M20 (Sn:Pb=63wt%:37wt%)

(Manufactured by Alpha Metals Japan Ltd.)

•M705-221BM5-42-11

(Sn:Ag:Cu=96.5wt%:3.0wt%:0.5wt%)

(Manufactured by Senju Metal Industry Co., Ltd.)

(b) Flow Soldering: NCP18 Series

We are using the following solder paste for any internal tests of this product.

•Sn:Pb=63wt%:37wt%

•Sn:Ag:Cu=96.5wt%:3.0wt%:0.5wt%

(2) Flux

Use rosin type flux in the soldering process.

If the flux below is used, some problems might be caused in the product characteristics and reliability. Please do not use these types of flux.

• Strong acidic flux (with halide content exceeding 0.1wt%).

• Water-soluble flux

(*Water-soluble flux can be defined as non-rosin type flux including wash-type flux and non-wash-type flux.)

5. Cleaning Conditions

For removing the flux after soldering, observe the following points in order to avoid deterioration of the characteristics or any change of the external electrodes' quality.

- Please keep mounted parts and the substrate from an occurrence of resonance in ultrasonic cleaning.
- Please do not clean the products in the case of using a non-washed type flux.

	NCP15	NCP18
Solvent	Isopropyl Alcohol	Isopropyl Alcohol
Dipping Cleaning	Less than 5 minutes at room temp. or less than 2 minutes at 40°C max.	Less than 5 minutes at room temp. or less than 2 minutes at 40°C max.
Ultrasonic Cleaning	Less than 5 minutes 20W/ℓ Frequency of 28 to 40kHz.	Less than 1 minute 20W/ℓ Frequency of several 10 to 100kHz.
Drying	After cleaning, promptly dry this product.	

Continued on the following page. ↗

NTC Thermistors Chip Type ⚠Caution/Notice

↳ Continued from the preceding page.

6. Printing Conditions of Solder Paste

- The amount of solder is critical. Standard height of fillet is shown in the table below.
- Too much soldering may cause mechanical stress, resulting in cracking, mechanical and/or electronic damage.

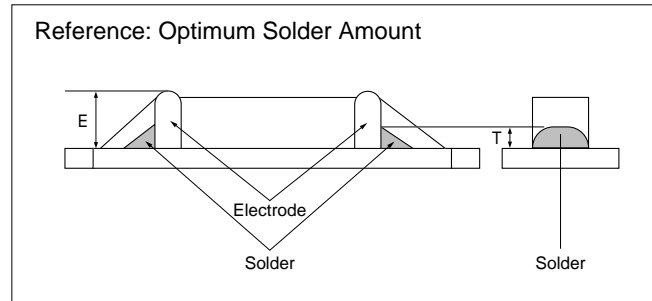

Part Number	The Solder Paste Thickness	T
NCP15	150μm	$1/3E \leq T \leq E$
NCP18	200μm	$0.2\text{mm} \leq T \leq E$

7. Adhesive Application and Curing

- Thin or insufficient adhesive may result in loose component contact with land during flow soldering.
- Low viscosity adhesive causes chips to slip after mounting.

■ Notice (Mounting) NCG18 Series

In your mounting process, observe the following points in order to avoid deterioration of the characteristics or destruction of this product. The mounting quality of this product may also be affected by the mounting conditions, shown in the points below.

1. Recommendable Land Size

Too small a land size parameter 'a' may cause an electric short mode of this product by conductive glue expanding on the surface of this product on mounting.

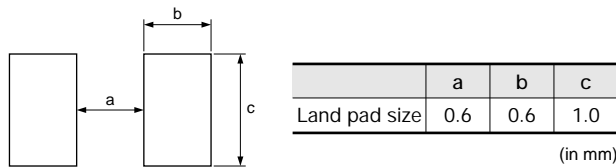

2. Recommendable Conductive Glue

- PC3000 (Manufactured by Heraeus)

■ Notice (Handling)

The ceramic of this product is fragile, and care must be taken not to load an excessive press - force or to give a shock at handling. Such forces may cause cracking or chipping.

3. Screening Conditions of Conductive glue

(1) Recommendable Screening Size

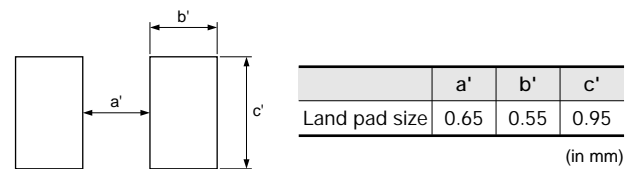

(2) Recommendable thickness of conductive glue screening shall be 50μm.

(3) Too much conductive glue gives an electric short mode of this product by conductive glue expanding on the surface of this product on mounting.

4. There is a possibility of unexpected failure in your mounting process, caused by mounting conditions. Please evaluate whether this product is correctly mounted under your mounting conditions.

NTC/PTC Thermistors for Automotive



NTC Thermistor Thermo String Type for Temperature Sensor

This product is a small flexible lead type NTC Thermistor with a small head and a thin lead wire.

■ Features

1. High accuracy and high sensibility temperature sensing is available in a small and highly accurate NTC Thermistor.
2. Narrow space temperature sensing is available from the small sensing head and the thin lead wire.
3. Flexibility and a wide variety of lengths (25 mm to 150mm) enables the design of flexible temperature sensing architectures.
4. This product is compatible with our 0402 (EIA) size chip Thermistor.
5. Excellent long-time aging stability
6. This is a halogen-free product.*
 * Cl= max.900ppm,
 Br=max.900ppm and Cl+Br=max.1500ppm
7. Lead is not contained in the product.

■ Applications

1. Car audio, car navigation
2. Various engine control units
3. Circuits for ETC equipment
4. Various motor driving circuits
5. Temperature compensation for various circuits

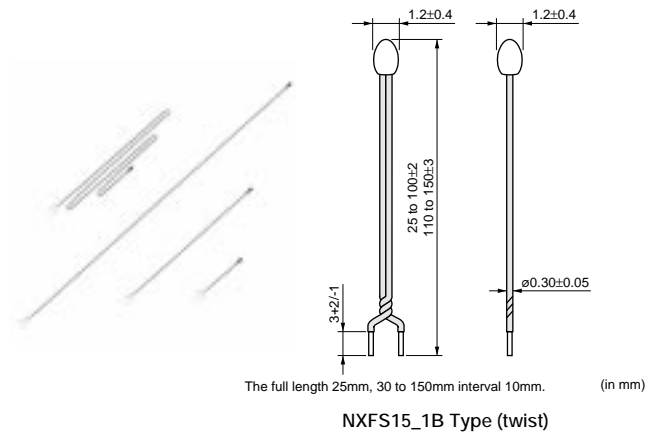

NXFS15_1B Type (twist)

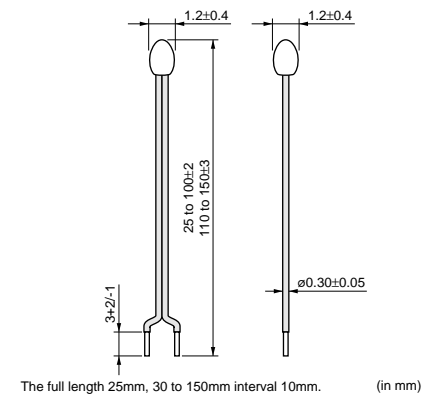

NXFS15_2B Type (without twist)

Part Number	Resistance (25°C) (ohm)	B-Constant (25-50°C) (K)	B-Constant (25-80°C) (Reference Value) (K)	B-Constant (25-85°C) (Reference Value) (K)	B-Constant (25-100°C) (Reference Value) (K)	Operating Current for Sensor (25°C) (mA)	Rated Electric Power (25°C) (mW)	Typical Dissipation Constant (25°C) (mW/°C)	Thermal Time Constant (25°C) (s)
NXFS15XH103FA□B□□□	10k ±1%	3380 ±1%	3423	3431	3452	0.12	7.5	1.5	4
NXFS15WB473FA□B□□□	47k ±1%	4050 ±1%	4091	4097	4114	0.06	7.5	1.5	4
NXFS15WF104FA□B□□□	100k ±1%	4250 ±1%	4303	4311	4334	0.04	7.5	1.5	4

□ is filled with lead shape (1: twist, 2: without twist).

□□□ is filled with total-length codes. (25mm, 30-150mm interval 10mm, ex. 050=50mm)

Operating Current for Sensor raises Thermistor's temperature by 0.1°C.

Rated Electric Power is necessary electric power for Thermistor's temperature to rise 5°C by self heating at 25°C in still air.

Operating Temperature Range: -40°C to +150°C

NTC Thermistors Thermo String Type Temperature Characteristics (Center Value)

Part Number	NXFS15XH103	NXFS15WB473	NXFS15WF104
Resistance	10kΩ	47kΩ	100kΩ
B-Constant	3380K	4050K	4250K
Temp. (°C)	Resistance (kΩ)	Resistance (kΩ)	Resistance (kΩ)
-40	197.388	1690.59	4221.28
-35	149.395	1215.32	2995.04
-30	114.345	882.908	2147.00
-25	88.381	647.911	1554.60
-20	68.915	480.069	1136.69
-15	54.166	359.009	839.019
-10	42.889	270.868	624.987
-5	34.196	206.113	469.678
0	27.445	158.126	355.975
5	22.165	122.267	272.011
10	18.010	95.256	209.489
15	14.720	74.754	162.559
20	12.099	59.075	127.057
25	10.000	47.000	100.000
30	8.309	37.636	79.222
35	6.939	30.326	63.167
40	5.824	24.583	50.677
45	4.911	20.043	40.904
50	4.160	16.433	33.195
55	3.539	13.545	27.091
60	3.024	11.223	22.224
65	2.593	9.345	18.323
70	2.233	7.818	15.184
75	1.929	6.571	12.635
80	1.673	5.548	10.566
85	1.455	4.704	8.873
90	1.270	4.004	7.481
95	1.112	3.422	6.337
100	0.976	2.936	5.384
105	0.860	2.528	4.594
110	0.759	2.184	3.934
115	0.673	1.893	3.380
120	0.598	1.646	2.916
125	0.532	1.436	2.522
130	0.476	1.256	2.190
135	0.426	1.102	1.907
140	0.383	0.969	1.665
145	0.344	0.854	1.459
150	0.311	0.755	1.282

Detailed Resistance - Temperature Tables are downloadable from the following URL.
<http://search.murata.co.jp/Ceramy/CatsearchAction.do?sLang=en>

NTC Thermistors Thermo String Type Specifications and Test Methods

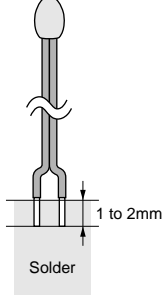
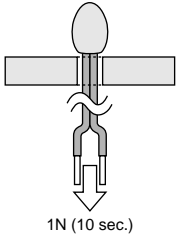
No.	Item	Specifications	Test Methods
1	High Temperature Storage Test 1	· Resistance (R25°C) fluctuation rate: less than ±1%. · B-Constant (B25/50°C) fluctuation rate: less than ±1%.	125±2°C in air, for 1000 +48/-0 hours without loading.
2	Low Temperature Storage Test		-40 +0/-3°C in air, for 1000 +48/-0 hours without loading.
3	High Temperature Storage Test 2	· Resistance (R25°C) fluctuation rate: less than ±5%. · B-Constant (B25/50°C) fluctuation rate: less than ±2%.	150±2°C in air, for 1000 +48/-0 hours without loading.
4	High Temperature Load		150±2°C in air, with 'Operating Current for Sensor' for 1000 +48/-0 hrs.
5	Humidity Storage Test	· Resistance (R25°C) fluctuation rate: less than ±2%. · B-Constant (B25/50°C) fluctuation rate: less than ±1%.	85±2°C, 85%RH in air, for 1000 +48/-0 hours without loading.
6	High Humidity Load test		85±2°C, 85%RH in air with 'Operating Current for Sensor,' for 1000 +48/-0 hours.
7	Thermal Shock	· Resistance (R25°C) fluctuation rate: less than ±3%. · B-Constant (B25/85°C) fluctuation rate: less than ±1%.	-55 +0/-3°C, 30 minutes in air +150 +3/-0°C, 30 minutes in air (1 cycle) Continuous 1000 cycles, without loading.
8	Temperature Cycle		-55 +0/-3°C, 30 minutes in air +25±2°C, 10 to 15 minutes in air +125 +3/-0°C, 30 minutes in air +25 +2/-0°C, 10 to 15 minutes in air (1 cycle) Continuous 1000 cycles, without loading.
9	Insulation Break - down Voltage	· No damage electrical characteristics on DC100 V, 1 min.	2mm length of coating resin from the top of Thermistor is to be dipped into beads of lead (Pb), and DC100V is applied to circuit between beads of lead (Pb) and lead wire for 1 minute.
10	Resistance to Soldering Heat	· Resistance (R25°C) fluctuation rate: less than ±1%. · B-Constant (B25/50°C) fluctuation rate: less than ±1%.	Both lead wires are dipped into 350±10°C solder for 3.5±0.5 seconds, or 260±5°C solder for 10±1 seconds according to Fig-1 (solder <JIS Z 3282 H60A>).  Fig-1
11	Solderability	· More than 90% of lead wire surface shall be covered by solder.	Both lead wires are dipped into flux (25wt% Colophony <JIS K 5902> isopropyl alcohol <JIS K 8839>) for 5 to 10 seconds. Then both lead wires are dipped into 235±5°C solder <JIS Z 3282 H60A> for 2±0.5 seconds according to Fig-1.
12	Lead Wire Pull Strength	· Resistance (R25°C) fluctuation rate: less than ±1%. · B-Constant (B25/50°C) fluctuation rate: less than ±1%.	The lead wire shall be inserted in a ø1.0mm hole until resin part contacts with a substrate as shown in Fig-2. And 1N force for 10 seconds shall be applied to the lead wire.  Fig-2

* · R25 is zero-power resistance at 25°C.
 · B25/50 is calculated by zero-power resistance of Thermistor in 25°C -50°C.
 · After each test, NTC Thermistor should be kept for 1 hour at room temperature (normal humidity and normal atmospheric pressure).

Continued on the following page.

NTC Thermistors Thermo String Type Specifications and Test Methods

Continued from the preceding page.

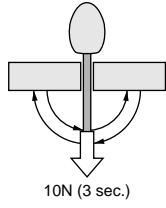
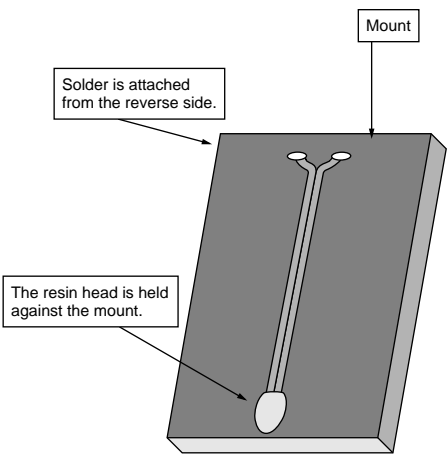
No.	Item	Specifications	Test Methods
13	Lead Wire Bending Strength	<ul style="list-style-type: none"> Lead wire does not break. 	<p>Hold the lead wires as in Fig-3. Bend by 90 degrees and again bend back to the initial position. Then bend to the other side by 90 degrees and again bend back to the initial position. After bending process, 10N force for 3 seconds shall be applied to the lead wire.</p>  <p style="text-align: center;">Fig-3</p>
14	Free Fall		<p>NTC Thermistor shall be dropped without any force onto concrete floor from 1 meter height one time.</p>
15	Vibration	<ul style="list-style-type: none"> Resistance (R25°C) fluctuation rate: less than ±1%. B-Constant (B25/50°C) fluctuation rate: less than ±1%. No visible damage at resin part. 	<p>NTC Thermistor shall be fixed to the vibration test equipment as shown below. Frequency: 10Hz to 2000Hz to 10Hz (20min.) Max. amplitude: 3.0mm Vibrated for a period of 2hrs. in three (3) directions perpendicularly intersecting each other (for total of 6hrs.)</p> 

4

* · R25 is zero-power resistance at 25°C.
 · B25/50 is calculated by zero-power resistance of Thermistor in 25°C -50°C.
 · After each test, NTC Thermistor should be kept for 1 hour at room temperature (normal humidity and normal atmospheric pressure).

NTC Thermistors Thermo String Type ⚠Caution/Notice

■ ⚠Caution (Storage and Operating Conditions)

This product is designed for application in an ordinary environment (normal room temperature, humidity and atmospheric pressure).

Do not use under the following conditions because all of these factors can deteriorate the product characteristics or cause failures and burn-out.

1. Corrosive gas or deoxidizing gas
(Chlorine gas, Hydrogen sulfide gas, Ammonia gas, Sulfuric acid gas, Nitric oxide gas, etc.)

2. Volatile or flammable gas
3. Dusty conditions
4. Under vacuum, or under high or low pressure
5. Wet or humid locations
6. Places with salt water, oils, chemical liquids or organic solvents
7. Strong vibrations
8. Other places where similar hazardous conditions exist

■ ⚠Caution (Other)

Be sure to provide an appropriate fail-safe function on your product to prevent secondary damages that may be caused by the abnormal function or the failure of our product.

4

■ Notice (Storage and Operating Conditions)

To keep solderability of product from declining, the following storage conditions are recommended.

1. Storage condition:
Temperature -10 to +40°C
Humidity less than 75%RH (not dewing condition)
2. Storage term:
Use this product within 6 months after delivery by first-in and first-out stocking system.

3. Storage place:
Do not store this product in corrosive gas (Sulfuric acid gas, Chlorine gas, etc.) or in direct sunlight.

■ Notice (Rating)

Use this product within the specified temperature range.

Higher temperature may cause deterioration of the characteristics or the material quality of this product.

■ Notice (Soldering and Mounting)

Please note as shown below when you mount this product.

1. Do not melt solder in the resin head when you solder this product. If you do so, it has a possibility of wire break, electric short mode failure and wire coating break.
In case you cut the lead wire of this product less than 20mm from the resin head, the heat of the melted solder at the lead wire edge is propagated easily to the resin head along the lead wire.
2. Do not touch the resin head directly with the soldering iron. It may cause the melting of solder in the resin head.
3. Do not separate the parallel lead wires 10mm or less from the resin head, when you separate parallel lead wires.
4. If you mold this product by resin, please evaluate the quality of this product before you use it.
5. Do not bend the lead wire radius 1mm or less when you bend the lead wire.

■ Notice (Handling)

The ceramic of this product is fragile, and care must be taken not to load an excessive press - force or to give a shock at handling.

Such forces may cause cracking or chipping.

NTC/PTC Thermistors for Automotive



PTC Thermistor (POSISTOR®) for Overheat Sensing Chip Type 0603 (1608) Size

This chip "POSISTOR" is an SMD type for overheat sensing in power transistors, power diodes and power ICs in hybrid circuits.

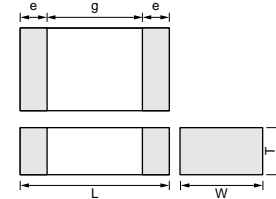

■ Features

1. The SMD type's small size and light weight are helpful in miniaturizing the circuit.
2. Excellent thermal response.
3. Elements of solid-state construction provide excellent mechanical vibration and impact resistance.
4. Contactless operation provides prolonged service life and noiseless operation.
5. Lead is not contained in the terminations.

Part Number	Dimensions (mm)				
	L	W	T	e	g
PRF18_RB	1.6±0.15	0.8±0.15	0.8±0.15	0.1 to 0.6	-

Chip Type 0603 (1608) Size

Part Number	Sensing Temperature (at 4.7k ohm) (°C)	Sensing Temperature (at 47k ohm) (°C)	Maximum Voltage (V)	Resistance (at 25°C) (ohm)
PRF18AS471QS5RB	145 ±5°C	-	32	470 ±50%
PRF18AR471QS5RB	135 ±5°C	150 ±7°C	32	470 ±50%
PRF18BA471QS5RB	125 ±5°C	140 ±7°C	32	470 ±50%
PRF18BB471QS5RB	115 ±5°C	130 ±7°C	32	470 ±50%
PRF18BC471QS5RB	105 ±5°C	120 ±7°C	32	470 ±50%
PRF18BD471QS5RB	95 ±5°C	110 ±7°C	32	470 ±50%
PRF18BE471QS5RB	85 ±5°C	100 ±7°C	32	470 ±50%
PRF18BF471QS5RB	75 ±5°C	90 ±7°C	32	470 ±50%
PRF18BG471QS5RB	65 ±5°C	80 ±7°C	32	470 ±50%

This product is applied to flow/reflow soldering.
 Operating Temperature Range: -40°C to +150°C

5

Chip Tight Tolerance Type 0603 (1608) Size

Part Number	Sensing Temperature (at 4.7k ohm) (°C)	Sensing Temperature (at 47k ohm) (°C)	Maximum Voltage (V)	Resistance (at 25°C) (ohm)
PRF18BB471RS5RB	115 ±3°C	130 ±7°C	32	470 ±50%
PRF18BC471RS5RB	105 ±3°C	120 ±7°C	32	470 ±50%
PRF18BD471RS5RB	95 ±3°C	110 ±7°C	32	470 ±50%
PRF18BE471RS5RB	85 ±3°C	100 ±7°C	32	470 ±50%
PRF18BF471RS5RB	75 ±3°C	90 ±7°C	32	470 ±50%
PRF18BG471RS5RB	65 ±3°C	80 ±7°C	32	470 ±50%

This product is applied to flow/reflow soldering.
 Operating Temperature Range: -40°C to +150°C



■ Standard Land Pattern Dimensions

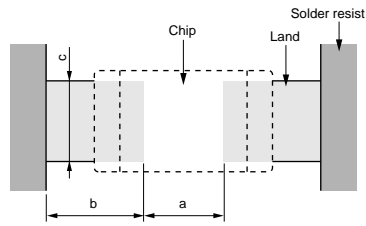

Part Number	Soldering Methods	Dimensions (mm)			
		Chip (L×W)	a	b	c
PRF18	Flow Soldering	1.6×0.8	0.6-1.0	0.8-0.9	0.6-0.8
	Reflow Soldering		0.6-0.8	0.6-0.7	0.6-0.8

■ Resistance - Temperature Characteristics (Typical)

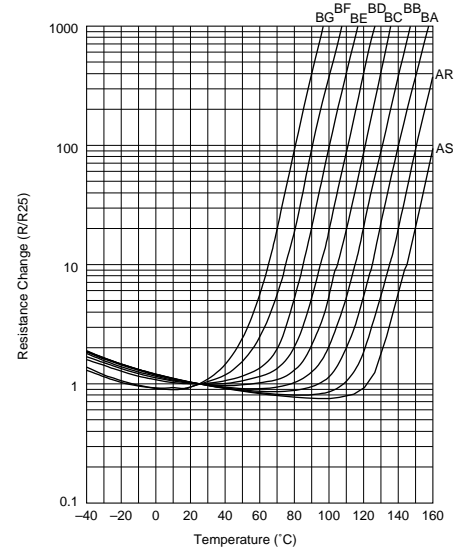

■ Overheat Protection Circuit

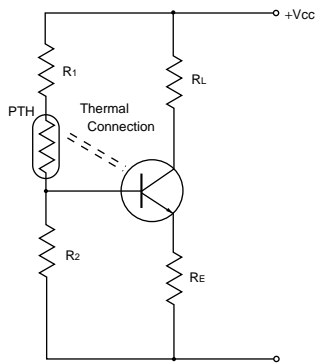

■ Overheat Sensing Circuit

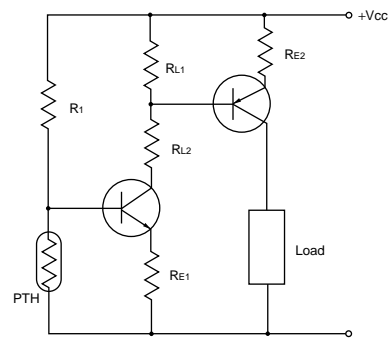

■ Resistance - Temperature Characteristics Range (Ref. Only)

PRF18AS471QS5RB

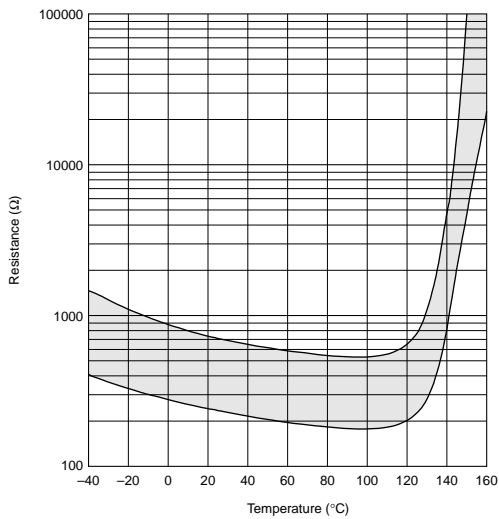

PRF18AR471QS5RB

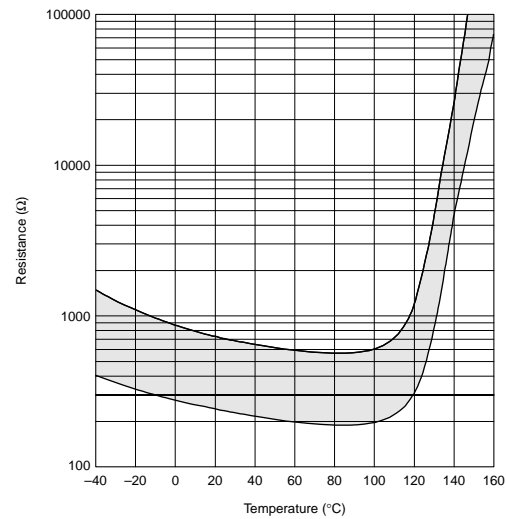

Continued on the following page.

⚠Note • Please read rating and ⚠CAUTION (for storage, operating, rating, soldering, mounting and handling) in this catalog to prevent smoking and/or burning, etc.
 • This catalog has only typical specifications because there is no space for detailed specifications. Therefore, please review our product specifications or consult the approval sheet for product specifications before ordering.

↳ Continued from the preceding page.

■ Resistance - Temperature Characteristics Range (Ref. Only)

PRF18BA471QS5RB

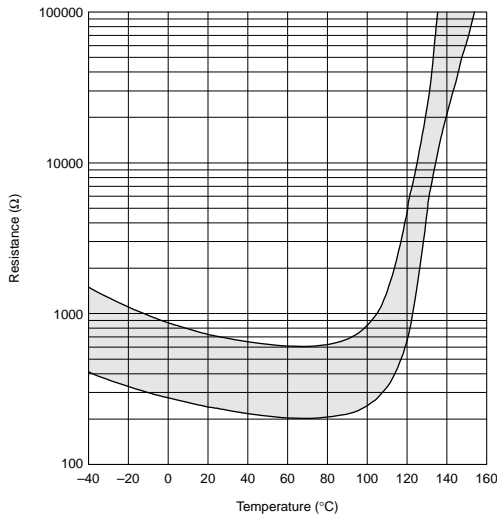

PRF18BB471QS5RB

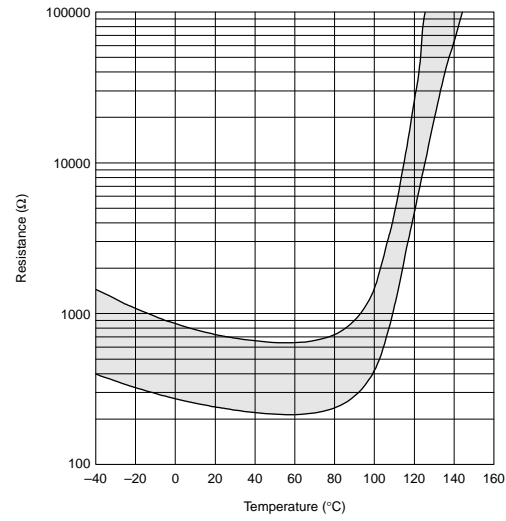

PRF18BC471QS5RB

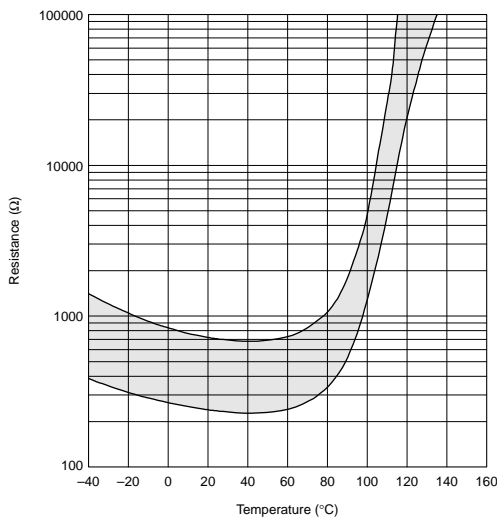

PRF18BD471QS5RB

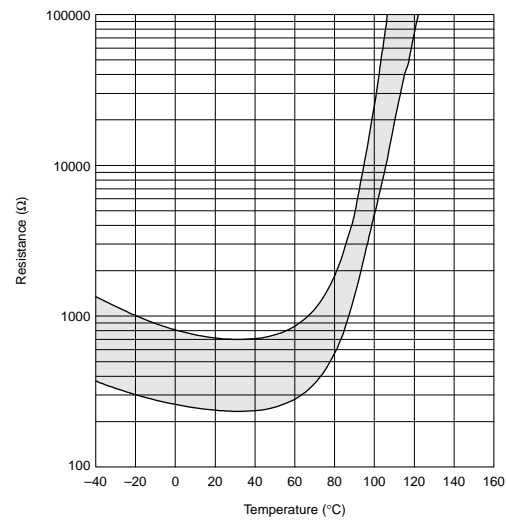

PRF18BE471QS5RB

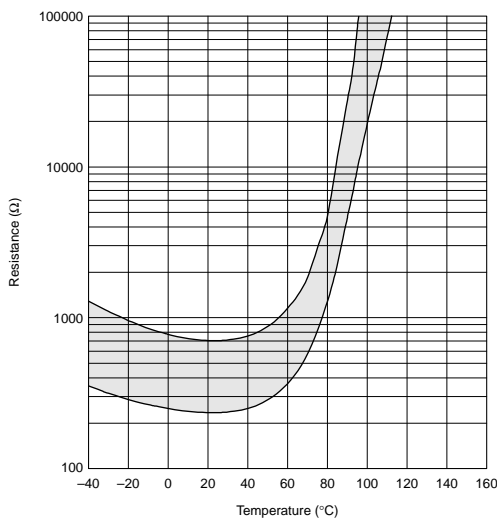

PRF18BF471QS5RB

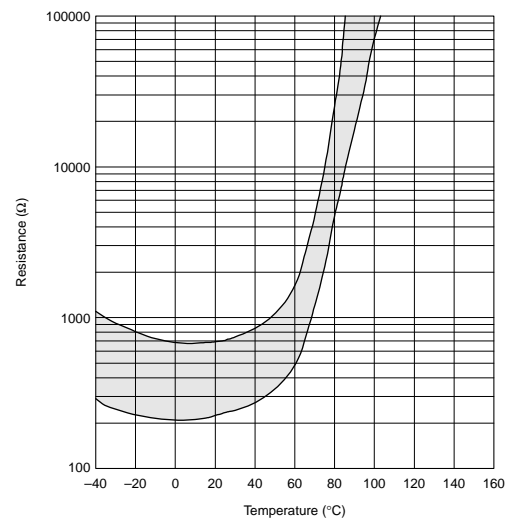

5

Continued on the following page. ↗



⚠Note • Please read rating and ⚠CAUTION (for storage, operating, rating, soldering, mounting and handling) in this catalog to prevent smoking and/or burning, etc.
 • This catalog has only typical specifications because there is no space for detailed specifications. Therefore, please review our product specifications or consult the approval sheet for product specifications before ordering.

☞ Continued from the preceding page.

■ Resistance - Temperature Characteristics Range (Ref. Only)

PRF18BG471QS5RB

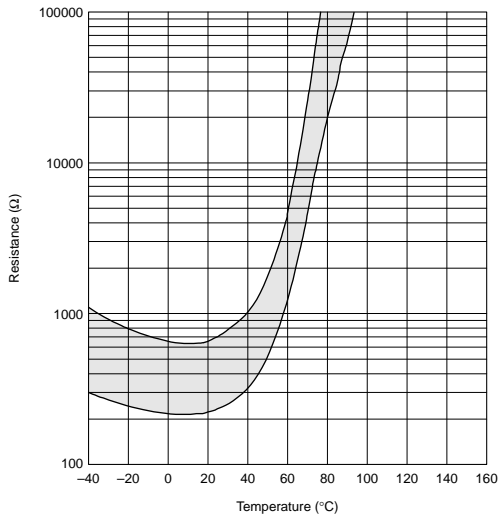

■ Resistance - Temperature Characteristics Range (Ref. Only) Tight Tolerance Type

PRF18BB471RS5RB

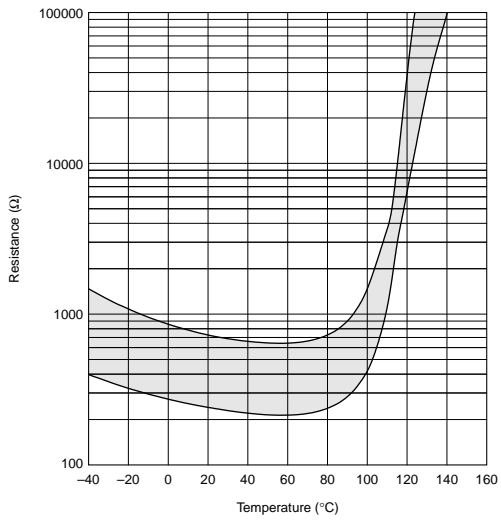

PRF18BC471RS5RB

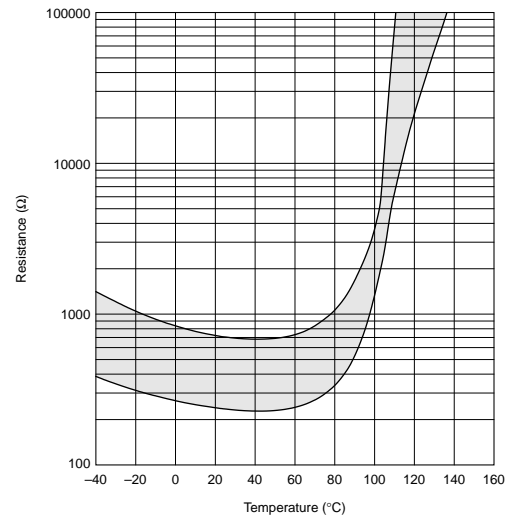

PRF18BD471RS5RB

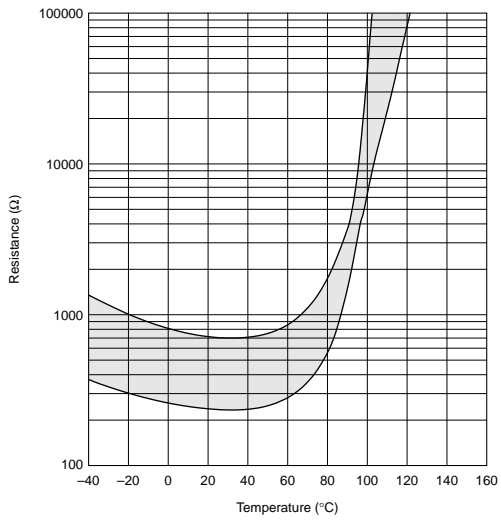

PRF18BE471RS5RB

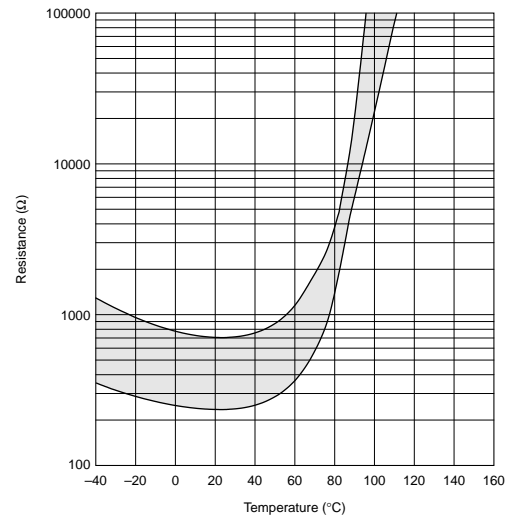

5

Continued on the following page. ☞

⚠Note • Please read rating and ⚠CAUTION (for storage, operating, rating, soldering, mounting and handling) in this catalog to prevent smoking and/or burning, etc.
• This catalog has only typical specifications because there is no space for detailed specifications. Therefore, please review our product specifications or consult the approval sheet for product specifications before ordering.

☒ Continued from the preceding page.

■ Resistance - Temperature Characteristics Range (Ref. Only) Tight Tolerance Type

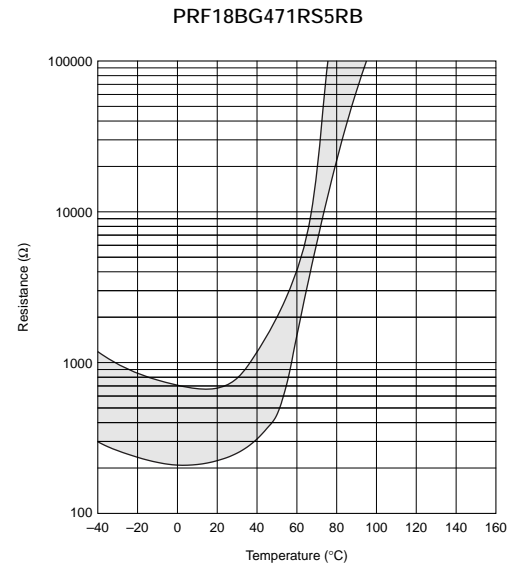
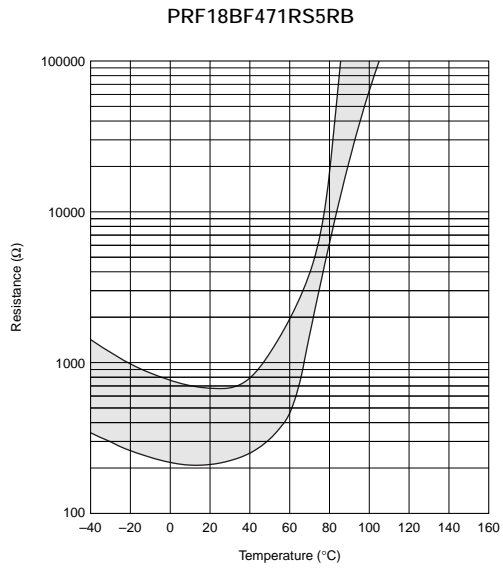

Chip Type of POSISTOR® for Overheat Sensing Specifications and Test Methods

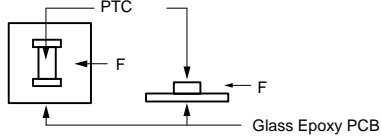
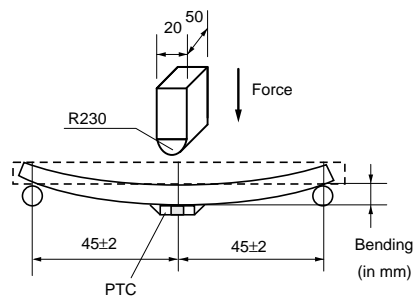
No.	Item	Rating Value	Method of Examination
1	Resistance Value (at 25°C)	The resistance value should be within the specified tolerance.	After applying maximum operating voltage for 3 minutes and leaving for 2 hours at 25°C, measure by applying voltage of less than 1.5VDC (by a direct current of less than 10mA).
2	Adhesive Strength	There is no sign of electrode detachment.	EIAJ ET-7403 term 9 Prepare soldered PTC to PCB *1 and add the force of 5.0N in the direction shown below. (PTC=POSISTOR®) 
3	Vibration Resistance	There is no abnormal appearance after the test. Resistance change is less than ±20%. *2	Solder PTC to PCB *1 Vibration: 10-2000-10Hz (20 minutes) Max. Amplitude: 3.0mm Vibrate for 4 hours in each of 3 mutually perpendicular planes for a total of 12 hours. This test condition is according to "MIL-STD-202G Method 204D."
4	Resistance to Bending of Substance	There is no abnormal appearance after the test. Resistance change is less than ±20%. *2	Solder PTC on Test Board *1, and apply force on back side of Test Board shown below: Bending Speed: 1.0mm/s Bending Strength: 2.0mm Hold Time: 5±1 seconds Board Dimension: 100x40x1.6t mm Board Material: Glass Epoxy 
5	Solderability	Min. 95% electrode is covered with new solder. Resistance change is less than ±20%. *2	• Solder Temp.: 230±5°C • Solder: Sn63%/Pb37% (or 60%/40%) • Soaking Time: 3±0.3 secs. • Soaking Position: Until a whole electrode is soaked. This test condition is according to "IEC 60068-2-58 (2004)."
6	Soldering Heat Resistance	There is no abnormal appearance after the test. Resistance change is less than ±20%. *2	• Solder Temp.: 260±5°C • Solder: Sn63%/Pb37% (or 60%/40%) • Flux: Containing less than 0.2wt% of chlorine. • Soaking Time: 10±1 secs. • Soaking Position: Until a whole electrode is soaked. • Preheating: 150±5°C 3 mins This test condition is according to "IEC 60068-2-58 (2004)."

5

*1 Above-mentioned soldering is done under the following conditions at our site.

- Glass-epoxy PC board
- Standard land dimension
- Standard solder paste
- Standard solder profile

Above conditions are defined in Notice.

*2 Measure resistance after the test by applying voltage of less than 1.5VDC by a direct current of less than 10mA after product is left at 25±2°C for 2 hours.

Continued on the following page. 

Chip Type of POSISTOR[®] for Overheat Sensing Specifications and Test Methods

Continued from the preceding page.

No.	Item	Rating Value	Method of Examination									
7	Dry Heat Resistance	There is no abnormal appearance after the test. Resistance change is less than $\pm 20\%$. *2 <Tight Tolerance Type> Sensing temp. change is less than $\pm 1^\circ\text{C}$.	Solder PTC to PCB *1 $+150\pm 3^\circ\text{C}$ leave for 1000 ± 12 hours									
8	Cold Resistance		Solder PTC to PCB $-40\pm 3^\circ\text{C}$ leave for 1000 ± 12 hours									
9	Damp Heat Resistance		Solder PTC to PCB *1 $+85\pm 3^\circ\text{C}$ 80-85%RH leave for 1000 ± 12 hours									
10	Thermal Shock 1 *3		Solder PTC to PCB *1 Test Cycle: 300 cycles <table border="1"> <thead> <tr> <th>Step</th> <th>Temp. ($^\circ\text{C}$)</th> <th>Time (minute)</th> </tr> </thead> <tbody> <tr> <td>1</td> <td>$-55+0, -3$</td> <td>30</td> </tr> <tr> <td>2</td> <td>$+150+3, -0$</td> <td>30</td> </tr> </tbody> </table>	Step	Temp. ($^\circ\text{C}$)	Time (minute)	1	$-55+0, -3$	30	2	$+150+3, -0$	30
Step	Temp. ($^\circ\text{C}$)		Time (minute)									
1	$-55+0, -3$		30									
2	$+150+3, -0$	30										
11	Thermal Shock 2 *3	Solder PTC to PCB *1 Test Cycle: 1000 cycles <table border="1"> <thead> <tr> <th>Step</th> <th>Temp. ($^\circ\text{C}$)</th> <th>Time (minute)</th> </tr> </thead> <tbody> <tr> <td>1</td> <td>$-55+0, -3$</td> <td>30</td> </tr> <tr> <td>2</td> <td>$+125+3, -0$</td> <td>30</td> </tr> </tbody> </table>	Step	Temp. ($^\circ\text{C}$)	Time (minute)	1	$-55+0, -3$	30	2	$+125+3, -0$	30	
Step	Temp. ($^\circ\text{C}$)	Time (minute)										
1	$-55+0, -3$	30										
2	$+125+3, -0$	30										
12	High Temperature Humidity Load	Solder PTC to PCB *1 $85\pm 3^\circ\text{C}$, 80-85%RH (in air), load max. operating voltage for 1000 ± 12 hours										
13	High Temperature Load	Solder PTC to PCB *1 $85\pm 3^\circ\text{C}$ (in air), load max. operating voltage for 1000 ± 12 hours.										

*1 Above-mentioned soldering is done under the following conditions at our site.

- Glass-epoxy PC board
- Standard land dimension
- Standard solder paste
- Standard solder profile

Above conditions are defined in Notice.

*2 Measure resistance after the test by applying voltage of less than 1.5VDC by a direct current of less than 10mA after product is left at $25\pm 2^\circ\text{C}$ for 2 hours.

*3 We cannot guarantee the resistance change in Thermal Shock (No.10, 11) in a case of defective mounting.

NTC/PTC Thermistors for Automotive



PTC Thermistor (POSISTOR®) for Overcurrent Protection Chip Type 0805 (2012) Size

Overcurrent Protection device with resettable function suitable for current limiting resistor.

This product is a chip type PTC thermistor for overcurrent protection that is suitable for the following.

- Countermeasure for short circuit testing
- Current limiting resistor

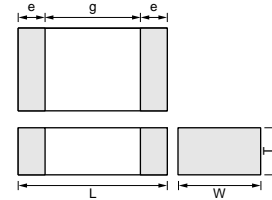

Part Number	Dimensions (mm)				
	L	W	T	e	g
PRG21_RA	2.0±0.2	1.25±0.2	0.9±0.2	0.2 min.	0.5 min.
PRG21_RK	2.0±0.2	1.25±0.2	1.25±0.2	0.2 min.	0.5 min.

■ Features

1. Rapid operation to protect the circuit in an overcurrent condition abnormality such as a short circuit.
By removing the overcurrent condition, these products automatically return to the initial condition and can be used repeatedly.
2. Suitable for countermeasure to short circuit test in safety standard.
3. Stable resistance after operation due to ceramic PTC.
4. Similar size (0603 size) is possible due to the large capacity for electric power.
5. Possible to use these products as current limiting resistors with overcurrent protection functions
6. The SMD type's small size and light weight are helpful in miniaturizing the circuit.

6

Part Number	Max. Voltage (V)	Hold Current (at +105°C) (mA)	Hold Current (at +85°C) (mA)	Hold Current (at +25°C) (mA)	Trip Current (at +25°C) (mA)	Trip Current (at -40°C) (mA)	Max. Current (mA)	Resistance (at +25°C) (ohm)
PRG21AR4R7MS2RA	16	75	110	205	390	525	4260	4.7 ±20%
PRG21AR220MS1RK	16	25	45	75	195	250	900	22 ±20%
PRG21AR420MS1RA	20	15	25	54	102	130	590	42 ±20%

Maximum Current shows typical capacities at which the transformer can be used.
 Operating Temperature Range: -40°C to +105°C

■ Standard Land Pattern Dimensions

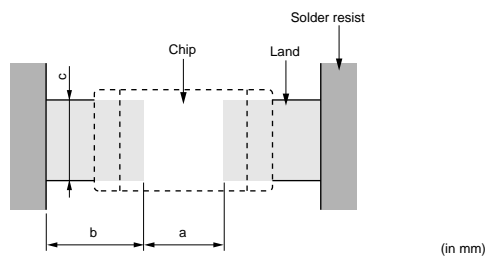

Part Number	Soldering Methods	Dimensions (mm)			
		Chip (L×W)	a	b	c
PRG21	Reflow Soldering	2.0×1.25	1.0-1.2	0.5-0.7	1.0-1.2

■ Protective Threshold Current Range

PRG21AR4R7MS2RA

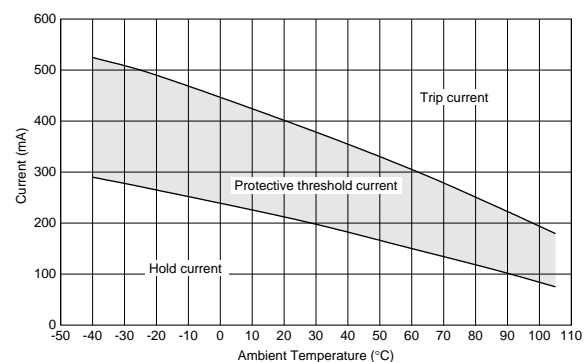

Continued on the following page. ↗



△Note • Please read rating and △CAUTION (for storage, operating, rating, soldering, mounting and handling) in this catalog to prevent smoking and/or burning, etc.
 • This catalog has only typical specifications because there is no space for detailed specifications. Therefore, please review our product specifications or consult the approval sheet for product specifications before ordering.

Continued from the preceding page.

■ Protective Threshold Current Range

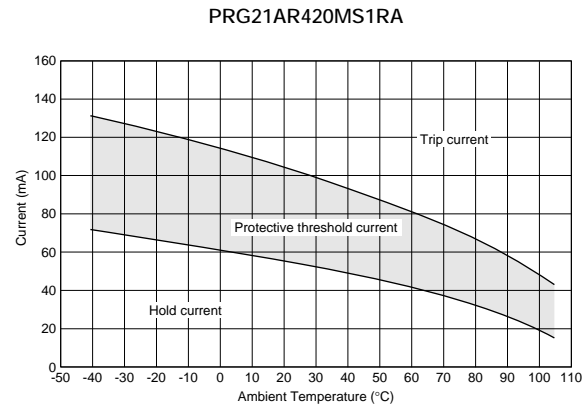
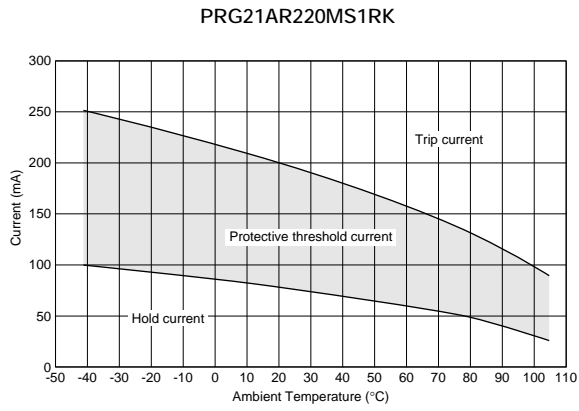

■ Operating Time (Typical Curve)

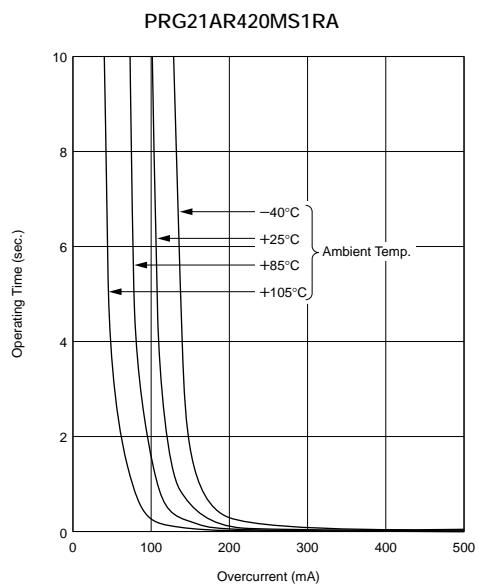
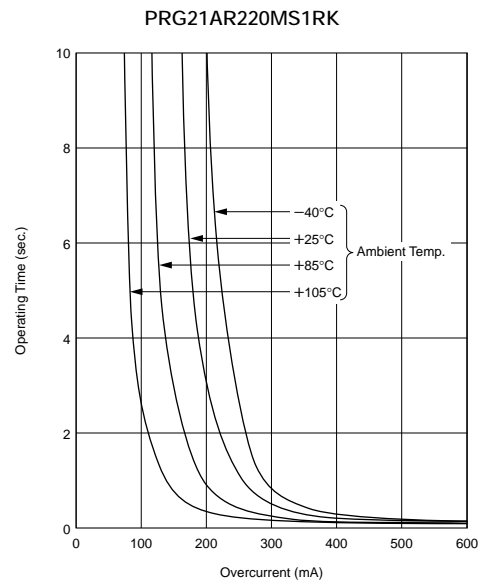
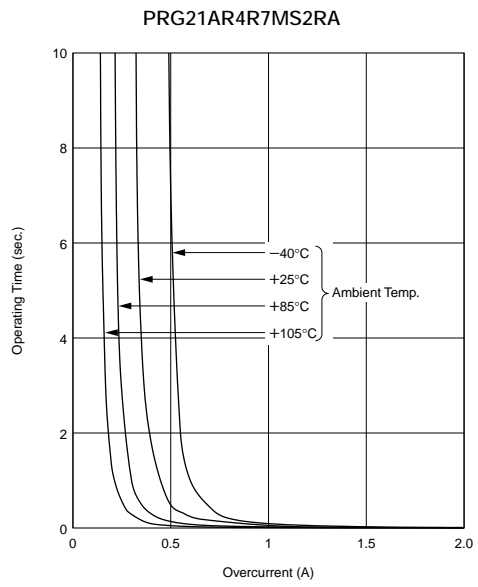

Chip Type of POSISTOR[®] for Overcurrent Protection Specifications and Test Methods

■ PRG21AR4R7M

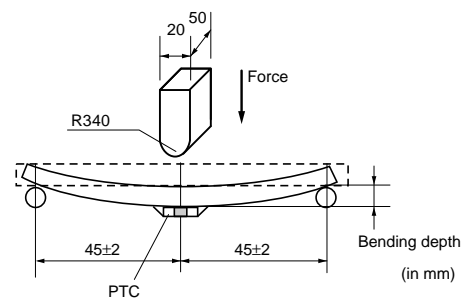
No.	Item	Rating Value	Mention of Examination
1	Operating Temp. Range	-40 to +105°C	Temperature range that permit to apply max. voltage to the Posistor [®] .
2	Storage Temp. Range	-40 to +125°C	Temperature range that permit to leaving without applying power to the Posistor [®] .
3	Resistance Value at 25°C	Within the specified range.	It is measured by below flow. 1) Applied max. voltage for 3min. 2) Storage 2hrs in room temperature 3) Measured by four-terminal method with less than 10mA (DC 0.1V)
4	Shear Test	<ul style="list-style-type: none"> • Resistance (R25) change: Less than ±20% *1 • Appearance: No defects or abnormalities 	Reference standard: IEC 60068-2-21 (1999) <ul style="list-style-type: none"> • Solder PTC to PCB *2 • Test board: Grass-Epoxy test board (FR-4) with our standard land size • Pushing force: 10N • Keep time: 10±1 sec.
5	Vibration		Reference standard: IEC 60068-2-6 (1995) <ul style="list-style-type: none"> • Solder PTC to PCB *2 • Frequency range: 10 to 55Hz • Amplitude: 1.5mm • Sweep rate: 1 octave/min. • Direction: X-Y-Z (3 direction) • 24 cycles in each axis
6	Bending Test		Reference standard: IEC 60068-2-21 (1999) <ul style="list-style-type: none"> • Solder PTC to PCB *2 • Board dimension: 100×40×1.6mm (Grass epoxy board) • Bending speed: 1.0mm/s • Bending depth: 1.5mm • Keep time: 5±1 sec. 
7	Solderability	Wetting of soldering area: ≥75%	Reference standard: IEC 60068-2-58 (2004) <ul style="list-style-type: none"> • Solder: Sn-3.0Ag-0.5Cu • Solder temp.: 245±5°C • Immersion time: 3±0.3s

*1: The resistance value after the test is measured by 4-terminal method with less than 10mA (DC0.1V), after storage in 25±2°C for 2hrs.

*2: Above-mentioned soldering is done following condition at our side.

- Glass-epoxy PC board
- Standard land dimension
- Standard solder paste
- Standard solder profile

Above conditions are defined in Notice.

Continued on the following page. 

Chip Type of POSISTOR[®] for Overcurrent Protection Specifications and Test Methods

Continued from the preceding page.

No.	Item	Rating Value	Mention of Examination									
8	Resistance to Soldering Heat		Reference standard: IEC 60068-2-58 (2004) [Reflow Method] • Solder: Sn-3.0Ag-0.5Cu • Preheat: +150 to +180°C, 120±5s • Peak temp.: 260±5°C • Soldering time: >220°C, 60 to 90s • Reflow cycle: 2 times • Test board: Glass-Epoxy test board (FR-4) with our standard land size									
9	High Temperature Storage		Reference standard: IEC 60068-2-2 (2007) • Solder PTC to PCB *2 • +125±2°C • 1000+48/-0 hrs.									
10	Low Temperature Storage		Reference standard: IEC 60068-2-1 (2007) • Solder PTC to PCB *2 • -40±3°C • 1000+48/-0 hrs.									
11	Damp Heat, Steady State	• Resistance (R25) change: Less than ±20% *1 • Appearance: No defects or abnormalities	Reference standard: IEC 60068-2-67 (1995) • Solder PTC to PCB *2 • +85±2°C, 85±5%RH • 1000+48/-0 hrs.									
12	Thermal Shock *3		Reference standard: IEC 60068-2-14 (2009) [Test Na] • Solder PTC to PCB *2 • Transport time: <10 sec. • Test condition: See below table <table border="1" style="margin-left: 20px;"> <thead> <tr> <th>Step</th> <th>Condition</th> <th>Soaking Time</th> </tr> </thead> <tbody> <tr> <td>1</td> <td>-40±3°C</td> <td>30 min.</td> </tr> <tr> <td>2</td> <td>+125±2°C</td> <td>30 min.</td> </tr> </tbody> </table> • Test cycle: 1000cycles	Step	Condition	Soaking Time	1	-40±3°C	30 min.	2	+125±2°C	30 min.
Step	Condition	Soaking Time										
1	-40±3°C	30 min.										
2	+125±2°C	30 min.										
13	High Temperature Load		Reference standard: IEC 60068-2-2 (2007) • Solder PTC to PCB *2 • +105±2°C • Applied max. voltage • 1000+48/-0 hrs.									
14	Damp Heat Load		Reference standard: IEC 60068-2-67 (1995) • Solder PTC to PCB *2 • +85±2°C, 85±5%RH • Applied max. voltage • 1000+48/-0 hrs.									

*1: The resistance value after the test is measured by 4-terminal method with less than 10mA (DC0.1V), after storage in 25±2°C for 2hrs.

*2: Above-mentioned soldering is done following condition at our side.

- Glass-epoxy PC board
- Standard land dimension
- Standard solder paste
- Standard solder profile

Above conditions are defined in Notice.

*3: We cannot guarantee the resistance change in Thermal Shock in a case of defective mounting.

Chip Type of POSISTOR[®] for Overcurrent Protection Specifications and Test Methods

■ PRG21AR220/420M

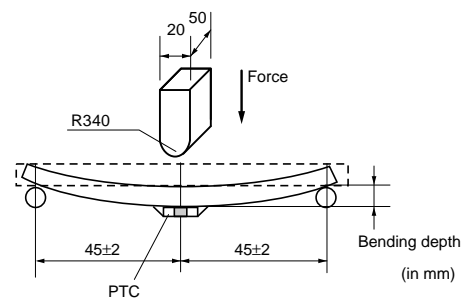
No.	Item	Rating Value	Mention of Examination
1	Operating Temp. Range	-40 to +105°C	Temperature range that permit to apply max. voltage to the Posistor [®] .
2	Storage Temp. Range	-40 to +125°C	Temperature range that permit to leaving without applying power to the Posistor [®] .
3	Resistance Value at 25°C	Within the specified range.	It is measured by below flow. 1) Applied max. voltage for 3min. 2) Storage 2hrs in room temperature 3) Measured by four-terminal method with less than 10mA (DC 1.5V)
4	Shear Test	<ul style="list-style-type: none"> • Resistance (R25) change: Less than $\pm 20\%$ *1 • Appearance: No defects or abnormalities 	Reference standard: IEC 60068-2-21 (1999) <ul style="list-style-type: none"> • Solder PTC to PCB *2 • Test board: Glass-Epoxy test board (FR-4) with our standard land size • Pushing force: 5N • Keep time: 10+/-1 sec.
5	Vibration		Reference standard: MIL-STD-202G Method 204D (2002) <ul style="list-style-type: none"> • Solder PTC to PCB *2 • Frequency range: 10 to 2kHz • Amplitude: 3.0mm • Sweep rate: 1 octave/min. • Direction: X-Y-Z (3 direction) • 10 cycles in each axis
6	Bending Test		Reference standard: IEC 60068-2-21 (1999) <ul style="list-style-type: none"> • Solder PTC to PCB *2 Board dimension: 100×40×1.6mm (Glass epoxy board) • Bending speed: 1.0mm/s • Bending depth: 2.0mm • Keep time: 5±1 sec. 
7	Solderability	Wetting of soldering area: $\geq 75\%$	Reference standard: IEC 60068-2-58 (2004) <ul style="list-style-type: none"> • Solder: Sn-3.0Ag-0.5Cu • Solder temp.: 245±5°C • Immersion time: 3±0.3s

*1: The resistance value after the test is measured by 4-terminal method with less than 10mA (DC0.1V), after storage in 25±2°C for 2hrs.

*2: Above-mentioned soldering is done following condition at our side.

- Glass-epoxy PC board
- Standard land dimension
- Standard solder paste
- Standard solder profile

Above conditions are defined in Notice.

Continued on the following page. 

Chip Type of POSISTOR[®] for Overcurrent Protection Specifications and Test Methods

Continued from the preceding page.

No.	Item	Rating Value	Mention of Examination									
8	Resistance to Soldering Heat		Reference standard: IEC 60068-2-58 (2004) [Reflow Method] • Solder: Sn-3.0Ag-0.5Cu • Preheat: +150 to +180°C, 120±5s • Peak temp.: 260±5°C • Soldering time: >220°C, 60 to 90s • Reflow cycle: 2 times • Test board: Grass-Epoxy test board (FR-4) with our standard land size									
9	High Temperature Storage		Reference standard: IEC 60068-2-2 (2007) • Solder PTC to PCB *2 • +125±2°C • 1000+48/-0 hrs.									
10	Low Temperature Storage		Reference standard: IEC 60068-2-1 (2007) • Solder PTC to PCB *2 • -40±3°C • 1000+48/-0 hrs.									
11	Damp Heat, Steady State	• Resistance (R25) change: Less than ±20% *1 • Appearance: No defects or abnormalities	Reference standard: IEC 60068-2-67 (1995) • Solder PTC to PCB *2 • +85±2°C, 85±5%RH • 1000+48/-0 hrs.									
12	Thermal Shock *3		Reference standard: IEC 60068-2-14 (2009) [Test Na] • Solder PTC to PCB *2 • Transport time: <10 sec. • Test condition: See below table <table border="1" style="margin-left: 20px;"> <thead> <tr> <th>Step</th> <th>Condition</th> <th>Soaking Time</th> </tr> </thead> <tbody> <tr> <td>1</td> <td>-55±3°C</td> <td>30 min.</td> </tr> <tr> <td>2</td> <td>+125±2°C</td> <td>30 min.</td> </tr> </tbody> </table> • Test cycle: 1000 cycles	Step	Condition	Soaking Time	1	-55±3°C	30 min.	2	+125±2°C	30 min.
Step	Condition	Soaking Time										
1	-55±3°C	30 min.										
2	+125±2°C	30 min.										
13	High Temperature Load		Reference standard: IEC 60068-2-2 (2007) • Solder PTC to PCB *2 • +105+/-2°C • Applied max. voltage • 1000+48/-0 hrs.									
14	Damp Heat Load		Reference standard: IEC 60068-2-67 (1995) • Solder PTC to PCB *2 • +85±2°C, 85±5%RH • Applied max. voltage • 1000+48/-0 hrs.									

*1: The resistance value after the test is measured by 4-terminal method with less than 10mA (DC0.1V), after storage in 25±2°C for 2hrs.

*2: Above-mentioned soldering is done following condition at our side.

- Glass-epoxy PC board
- Standard land dimension
- Standard solder paste
- Standard solder profile

Above conditions are defined in Notice.

*3: We cannot guarantee the resistance change in Thermal Shock in a case of defective mounting.

POSISTOR[®] Chip Type ⚠Caution/Notice

■ ⚠Caution (Storage and Operating Conditions)

This product is designed for application in an ordinary environment (normal room temperature, humidity and atmospheric pressure). Do not use under the following conditions because all of these factors can deteriorate the characteristics or cause product failure and burn-out.

1. Corrosive gas or deoxidizing gas (Chlorine gas, Hydrogen sulfide gas, Ammonia gas, Sulfuric acid gas, Nitric oxide gas, etc.)
2. Volatile or flammable gas
3. Dusty conditions
4. Under vacuum, or under high or low pressure
5. Wet or humid conditions
6. Places with salt water, oils, chemical liquids or organic solvents
7. Strong vibrations
8. Other places where similar hazardous conditions exist

■ ⚠Caution (Other)

Be sure to provide an appropriate fail-safe function on your product to prevent secondary damage that may be caused by the abnormal function or the failure of our product.

■ Notice (Storage and Operating Conditions)

To keep solderability of product from declining, the following storage conditions are recommended.

1. Storage condition:
Temperature -10 to +40°C
Humidity less than 75%RH (not dewing condition)
2. Storage term:
Use this product within 6 months after delivery by first-in and first-out stocking system.
3. Handling after unpacking:
After unpacking, promptly reseal this product or store it in a sealed container with a drying agent.
4. Storage place:
Do not store this product in corrosive gas (Sulfuric acid, Chlorine, etc.) or in direct sunlight.

POSISTOR® Chip Type ⚠ Caution/Notice

■ Notice (Soldering and Mounting) PRF18 Series

1. Solder and Flux

(1) Solder Paste

(a) Flow Soldering: Use Sn:Pb=60:40wt%, Sn:Pb=63:37wt%, Sn:Ag:Cu=96.5:3.0:0.5wt% or equivalent type of solder.

(b) Reflow Soldering: Use Sn:Pb=60:40wt%, Sn:Pb=63:37wt%, Sn:Ag:Cu=96.5:3.0:0.5wt% or equivalent type of solder paste.

For your reference, we are using "63Sn/37Pb RMA9086 90-3-M18," manufactured by Alpha Metals Japan Ltd., "96.5Sn/3.0Ag/0.5Cu M705-GRN360-K2-V," manufactured by Senju Metal Industry Co., Ltd. for any internal tests of this product.

(2) Flux

Use rosin type flux in the soldering process. If the flux below is used, some problems might be caused in the product characteristics and reliability. Please do not use these types of flux.

- Strong acidic flux (with halide content exceeding 0.2wt%).
- Water-soluble flux (*Water-soluble flux can be defined as non-rosin type flux including wash-type flux and non-wash-type flux.)

2. Cleaning Conditions and Drying

To remove the flux after soldering, observe the following points in order to avoid deterioration of the characteristics or any change to the external electrodes' quality.

(1) Cleaning Conditions

Solvent	Dipping Cleaning	Ultrasonic Cleaning
2-propanol	Less than 5 minutes at room temp. or Less than 2 minutes at 40°C max.	Less than 1 minute 20W/L Frequency of several 10kHz to 100kHz.

A sufficient cleaning should be applied to remove flux completely.

(2) Drying

After cleaning, promptly dry this product.

3. Soldering Conditions

In your mounting process, observe the following points in order to avoid deterioration of the characteristics or destruction of this product. The mounting quality of this product may also be affected by the mounting conditions, shown in the points below.

(1) Printing Conditions of Solder Paste

- (a) Recommended thickness of solder paste printing should be from 0.15 to 0.20mm.
- (b) After soldering, the solder fillet should be a height from 0.2 mm to the thickness of this product (see the figure at right).
- (c) Too much solder result in excessive mechanical stress on this product. Such stress may cause cracking or other mechanical damage. Also, it can destroy the electrical performance of this product.

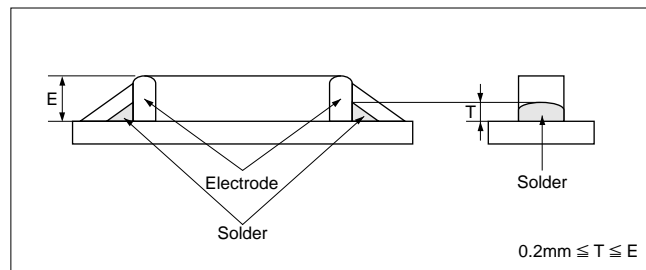

Continued on the following page. ↗

POSISTOR[®] Chip Type ⚠Caution/Notice

☒ Continued from the preceding page.

(2) Adhesive Application and Curing

- (a) If insufficient adhesive is applied, or if the adhesive is not sufficiently hardened, this product may have a loose contact with the land, during flow soldering.
- (b) Too low viscosity of adhesive causes this product to slip on the board, after mounting.

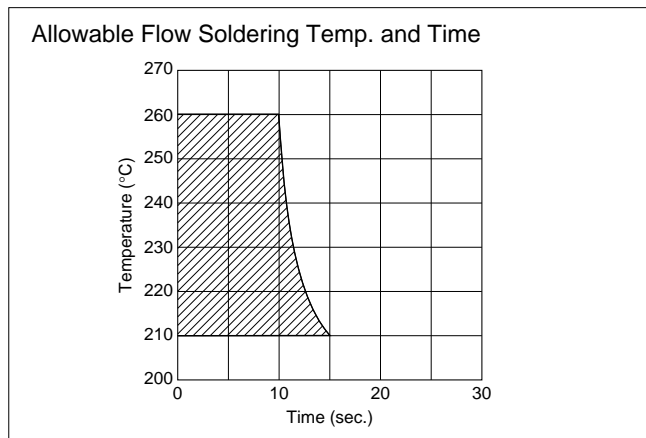

(3) Allowable Soldering Temperature and Time

- (a) Solder within the temperature and time combinations, indicated by the slanted lines in the following graphs.
- (b) Excessive soldering conditions may cause dissolution of metallization or deterioration of solder-wetting on the external electrode.
- (c) In the case of repeated soldering, the accumulated soldering time should be within the range shown in the figures below. (For example, Reflow peak temperature: 260°C, twice → The accumulated soldering time at 260°C is within 30sec.)

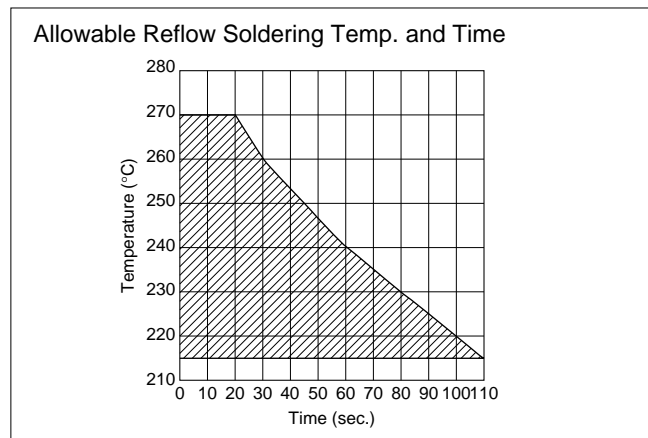

(4) Recommendable Temperature Profile for Soldering

- (a) Insufficient preheating may cause a crack on the ceramic body. The difference between preheating temperature and maximum temperature in the profile should be 100°C.
- (b) Rapid cooling by dipping in solvent or by other means is not recommended.

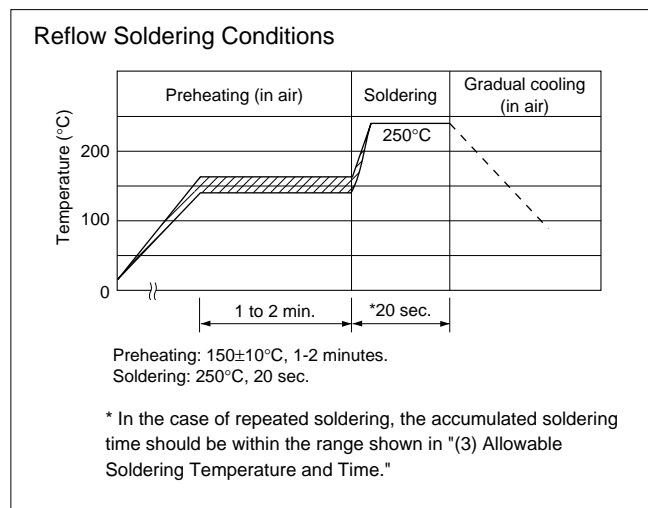
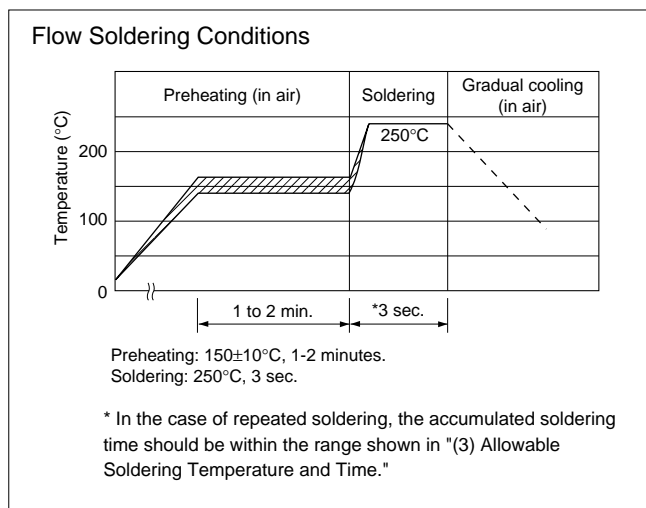

- (5) There may be a risk of unexpected failures (tombstone, insufficient solder-wetting, etc.) in the mounting process caused by mounting conditions. Please make sure that this product is correctly mounted under the specified mounting conditions.

POSISTOR® Chip Type ⚠Caution/Notice

■ Notice (Soldering and Mounting) PRG21AR4R7M

1. Solder and Flux

(1) Solder Paste

Use solder paste Sn:Pb=63:37wt%.
 For your reference, we are using
 63Sn/37Pb RMA9086 90-3-M18,
 manufactured by Alpha Metals Japan Ltd.
 96.5Sn/3.0Ag/0.5Cu M705-GRN360-K2-V,
 manufactured by Senju Metal Industry Co., LTD for any
 internal tests of this product.

(2) Flux

Use rosin type flux in the soldering process.
 If the flux below is used, some problems might be
 caused in the product characteristics and reliability.
 Please do not use these types of flux.
 • Strong acidic flux (with halide content exceeding
 0.2wt%).
 • Water-soluble flux
 (*Water-soluble flux can be defined as non-rosin type
 flux including wash-type flux and non-wash-type flux.)

2. Cleaning Conditions

To remove the flux after soldering, observe the following
 points in order to avoid deterioration of the characteristics
 or any change to the external electrodes' quality.

Solvent	Dipping Cleaning	Ultrasonic Cleaning	Drying
2-propanol	Less than 5 minutes at room temp. or Less than 2 minutes at 40°C max.	Less than 1 minute 20W/L Frequency of several 10kHz to 100kHz.	After cleaning, promptly dry this product.

A sufficient cleaning should be applied to remove flux completely.

3. Soldering Conditions

In your mounting process, observe the following points in
 order to avoid deterioration of the characteristics or
 destruction of this product. The mounting quality of this
 product may also be affected by the mounting conditions,
 shown in the points below.

This product is for reflow soldering only. Flow soldering
 should not be allowed.

(1) Printing Conditions of Solder Paste

- (a) Standard thickness of solder paste printing should
 be from 0.15 to 0.20 mm.
- (b) After soldering, the solder fillet should be a height
 from 0.20 mm to the thickness of this product (see the
 figure at right).
- (c) Too much solder result in excessive mechanical
 stress on this product. Such stress may cause
 cracking or other mechanical damage. Also, it can
 destroy the electrical performance of this product.

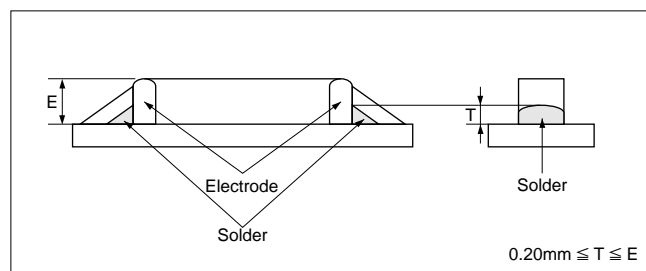

Continued on the following page. ↗

POSISTOR[®] Chip Type ⚠Caution/Notice

☒ Continued from the preceding page.

(2) Reflow soldering conditions

The following figure and table show our recommended reflow profile.

- (a) Insufficient preheating may cause a crack on ceramic body. The temperature difference between preheat and peak should be control within 100°C to prevent this.
- (b) Excessive soldering conditions may cause dissolution of metallization or deterioration of solder-wetting on the external electrode.
- (c) Rapid cooling by dipping in solvent or by other means is not recommended.
- (d) Please evaluate it on your condition if you will do mounting using not applying condition to the above-mentioned.

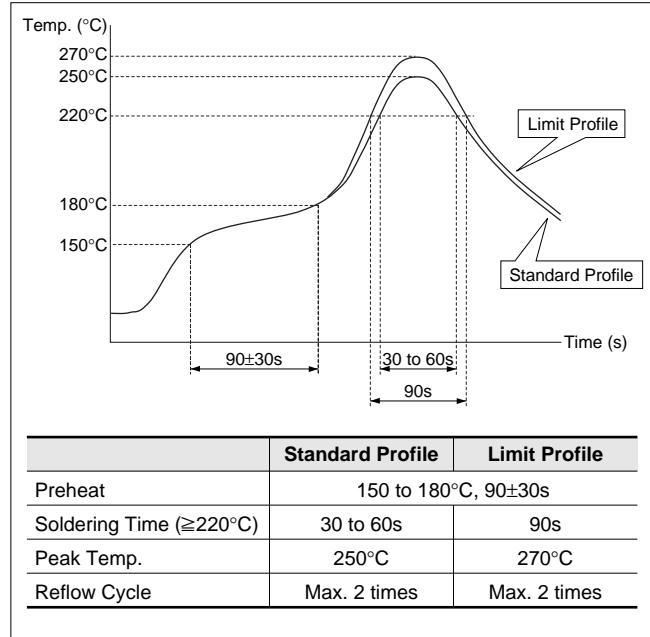

- (3) There may be a risk of unexpected failures (tombstone, insufficient solder-wetting, etc.) in the mounting process, caused by the mounting conditions. Please make sure that this product is correctly mounted under specified mounting conditions.

POSISTOR® Chip Type ⚠Caution/Notice

■ Notice (Soldering and Mounting) PRG21AR220/420M

1. Solder and Flux

(1) Solder Paste

Use solder paste Sn:Pb=63:37wt%.
 For your reference, we are using
 63Sn/37Pb RMA9086 90-3-M18,
 manufactured by Alpha Metals Japan Ltd.
 96.5Sn/3.0Ag/0.5Cu M705-GRN360-K2-V,
 manufactured by Senju Metal Industry Co., LTD for any
 internal tests of this product.

(2) Flux

Use rosin type flux in the soldering process.
 If the flux below is used, some problems might be
 caused in the product characteristics and reliability.
 Please do not use these types of flux.
 • Strong acidic flux (with halide content exceeding
 0.2wt%).
 • Water-soluble flux
 (*Water-soluble flux can be defined as non-rosin type
 flux including wash-type flux and non-wash-type flux.)

2. Cleaning Conditions

To remove the flux after soldering, observe the following
 points in order to avoid deterioration of the characteristics
 or any change to the external electrodes' quality.

Solvent	Dipping Cleaning	Ultrasonic Cleaning	Drying
2-propanol	Less than 5 minutes at room temp. or Less than 2 minutes at 40°C max.	Less than 1 minute 20W/L Frequency of several 10kHz to 100kHz.	After cleaning, promptly dry this product.

A sufficient cleaning should be applied to remove flux completely.

3. Soldering Conditions

In your mounting process, observe the following points in
 order to avoid deterioration of the characteristics or
 destruction of this product. The mounting quality of this
 product may also be affected by the mounting conditions,
 shown in the points below.

This product is for reflow soldering only. Flow soldering
 should not be allowed.

(1) Printing Conditions of Solder Paste

- (a) Standard thickness of solder paste printing should
 be from 0.15 to 0.20 mm.
- (b) After soldering, the solder fillet should be a height
 from 0.2 mm to the thickness of this product (see the
 figure at right).
- (c) Too much solder result in excessive mechanical
 stress to this product. Such stress may cause
 cracking or other mechanical damage. Also, it can
 destroy the electrical performance of this product.

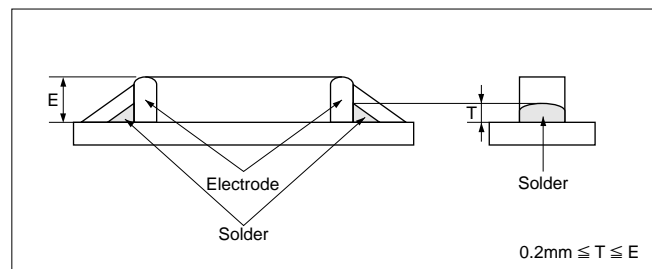

Continued on the following page. ↗

POSISTOR[®] Chip Type ⚠Caution/Notice

☐ Continued from the preceding page.

(2) Allowable Soldering Temperature and Time

- (a) Solder within the temperature and time combinations, indicated by the slanted lines in the graphs at right.
- (b) Excessive soldering conditions may cause dissolution of metallization or deterioration of solder-wetting on the external electrode.
- (c) In the case of repeated soldering, the accumulated soldering time should be within the range shown at right. (For example, Reflow peak temperature: 260°C, twice → The accumulated soldering time at 260°C is within 15sec.)

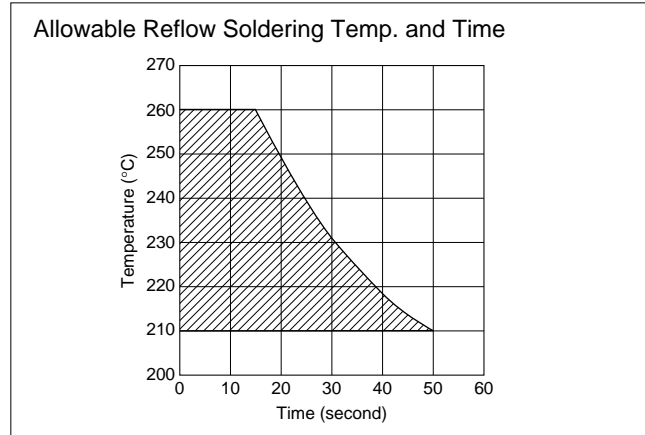

(3) Standard Temperature Profile for Soldering

- (a) Insufficient preheating may cause a crack on the ceramic body. The difference between preheating temperature and maximum temperature in the profile should be 100°C.
- (b) Rapid cooling by dipping in solvent or by other means is not recommended.

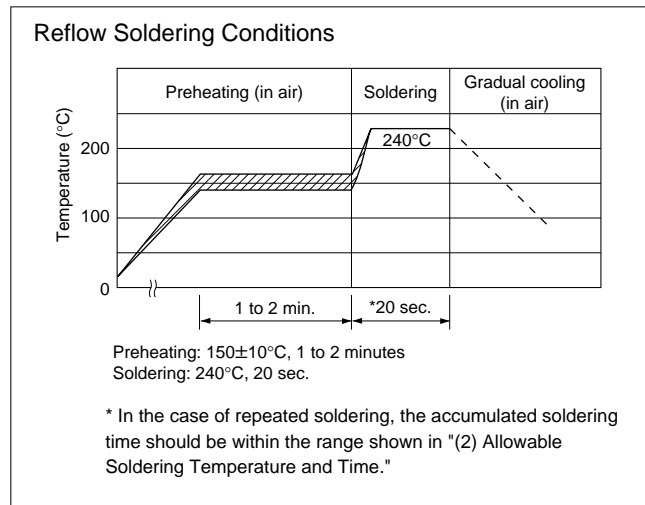

- (4) There may be a risk of unexpected failures (tombstone, insufficient solder-wetting, etc.) in the mounting process, caused by the mounting conditions. Please make sure that this product is correctly mounted under the specified mounting conditions.

POSISTOR[®] Chip Type ⚠ Caution/Notice

■ Notice (Handling)

1. Do not give this product a strong press-force or a mechanical shock, because such mechanical forces may cause cracking or chipping of this ceramic product.
2. Rapid cooling or heating during soldering is not recommended such treatment may destroy the element.
3. Resin coating
Please select a resin material with minimum hardness. The shrinkage of the resin at heat treatment should be much less in order not to apply much stress to the product.
4. Location on Printed Circuit Board (PC Board)
Choose a mounting position that minimizes the stress imposed on the chip during flexing or bending of the board.

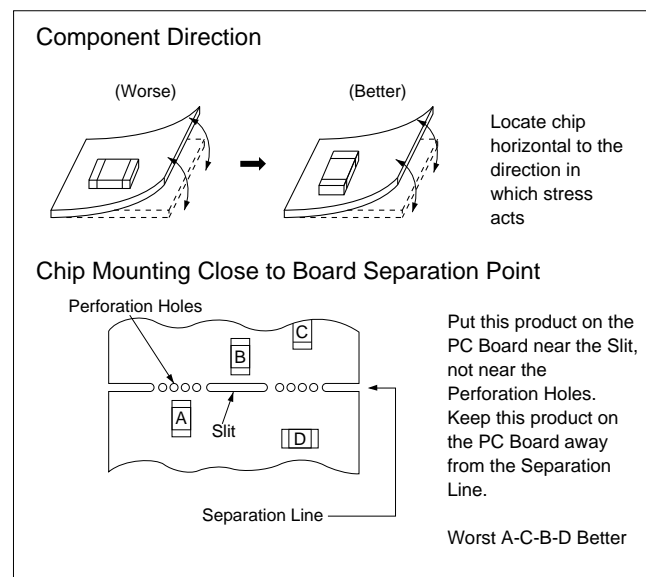

NTC/PTC Thermistors for Automotive



PTC Thermistor (POSISTOR®) for Overcurrent Protection Lead Type

16V Series

This low-voltage, low-resistance type "POSISTOR" is a circuit protector whose resistance value in normal operation is very low and in abnormal situations such as motor lock or short circuit, will be increased to restrain over current. This "POSISTOR" is most suitable for low-voltage circuits and motor protection for automotive grade applications.

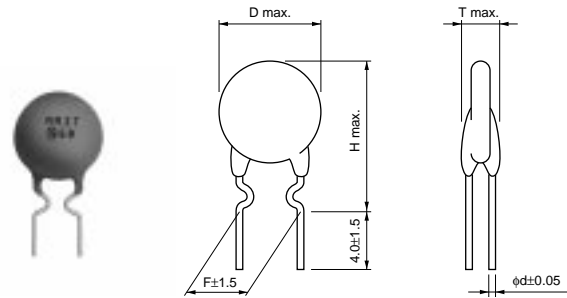

(in mm)

■ Features

1. Best suited to meet the requirements for power supply and motor protection. Error-free operation is assured by rush current.
2. Circuit is protected until current is turned off.
3. Restores the original low resistance value automatically once the overload is removed.
4. Non-contact design leads to long life and no noise.
Durable and strong against mechanical vibration and shock because it is a solid element.
5. Lead (Pb) is not contained in the terminations.

Part Number	Max. Voltage (V)	Hold Current (at +85°C) (mA)	Hold Current (at +25°C) (mA)	Trip Current (at +25°C) (mA)	Trip Current (at -30°C) (mA)	Max. Current (A)	Resistance (at +25°C) (ohm)	Body Diameter (D)(mm)	Thickness (T) (mm)	Height (H) (mm)	Lead Space (F)(mm)	Lead Diameter (phi d)(mm)
PTGL5SAR1R0M1B51B0	16	252	470	880	1095	2.0	1.0 ±20%	6.0	3.5	9.5	5.0	0.6
PTGL6SAR0R8M1B51B0	16	274	505	955	1193	3.0	0.8 ±20%	6.5	3.5	10.0	5.0	0.6
PTGL7SARR47M1B51B0	16	376	705	1310	1634	5.0	0.47 ±20%	7.5	3.5	12.0	5.0	0.6
PTGL9SARR33M1B51B0	16	466	875	1625	2026	7.0	0.33 ±20%	9.0	3.5	14.0	5.0	0.6
PTGLASARR27M1B51B0	16	545	1025	1900	2369	8.0	0.27 ±20%	10.1	3.5	15.0	5.0	0.6
PTGLCSAR0R2M1B51B0	16	692	1300	2410	3006	9.0	0.2 ±20%	11.3	3.5	16.0	5.0	0.6
PTGLESARR15M1B51B0	16	820	1545	2855	3561	10	0.15 ±20%	13.5	3.5	18.5	5.0	0.6

7

Maximum Current shows typical capacities at which the transformer can be used.
 Operating Temperature Range: -30°C to +85°C
 Taping type of part numbers with "A0" is available (except PTGLESARR15M1B51B0).

30-140V Series

New leaded type "POSISTOR" for overcurrent protection as automotive grade can be used with a wide temperature range. This product is suitable for short-protection and current limiting resistance on power supply equipment.

■ Features

1. Useful protective threshold current range with a wide temperature range.
2. Small fluctuation in the circuit due to resistance tolerance +/-10%.
3. Quick operating time due to small size compared with conventional products.
4. Best suited to meet the requirements of power supply and motor protector. Error-free operation is assured by rush current.
5. Circuit is protected until current is turned off.
6. Restores the original low resistance value automatically once the overload is removed.
7. Non-contact design leads to long life and no noise.
Durable and strong against mechanical vibration and shock because it is a solid element.
8. Lead (Pb) is not contained in the terminations.

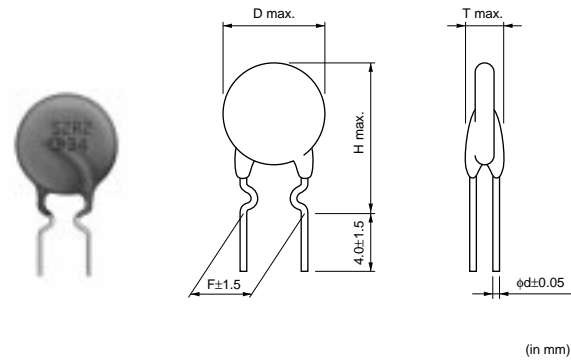

(in mm)

Part Number	Max. Voltage (V)	Hold Current (at +105°C) (mA)	Hold Current (at +85°C) (mA)	Hold Current (at +25°C) (mA)	Trip Current (at +25°C) (mA)	Trip Current (at -40°C) (mA)	Max. Current (A)	Resistance (at +25°C) (ohm)	Body Diameter (D)(mm)	Thickness (T) (mm)	Height (H) (mm)	Lead Space (F)(mm)	Lead Diameter (phi d)(mm)
PTGL4SAS100K2N51B0	30	65	92	154	205	261	1.5	10 ±10%	4.5	3.5	9.5	5.0	0.5
PTGL4SAS100K2B51B0	30	89	127	212	282	359	2.0	10 ±10%	4.5	3.5	9.5	5.0	0.6
PTGL5SAS3R9K2B51B0	30	143	204	340	452	576	3.5	3.9 ±10%	5.5	3.5	10.5	5.0	0.6
PTGL7SAS2R7K2B51B0	30	179	255	425	565	720	4.5	2.7 ±10%	7.3	3.5	12.3	5.0	0.6
PTGL7SAS1R8K2B51B0	30	223	319	532	708	902	5.0	1.8 ±10%	7.3	3.5	12.3	5.0	0.6
PTGL9SAS1R2K2B51B0	30	296	422	704	936	1193	6.0	1.2 ±10%	9.3	3.5	14.3	5.0	0.6
PTGLCSAS0R8K2B51B0	30	364	520	867	1153	1470	7.0	0.8 ±10%	11.5	3.5	16.5	5.0	0.6
PTGL4SAS100K3B51B0	51	89	128	213	283	361	1.0	10 ±10%	4.5	3.5	9.5	5.0	0.6
PTGL5SAS6R8K3B51B0	51	105	149	249	331	422	1.5	6.8 ±10%	5.5	3.5	10.5	5.0	0.6
PTGL7SAS3R3K3B51B0	51	163	233	389	517	659	3.0	3.3 ±10%	7.3	3.5	12.3	5.0	0.6
PTGL9SAS2R2K3B51B0	51	219	313	522	694	885	4.0	2.2 ±10%	9.3	3.5	14.3	5.0	0.6
PTGLCSAS1R2K3B51B0	51	315	449	749	996	1270	5.0	1.2 ±10%	11.5	3.5	16.5	5.0	0.6
PTGL4SAS220K4N51B0	60	47	67	112	149	190	1.0	22 ±10%	4.5	3.5	9.5	5.0	0.5
PTGL4SAS220K4B51B0	60	61	87	145	193	246	1.0	22 ±10%	4.5	3.5	9.5	5.0	0.6
PTGL5SAS100K4B51B0	60	90	129	215	286	364	1.5	10 ±10%	5.5	3.5	10.5	5.0	0.6
PTGL7SAS5R6K4N51B0	60	99	142	236	314	400	2.2	5.6 ±10%	7.3	3.5	12.3	5.0	0.5
PTGL7SAS5R6K4B51B0	60	122	174	290	386	492	3.0	5.6 ±10%	7.3	3.5	12.3	5.0	0.6
PTGL9SAS3R3K4B51B0	60	177	253	421	560	714	4.0	3.3 ±10%	9.3	3.5	14.3	5.0	0.6
PTGLCSAS2R2K4B51B0	60	234	334	556	739	942	5.0	2.2 ±10%	11.5	3.5	16.5	5.0	0.6
PTGL4SAS560K6B51B0	140	39	56	94	125	159	0.5	56 ±10%	4.5	4.5	9.5	5.0	0.6
PTGL5SAS270K6B51B0	140	56	80	134	178	227	1.0	27 ±10%	5.5	4.5	10.5	5.0	0.6
PTGL7SAS150K6B51B0	140	79	112	187	249	317	1.5	15 ±10%	7.3	4.5	12.3	5.0	0.6
PTGL9SAS120K6B51B0	140	102	146	244	324	413	2.0	12 ±10%	9.3	4.5	14.3	5.0	0.6
PTGL9SAS7R6K6B51B0	140	121	172	287	382	486	2.2	7.6 ±10%	9.3	4.5	14.3	5.0	0.6
PTGLCSAS4R7K6B51B0	140	165	236	393	523	666	3.5	4.7 ±10%	11.5	4.5	16.5	5.0	0.6

Maximum Current shows typical capacities at which the transformer can be used.

Operating Temperature Range: -40°C to +125°C

Taping type of part numbers with "A0" is available.

△Note • Please read rating and △CAUTION (for storage, operating, rating, soldering, mounting and handling) in this catalog to prevent smoking and/or burning, etc.
 • This catalog has only typical specifications because there is no space for detailed specifications. Therefore, please review our product specifications or consult the approval sheet for product specifications before ordering.

■ Protective Threshold Current Range (16V Series)

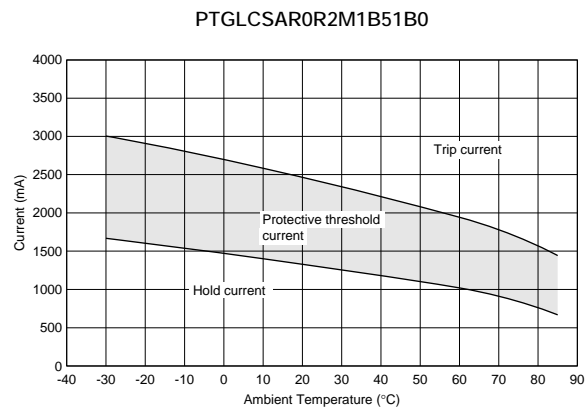
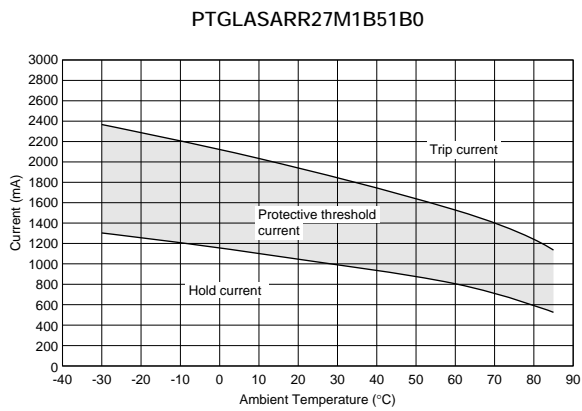
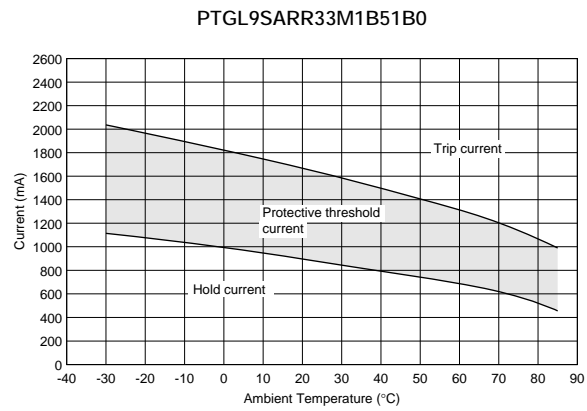
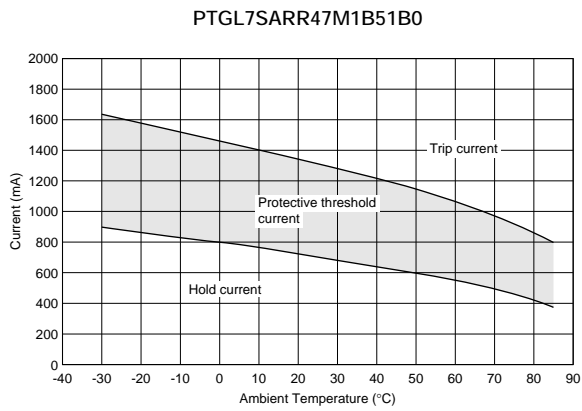
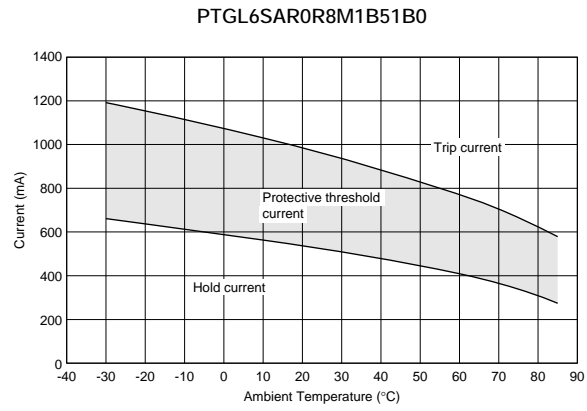
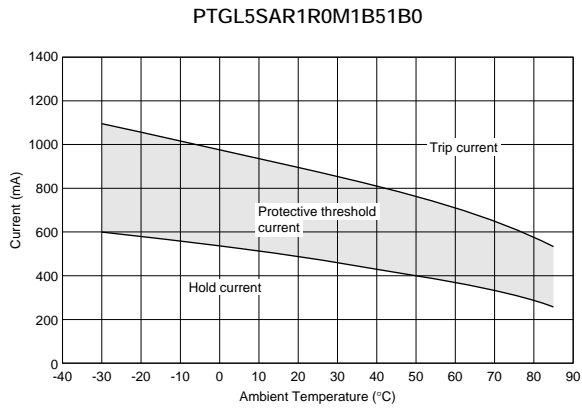

7

■ Protective Threshold Current Range (30V Series)

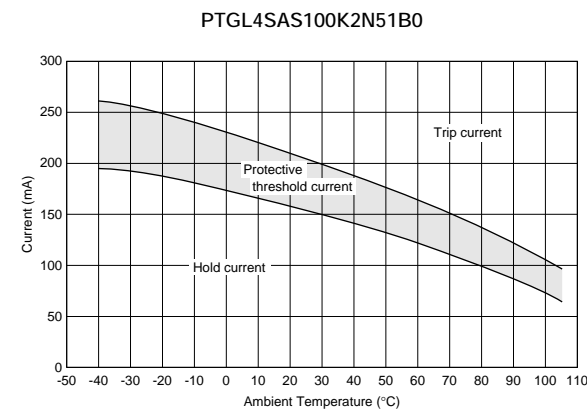
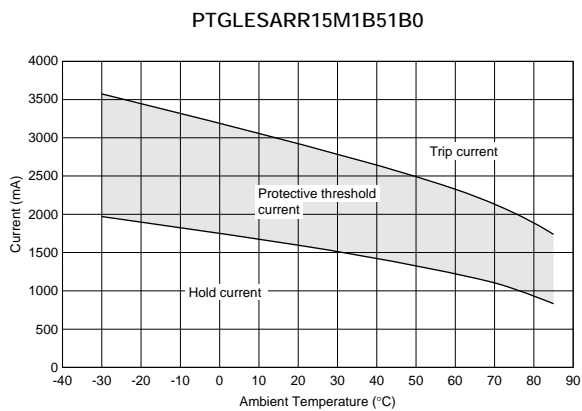

Continued on the following page. ↗

△Note • Please read rating and △CAUTION (for storage, operating, rating, soldering, mounting and handling) in this catalog to prevent smoking and/or burning, etc.
 • This catalog has only typical specifications because there is no space for detailed specifications. Therefore, please review our product specifications or consult the approval sheet for product specifications before ordering.

Continued from the preceding page.

■ Protective Threshold Current Range (30V Series)

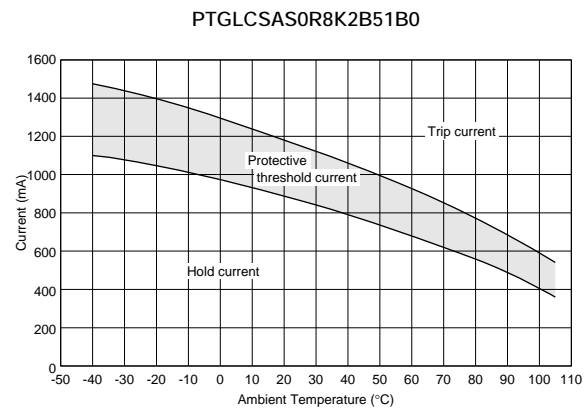
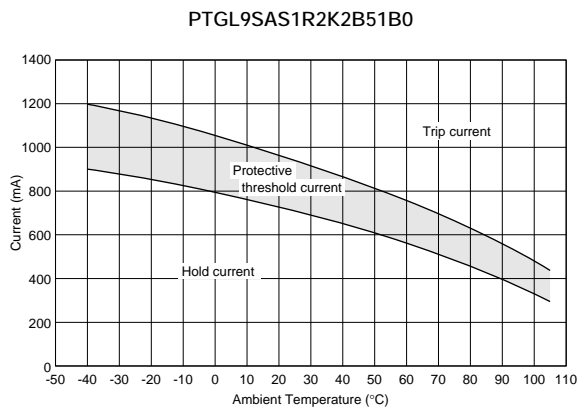
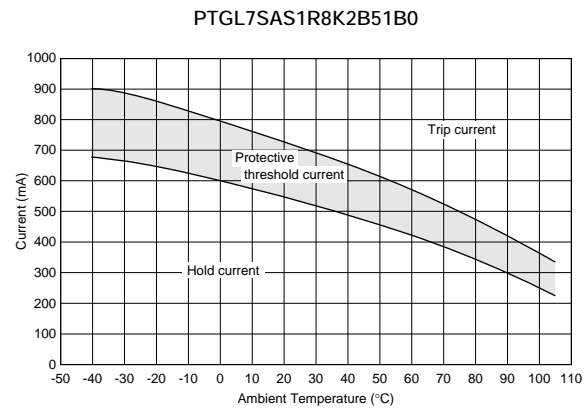
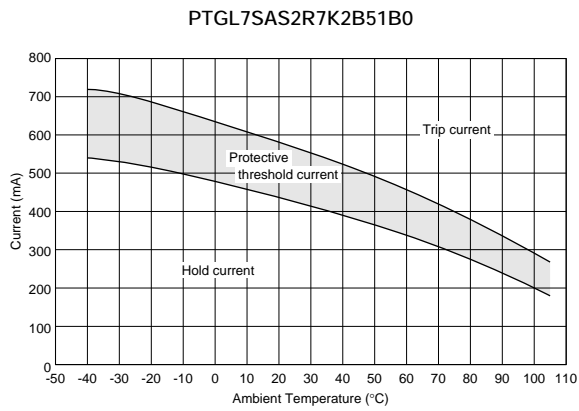
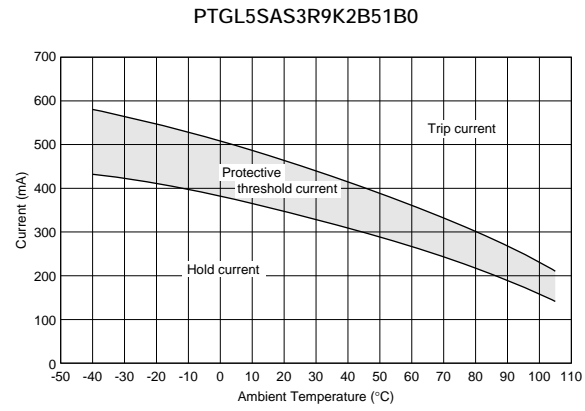
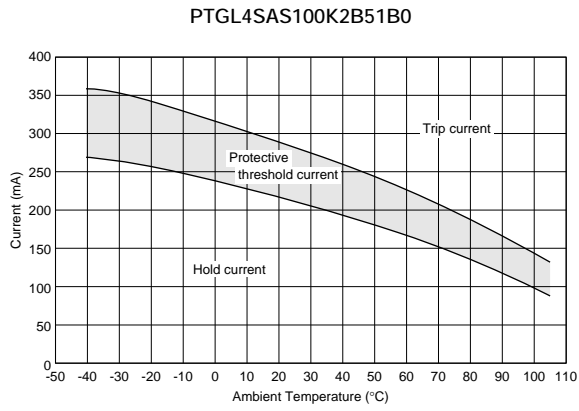

7

■ Protective Threshold Current Range (51V Series)

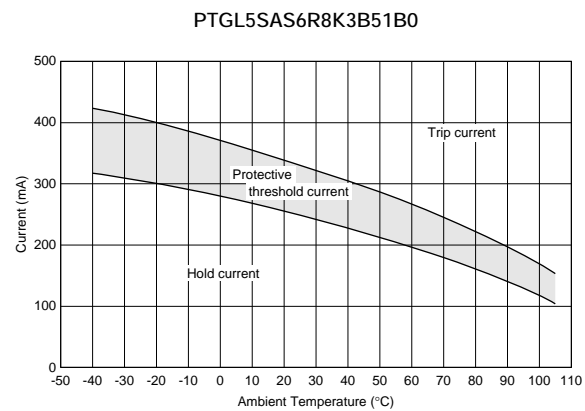
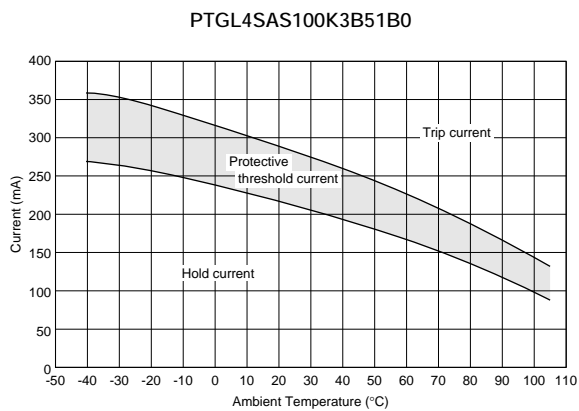

Continued on the following page.



△Note • Please read rating and △CAUTION (for storage, operating, rating, soldering, mounting and handling) in this catalog to prevent smoking and/or burning, etc.
 • This catalog has only typical specifications because there is no space for detailed specifications. Therefore, please review our product specifications or consult the approval sheet for product specifications before ordering.

Continued from the preceding page.

■ Protective Threshold Current Range (51V Series)

PTGL7SAS3R3K3B51B0

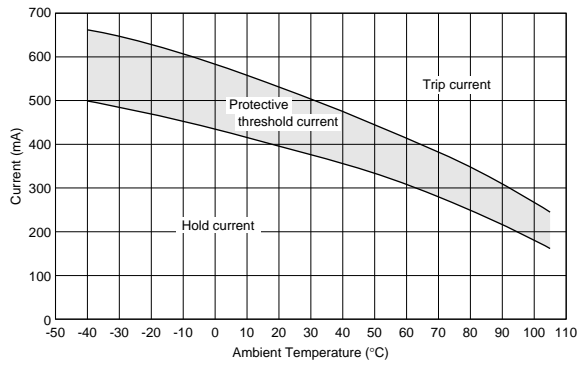

PTGL9SAS2R2K3B51B0

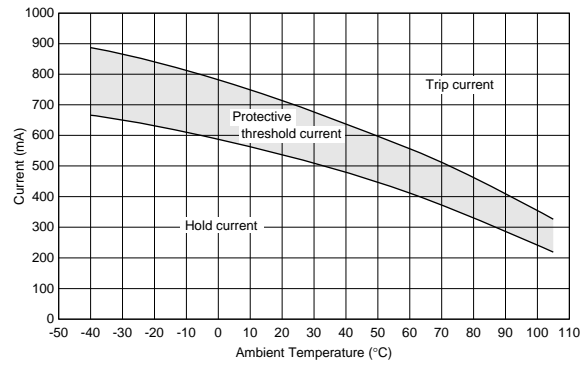

■ Protective Threshold Current Range (60V Series)

PTGLCSAS1R2K3B51B0

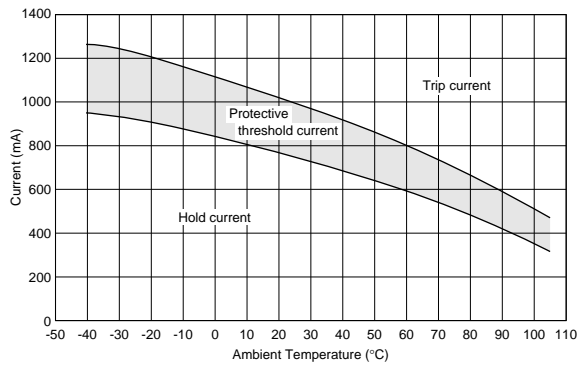

PTGL4SAS220K4N51B0

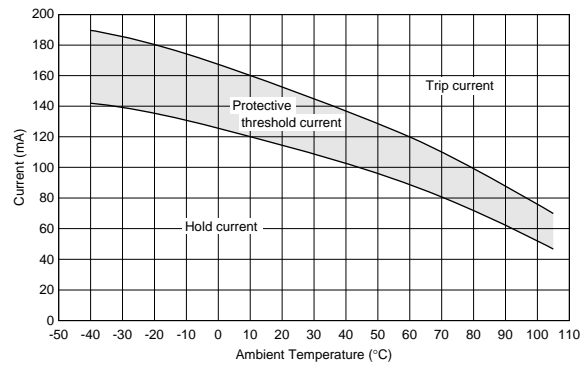

PTGL4SAS220K4B51B0

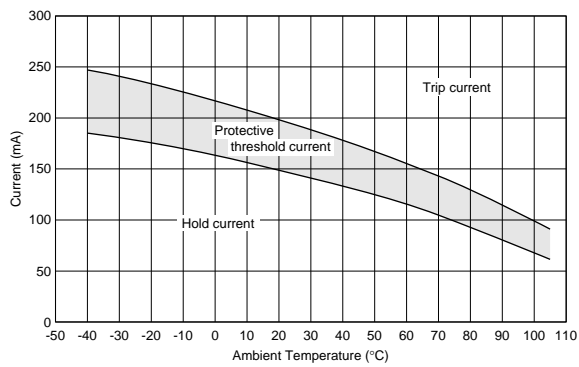

PTGL5SAS100K4B51B0

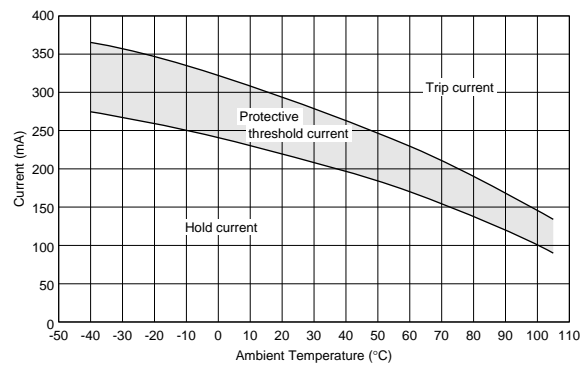

PTGL7SAS5R6K4N51B0

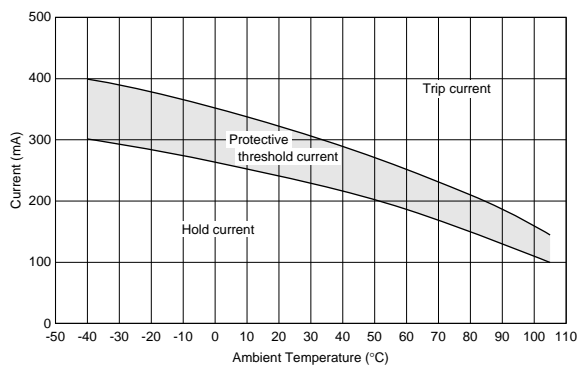

PTGL7SAS5R6K4B51B0

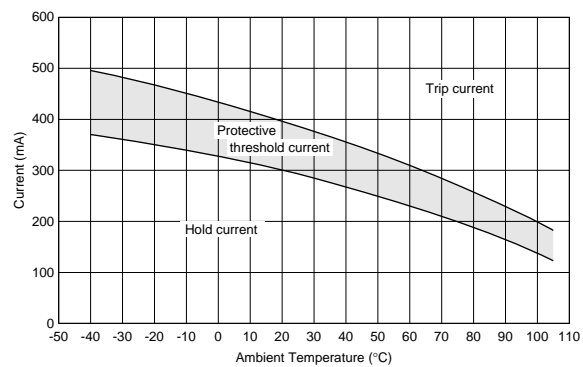

7

Continued on the following page. ↗

△Note • Please read rating and △CAUTION (for storage, operating, rating, soldering, mounting and handling) in this catalog to prevent smoking and/or burning, etc.
 • This catalog has only typical specifications because there is no space for detailed specifications. Therefore, please review our product specifications or consult the approval sheet for product specifications before ordering.

Continued from the preceding page.

■ Protective Threshold Current Range (60V Series)

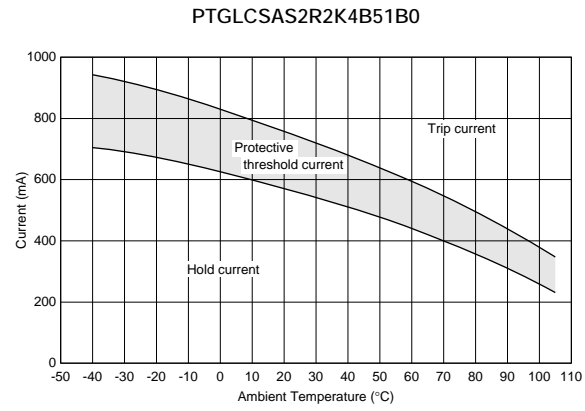
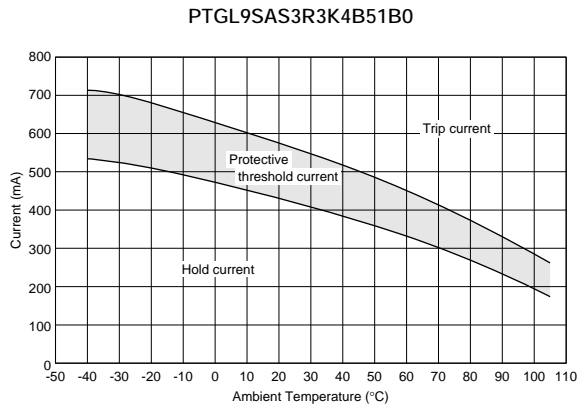

■ Protective Threshold Current Range (140V Series)

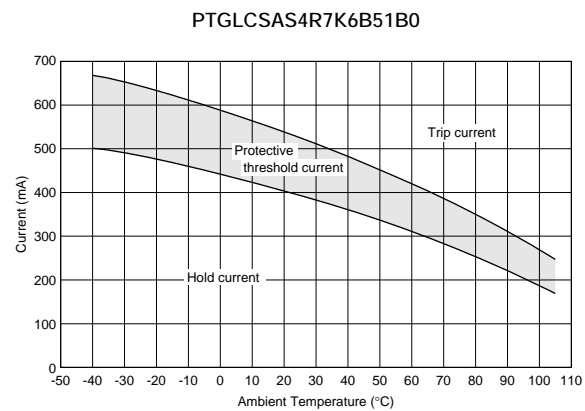
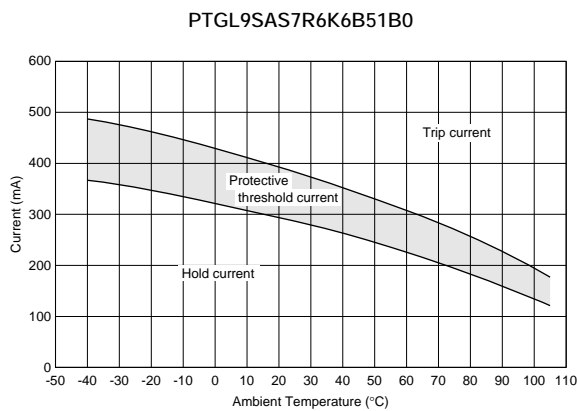
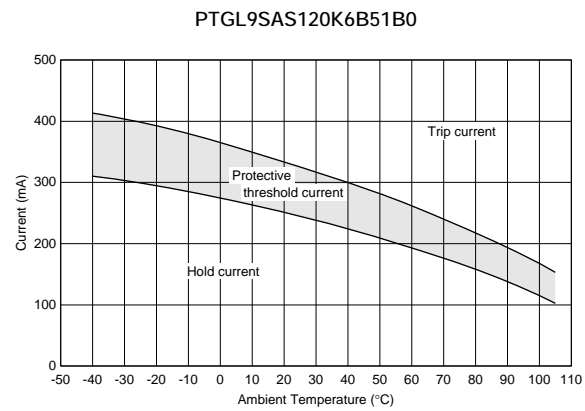
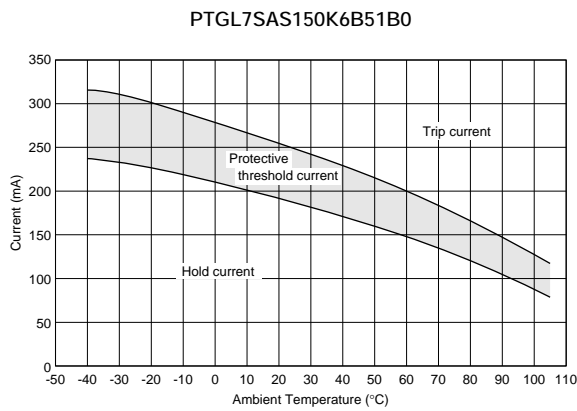
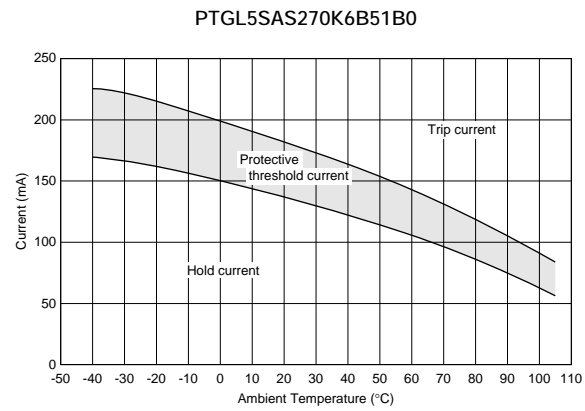
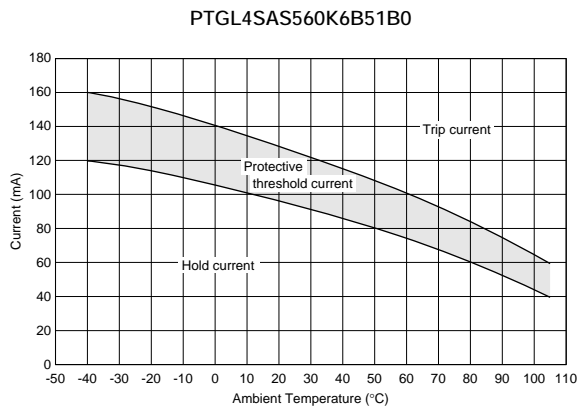

7

Continued on the following page. ↗

⚠Note • Please read rating and ⚠CAUTION (for storage, operating, rating, soldering, mounting and handling) in this catalog to prevent smoking and/or burning, etc.
 • This catalog has only typical specifications because there is no space for detailed specifications. Therefore, please review our product specifications or consult the approval sheet for product specifications before ordering.

↳ Continued from the preceding page.

■ Operating Time (Typical Curve) (16V Series)

PTGL5SAR1R0M1B51B0

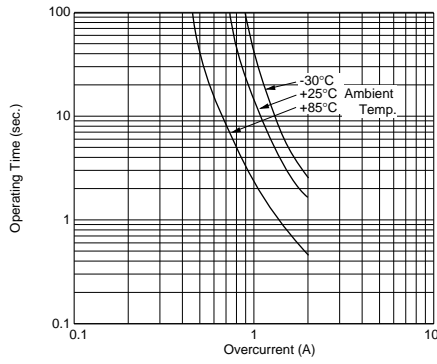

PTGL6SAR0R8M1B51B0

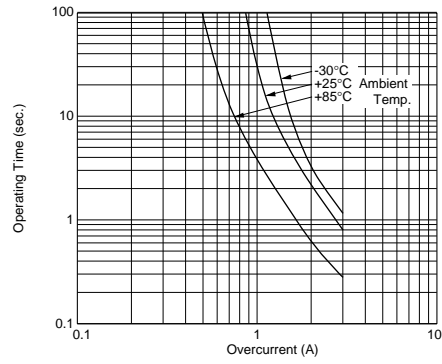

PTGL7SARR47M1B51B0

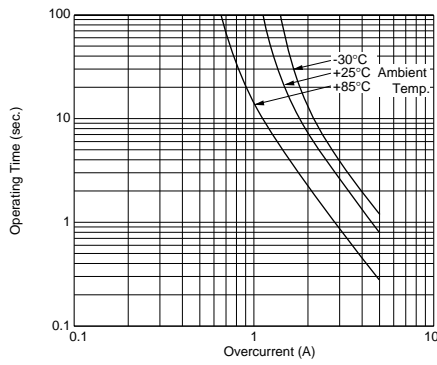

PTGL9SARR33M1B51B0

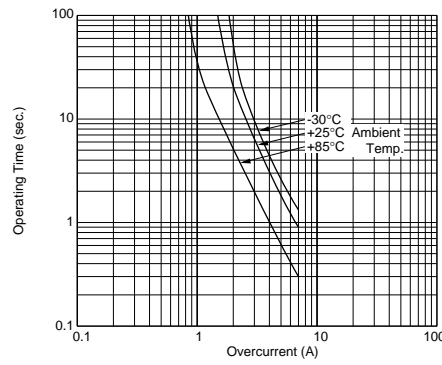

PTGLASARR27M1B51B0

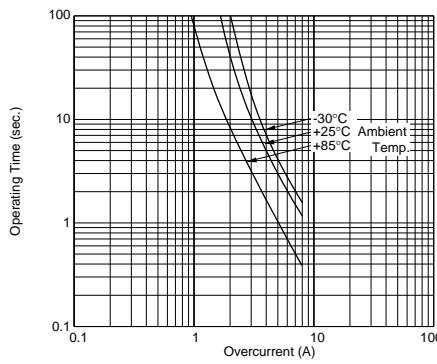

PTGLCSAR0R2M1B51B0

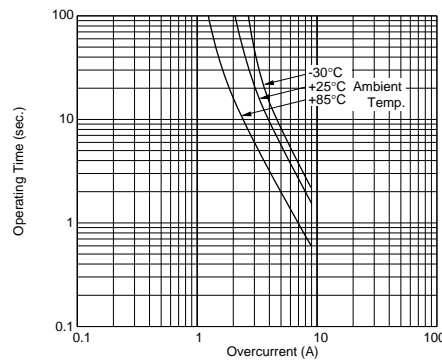

7

■ Operating Time (Typical Curve) (30V Series)

PTGLESARR15M1B51B0

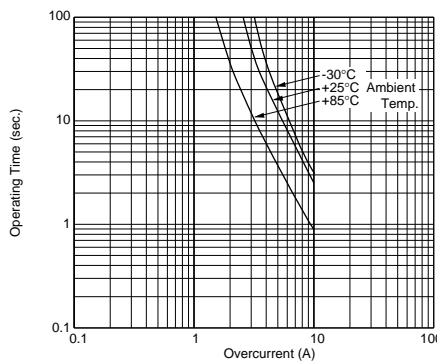

PTGL4SAS100K2N51B0

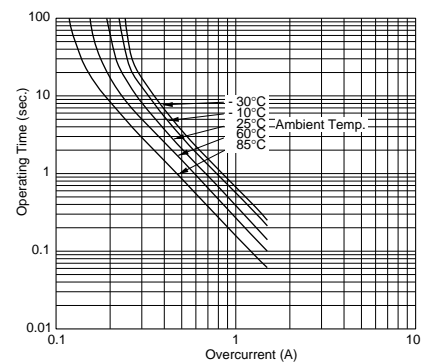

Continued on the following page. ↗

△Note • Please read rating and △CAUTION (for storage, operating, rating, soldering, mounting and handling) in this catalog to prevent smoking and/or burning, etc.
 • This catalog has only typical specifications because there is no space for detailed specifications. Therefore, please review our product specifications or consult the approval sheet for product specifications before ordering.

Continued from the preceding page.

■ Operating Time (Typical Curve) (30V Series)

PTGL4SAS100K2B51B0

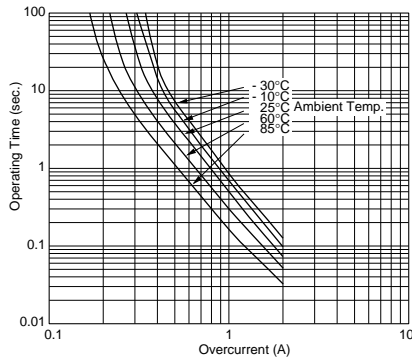

PTGL5SAS3R9K2B51B0

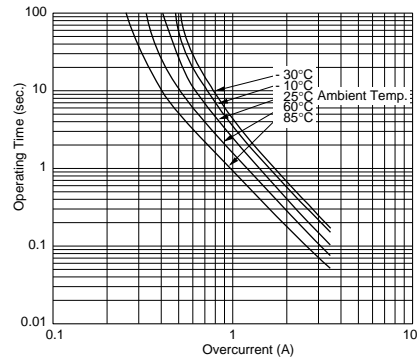

PTGL7SAS2R7K2B51B0

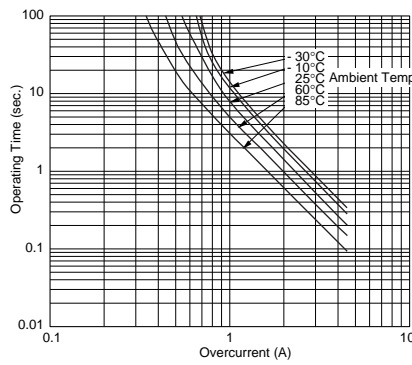

PTGL7SAS1R8K2B51B0

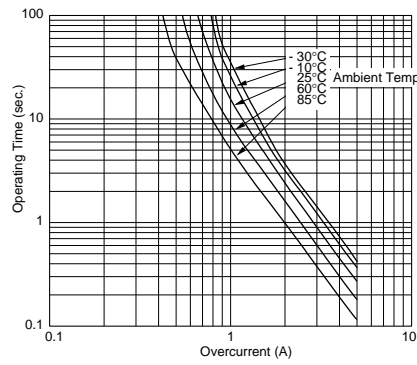

PTGL9SAS1R2K2B51B0

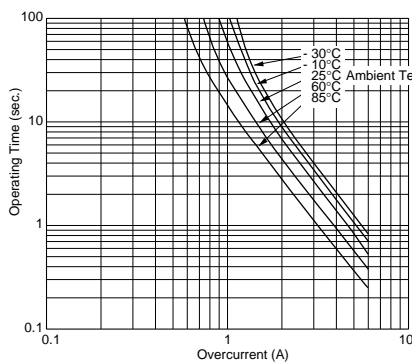

PTGLCSAS0R8K2B51B0

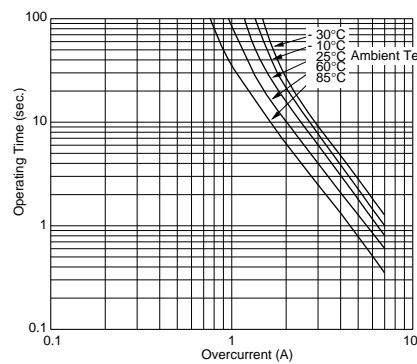

7

■ Operating Time (Typical Curve) (51V Series)

PTGL4SAS100K3B51B0

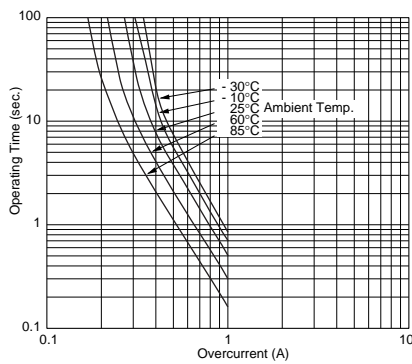

PTGL5SAS6R8K3B51B0

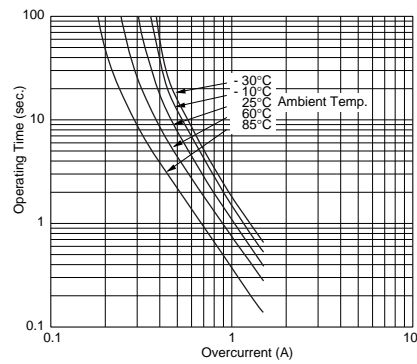

Continued on the following page.



△Note • Please read rating and △CAUTION (for storage, operating, rating, soldering, mounting and handling) in this catalog to prevent smoking and/or burning, etc.
 • This catalog has only typical specifications because there is no space for detailed specifications. Therefore, please review our product specifications or consult the approval sheet for product specifications before ordering.

Continued from the preceding page.

■ Operating Time (Typical Curve) (51V Series)

PTGL7SAS3R3K3B51B0

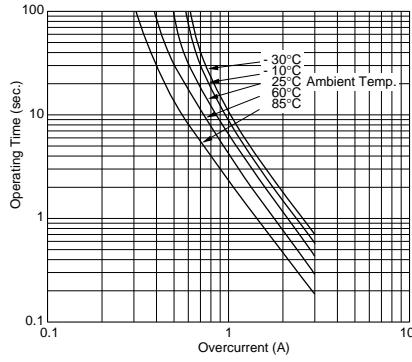

PTGL9SAS2R2K3B51B0

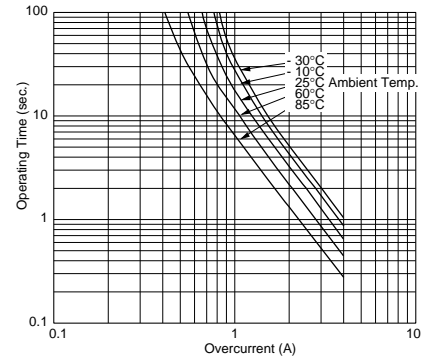

■ Operating Time (Typical Curve) (60V Series)

PTGLCSAS1R2K3B51B0

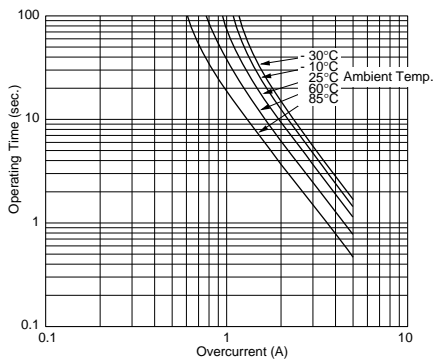

PTGL4SAS220K4N51B0

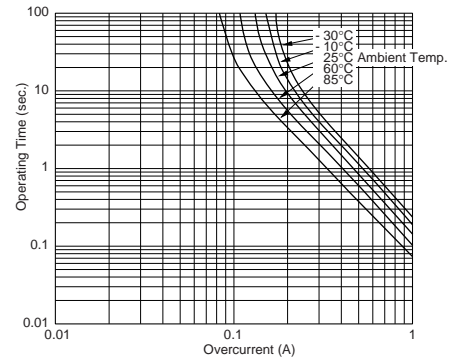

PTGL4SAS220K4B51B0

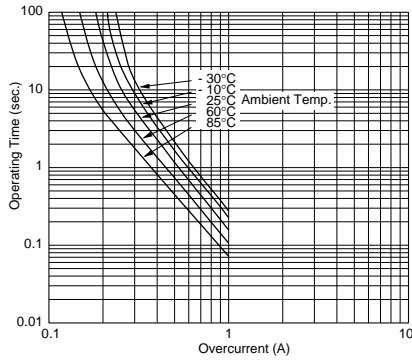

PTGL5SAS100K4B51B0

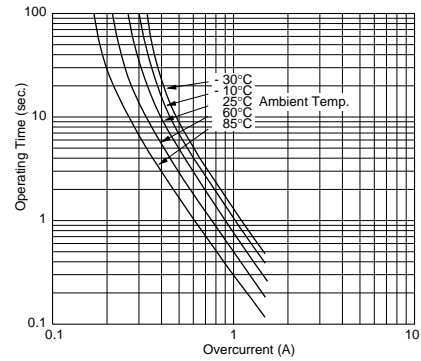

PTGL7SAS5R6K4N51B0

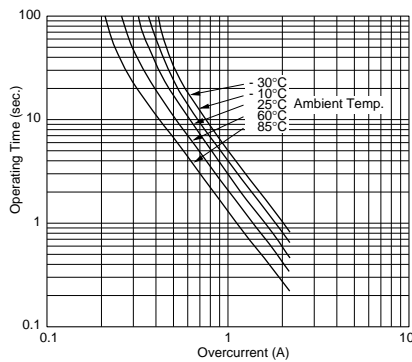

PTGL7SAS5R6K4B51B0

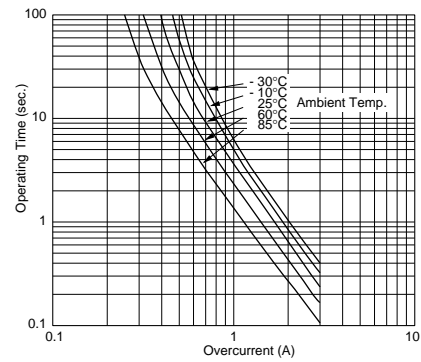

7

Continued on the following page. ↗

△Note • Please read rating and △CAUTION (for storage, operating, rating, soldering, mounting and handling) in this catalog to prevent smoking and/or burning, etc.
 • This catalog has only typical specifications because there is no space for detailed specifications. Therefore, please review our product specifications or consult the approval sheet for product specifications before ordering.

Continued from the preceding page.

■ Operating Time (Typical Curve) (60V Series)

PTGL9SAS3R3K4B51B0

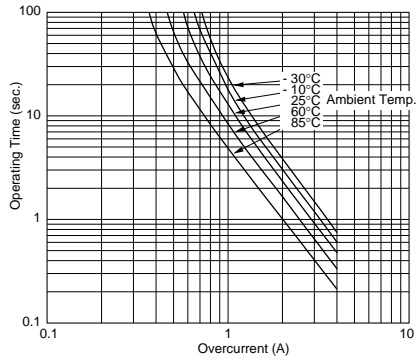

PTGLCSAS2R2K4B51B0

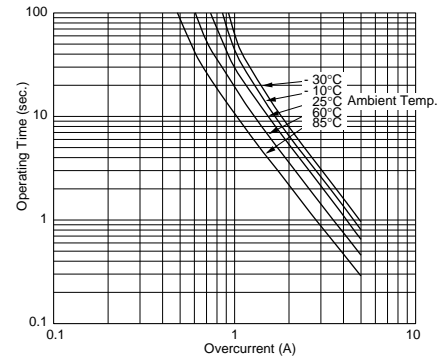

■ Operating Time (Typical Curve) (140V Series)

PTGL4SAS560K6B51B0

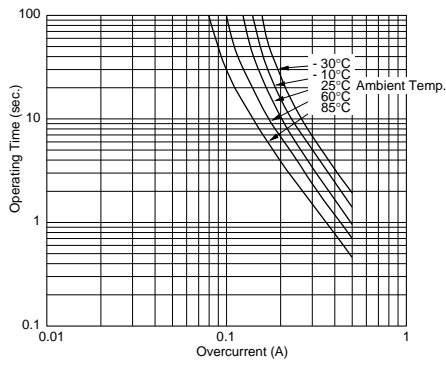

PTGL5SAS270K6B51B0

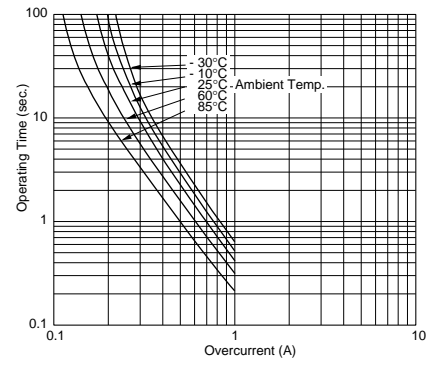

PTGL7SAS150K6B51B0

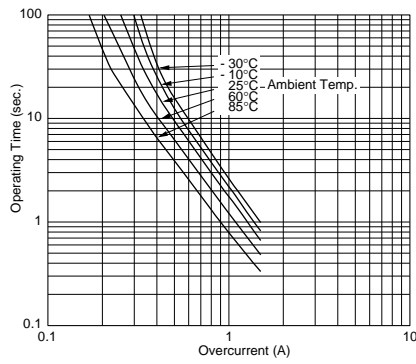

PTGL9SAS120K6B51B0

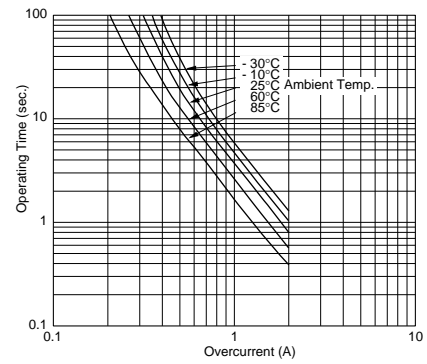

PTGL9SAS7R6K6B51B0

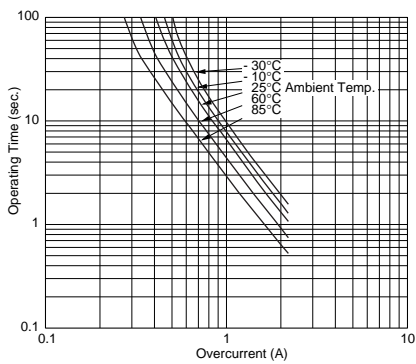

PTGLCSAS4R7K6B51B0

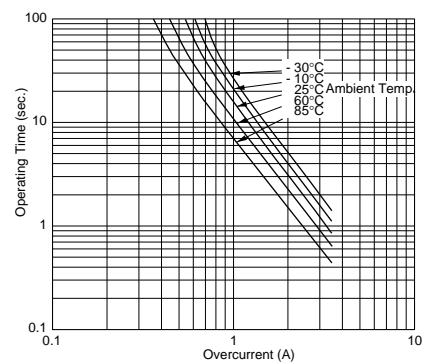

POSISTOR® Lead Type for Overcurrent Protection Specifications and Test Methods

■16V Series

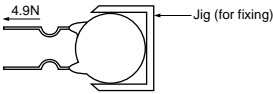
No.	Item	Rating Value	Method of Examination
1	Operating Temperature	-30 to +85°C	The temperature range with maximum voltage applied to the POSISTOR®.
2	Resistance (R25)	Satisfies specification	Resistance value is measured by applying voltage under 1.5Vdc (by a direct current of less than 10mA) at 25°C. (But it must be measured after maximum voltage is applied 180 seconds and then is left for 2 hours at 25°C.)
3	Withstanding Voltage	No damage	We apply AC voltage 110% that of the maximum voltage to POSISTOR® by raising voltage gradually for 180±5 seconds at 25°C. (A protective resistor is to be connected in series, and the inrush current through POSISTOR® must be limited below maximum rated value.)
4	Protective Threshold Current	Satisfies ratings (Trip Current, Non-operating Current)	Maximum current is measured in this examination. Voltage is applied to POSISTOR® in 3-minute steps still air. Stable current is measured at each step.
5	Tensile Strength of Lead Wire Terminal	No damage	The load is gradually applied to each terminal of POSISTOR® until the force of 4.9N in the axial direction with fixing POSISTOR®'s body itself by a jig and this load is being kept for 10 seconds. 
6	Bending Strength of Lead Wire Terminal	Lead wire does not come off	POSISTOR® is held so that it is perpendicular to the lead wire with 2.45N in the axial direction of the lead wire. The lead wire is slowly bent to 90° and returned; then it is slowly bent in the opposite direction and returned to original state.
7	Solderability	Solder is applied around the lead wire covering 3/4 or more of the circumference without a gap in the axial direction.	The lead wire of POSISTOR® is soaked in an Isopropyl Alcohol (JIS K 8839) solution (about 25wt%) of colophony (JIS K 5902) for 5-10 seconds. Then, each lead wire is soaked in molten solder (JIS Z 3282 H60A) at 235±5°C from the bottom to a point of 2.0-2.5mm for 2±0.5 seconds.
8	Terminal Durability of Soldering	$\Delta R/R25 \leq \pm 15\%$	The lead wire of POSISTOR® is soaked in molten solder (JIS Z 3282 H60A) at 350±10°C from the bottom to a point of 2.0-2.5mm for 3.5±0.5 seconds. After the device is left at room temperature (25°C) for 24±4 hours, the resistance is measured.
9	Heat Resistant	$\Delta R/R25 \leq \pm 20\%$ No damage about marking	In an 85±3°C chamber, POSISTOR® is applied max. voltage for 1.5 hr on and 0.5 hr off. This cycle is repeated for 500±10 hours, and after the device is left at room temperature (25°C) for 1 hour, the resistance measurement is performed. (A protective resistance is to be connected in series and the inrush current through POSISTOR® must be limited below max. rated value.)
10	Resistance to Damp Heat	$\Delta R/R25 \leq \pm 20\%$ No damage about marking	POSISTOR® is set in an environmental chamber at 40±2°C and 90% to 95% humidity, for 500±4 hours. Then, after the device is left at room temperature (25°C) for 1 hour, the resistance measurement is performed.

POSISTOR® Lead Type for Overcurrent Protection Specifications and Test Methods

■30-140V Series

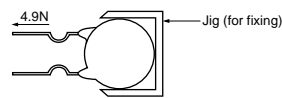
No.	Item	Rating Value	Method of Examination
1	Operating Temperature 1	-30 to +125°C	The temperature range with maximum voltage applied to the POSISTOR®.
2	Operating Temperature 2	-40 to +125°C	The temperature range with the following voltage applied to the POSISTOR®. <applied voltage> 30V and 51V series: max. 16V, 60V series: max. 30V, 140V series: max. 140V
3	Resistance (R25)	Satisfies ratings	Resistance value is measured by applying voltage under 1.0Vdc (by a direct current of less than 10mA) at 25°C. (But it must be measured after it is applied maximum voltage for 180 seconds and then is left for 2 hours at 25°C.)
4	Withstanding Voltage	No damage	We apply AC voltage 120% that of the maximum voltage to POSISTOR® by raising voltage gradually for 180±5 seconds at 25°C. (A protective resistor is to be connected in series, and the inrush current through POSISTOR® must be limited below max. rated value.)
5	Protective Threshold Current	Satisfies ratings (Trip Current, Non-operating Current)	Maximum current is measured in this examination. Voltage is applied to POSISTOR® in 3-minute steps still air based on "Protective Threshold Current Test Conditions" shown in next page. Stable current is measured at each step.
6	Tensile Strength of Lead Wire Terminal	No damage	The load is gradually applied to each terminal of POSISTOR® until the force of 4.9N in the axial direction with fixing POSISTOR®'s body itself by a jig and this load is being kept for 10 seconds. 
7	Bending Strength of Lead Wire Terminal	Lead wire does not come off	POSISTOR® is held so that it is perpendicular to the lead wire with 2.45N in the axial direction of the lead wire. The lead wire is slowly bent to 90° and returned; then it is slowly bent in the opposite direction and returned to original state.
8	Solderability	Solder is applied around the lead wire covering 3/4 or more of the circumference without a gap in the axial direction.	The lead wire of POSISTOR® is soaked in an Isopropyl Alcohol (JIS K 8839) solution (about 25wt%) of colophony (JIS K 5902) for 5-10 sec. Then, each lead wire is soaked in molten solder (JIS Z 3282 H60A) at 235±5°C from the bottom to a point of 2.0-2.5mm for 2±0.5 seconds.
9	Terminal Durability of Soldering	$\Delta R/R25 \leq \pm 15\%$	The lead wire of POSISTOR® is soaked in molten solder (JIS Z 3282 H60A) at 350±10°C from the bottom to a point of 2.0-2.5mm for 3.5±0.5 sec. After the device is left at room temperature (25°C) for 24±4 hours, the resistance is measured.
10	Vibration Resistant	$\Delta R/R25 \leq \pm 20\%$	Acceleration: 98m/s ² (10G) Width: 1.5mm Vibration: 10-500-10Hz Vibrate for 11 minutes × 24 cycles in each of 3 mutually perpendicular planes for a total of 13.5 hours.
11	Heat Resistant	$\Delta R/R25 \leq \pm 20\%$	POSISTOR® is set in an environmental chamber at 125±3°C for 1000±12 hours. After the device is left at room temperature (25°C) for one hour, the resistance measurement is performed.
12	Cold Resistant	$\Delta R/R25 \leq \pm 20\%$	POSISTOR® is set in an environmental chamber at -40±3°C for 1000±12 hours. After the device is left at room temperature (25°C) for one hour, the resistance measurement is performed.
13	Resistance to Damp Heat	$\Delta R/R25 \leq \pm 20\%$	POSISTOR® is set in an environmental chamber at 85±3°C and 80-85% humidity for 1000±12 hours. After the device is left at room temperature (25°C) for one hour, the resistance measurement is performed.

Continued on the following page. 

POSISTOR® Lead Type for Overcurrent Protection Specifications and Test Methods

Continued from the preceding page.

Protective Threshold current test conditions

(1) Substrate

Materials: Phenol

Size: 50x50x1.6mm

Land Pattern: Cu land without through hole

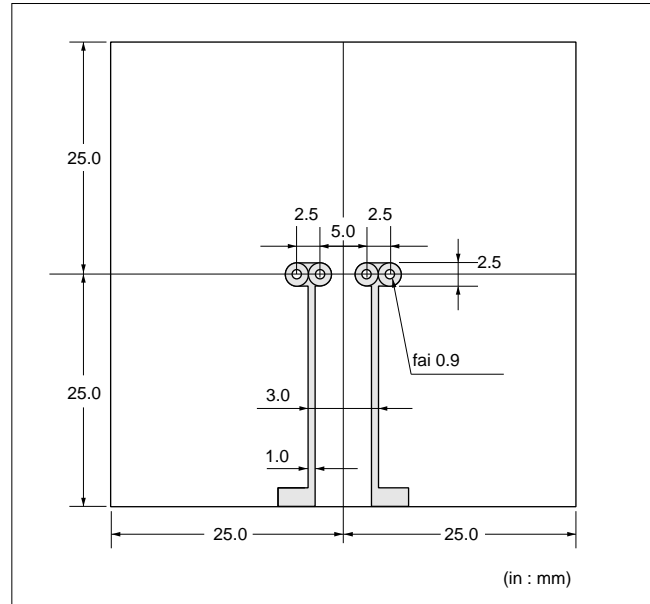

(2) Measurement condition

Solder POSISTOR® on the substrate, then put a cover (150mm cubed) surround POSISTOR® to prevent flow of wind.

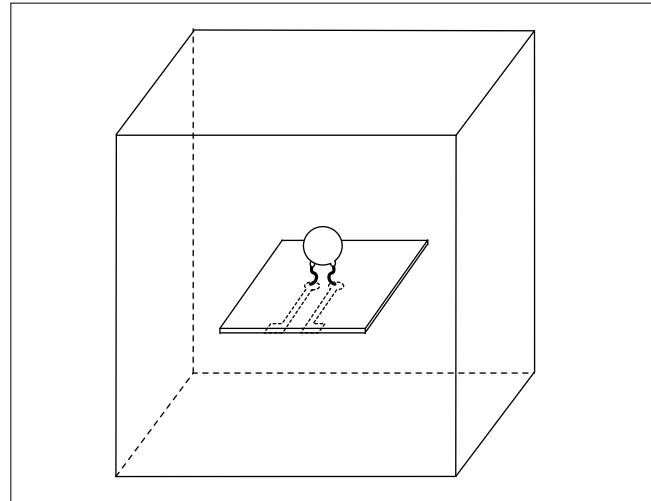

7

(3) Measurement circuit

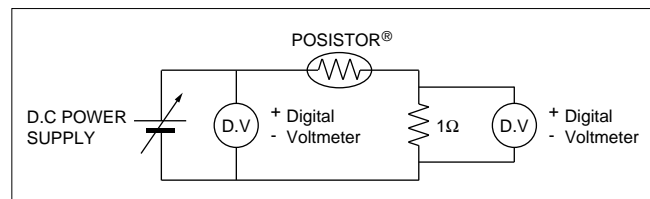

POSISTOR® Lead Type for Overcurrent Protection ⚠Caution/Notice

■ ⚠Caution (Storage and Operating Conditions)

This product is designed for application in an ordinary environment (normal room temperature, humidity and atmospheric pressure). Do not use under the following conditions because all of these factors can deteriorate the characteristics or cause product failure and burn-out.

1. Corrosive gas or deoxidizing gas (Chlorine gas, Hydrogen sulfide gas, Ammonia gas, Sulfuric acid gas, Nitric oxide gas, etc.)
2. Volatile or flammable gas
3. Dusty conditions
4. Under vacuum, or under high or low pressure
5. Wet or humid conditions
6. Places with salt water, oils, chemical liquids or organic solvents
7. Strong vibrations
8. Other places where similar hazardous conditions exist

■ ⚠Caution (Other)

Be sure to provide an appropriate fail-safe function on your product to prevent secondary damage that may be caused by the abnormal function or the failure of our product.

■ Notice (Storage and Operating Conditions)

To keep solderability of product from declining, the following storage conditions are recommended.

1. Storage condition:
Temperature -10 to +40°C
Humidity less than 75%RH (not dewing condition)
2. Storage term:
Use this product within 6 months after delivery by first-in and first-out stocking system.
3. Handling after unpacking:
After unpacking, promptly reseal this product or store it in a sealed container with a drying agent.
4. Storage place:
Do not store this product in corrosive gas (Sulfuric acid, Chlorine, etc.) or in direct sunlight.

■ Notice (Soldering and Mounting)

When the lead of this product is soldered, pay attention as follows to avoid the decline of element characteristics or break-down of the element.

1. Use Rosin type flux or non-activated flux
2. Do not dip the body into flux (flux should be coated to lead wire only for soldering).
3. Be sure that preheating does not melt the soldering of this product.

■ Notice (Handling)

1. Do not apply an excessive force to the lead. Otherwise, it may cause the junction between lead and element to break, or may crack the element. Therefore, holding the element side lead wire is recommended when lead wire is bent or cut.
2. This product does not have waterproof construction. Splashed water may cause failure mode such as decline of characteristics or current leak.
3. When this product is operated, the temperature of some areas may be over 100 to 160°C. Be sure that surrounding parts and inserting material can withstand the temperature. If the surrounding part and material are kept under such conditions, they may deteriorate or produce harmful gas (Chlorine gas, Hydrogen sulfide gas, Ammonia gas, Sulfuric acid gas, Nitric oxide gas, etc.), and such harmful gas may deteriorate the element.

NTC Thermistors Chip Type/Thermo String Type Package

Minimum Quantity Guide

Part Number	Quantity (pcs.)	
	Paper Tape	Embossed Tape
NCP15	10000	-
NCP18/NCG18	4000	-

Part Number	Quantity (pcs.)
	Bulk Type
NXF	1000

Chip Type/Tape Carrier Packaging

1. Dimensions of Reel

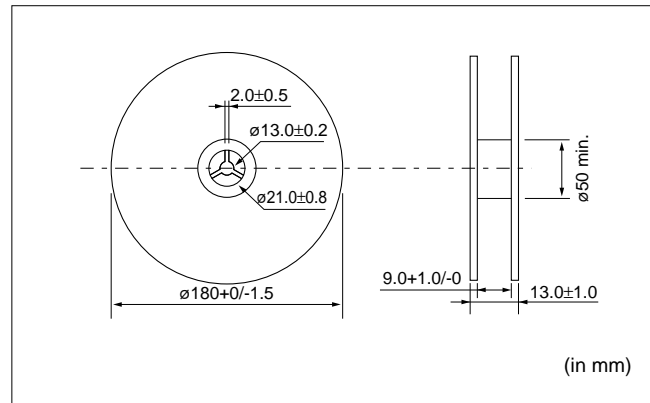

2. Taping Method

- (1) A tape in a reel contains Leader unit and Trailer unit where products are not packed. (Please refer to the figure at right.)
- (2) The top and base tapes or plastic and cover tape are not stuck at the first five pitches minimum.
- (3) A label should be attached on the reel. (MURATA's part number, inspection number and quantity should be marked on the label.)
- (4) Taping reels are packaged.

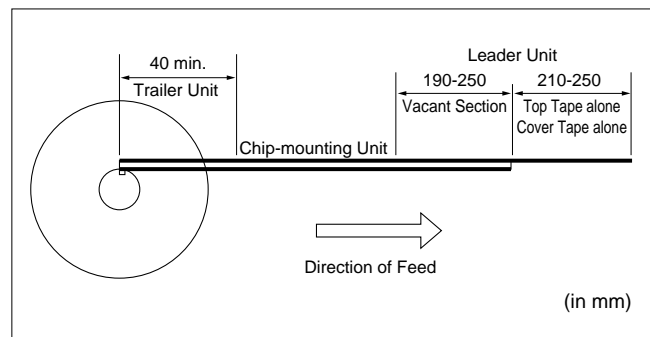

Continued on the following page. ↗

NTC Thermistors Chip Type/Thermo String Type Package

Continued from the preceding page.

3. Paper Tape

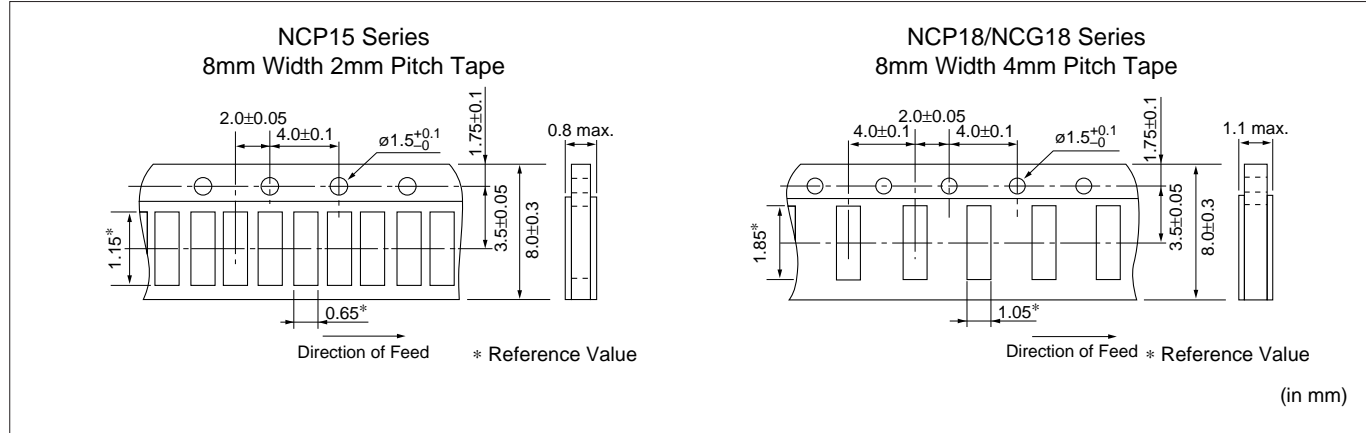

(1) Other Conditions

① Packaging

Products are packaged in the cavity of the base tape and sealed by top tape and bottom tape.

② Tape

Top tape and bottom tape have no joints and products are packaged and sealed in the cavity of the base tape, continuously.

(2) Peeling Force of Top Tape

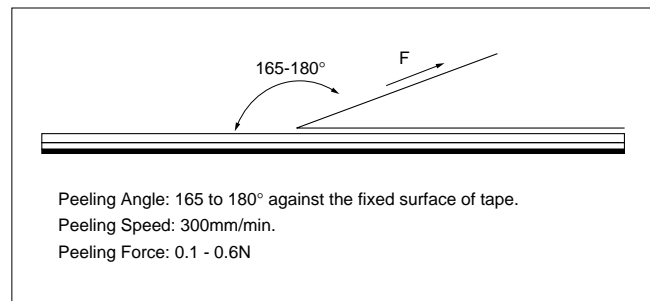

(3) Pull Strength

Pull strength of top tape is specified at 10N minimum.

Pull strength of bottom tape shall be specified 5N minimum.

POSISTOR[®] Chip Type Package

Minimum Quantity Guide

Part Number	Quantity (pcs.)	
	Paper Tape	Embossed Tape
PR*18_RB	4000	-
PR*21_RA	-	4000
PR*21_RK	-	3000

Tape Dimensions

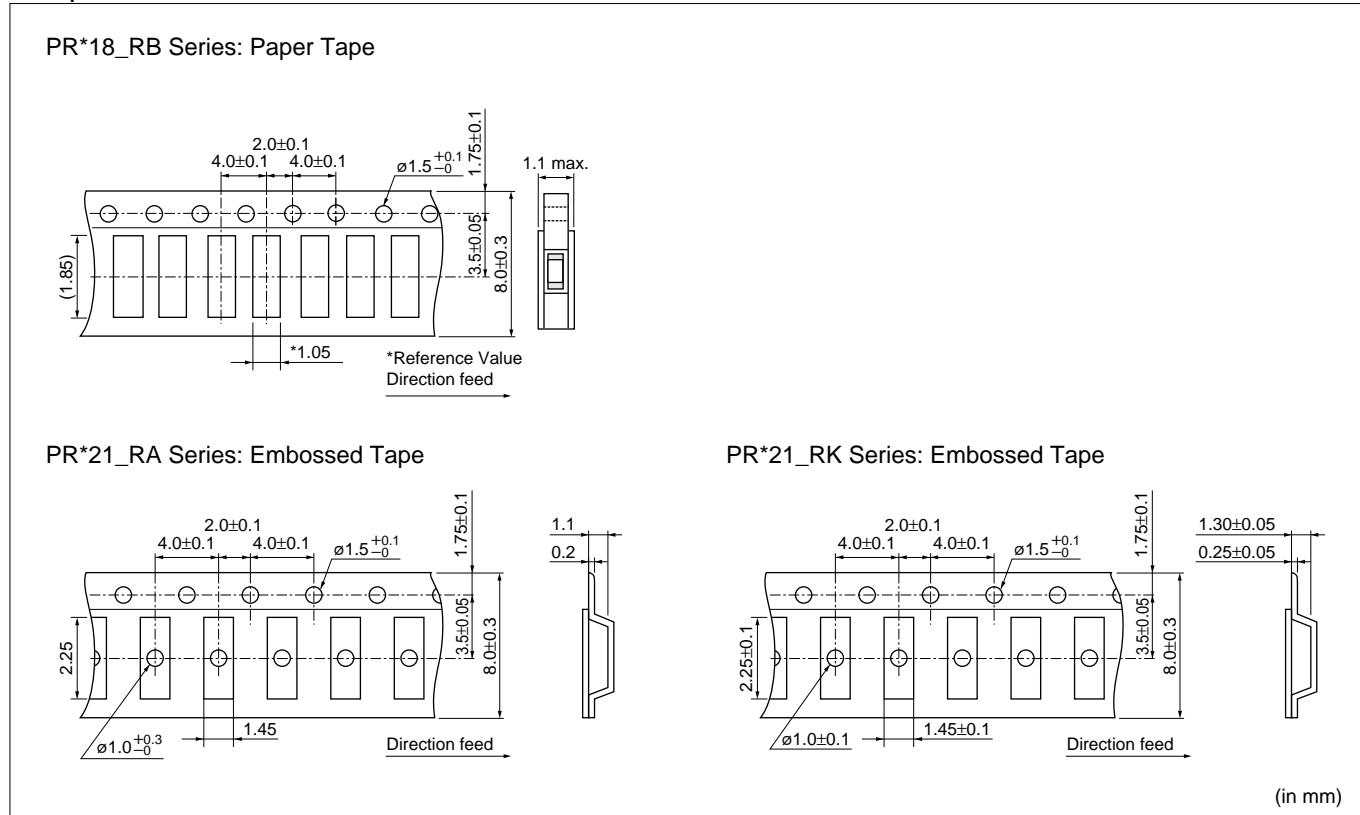

Reel Dimensions

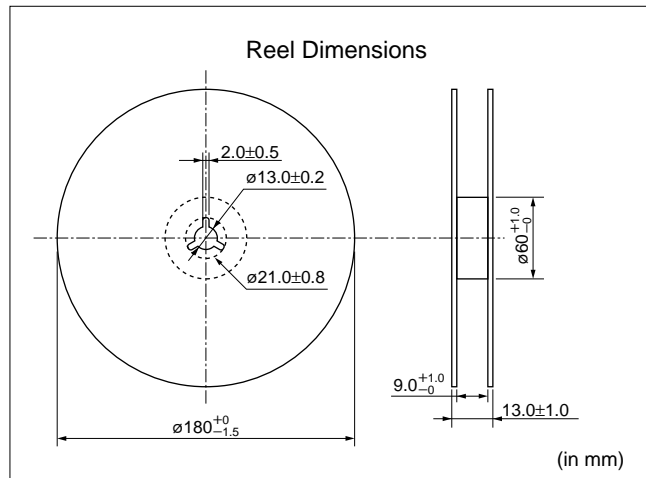

POSISTOR® Lead Type Package

■ Minimum Quantity Guide

Series	Bulk Type		Ammo Pack Taping Type	
	Part Number	Min. Qty. (pcs.)	Part Number	Min. Qty. (pcs.)
16V Series	PTGL5SAR1R0M1B51B0	500	PTGL5SAR1R0M1B51A0	2000
	PTGL6SAR0R8M1B51B0		PTGL6SAR0R8M1B51A0	
	PTGL7SARR47M1B51B0		PTGL7SARR47M1B51A0	
	PTGL9SARR33M1B51B0		PTGL9SARR33M1B51A0	
	PTGLASARR27M1B51B0	300	PTGLASARR27M1B51A0	-
	PTGLCSAR0R2M1B51B0		PTGLCSAR0R2M1B51A0	
	PTGLESARR15M1B51B0		-	
Narrow Current Band 30V Series	PTGL4SAS100K2B51B0	500	PTGL4SAS100K2B51A0	1500
	PTGL4SAS100K2N51B0		PTGL4SAS100K2N51A0	
	PTGL5SAS3R9K2B51B0		PTGL5SAS3R9K2B51A0	
	PTGL7SAS1R8K2B51B0		PTGL7SAS1R8K2B51A0	
	PTGL7SAS2R7K2B51B0		PTGL7SAS2R7K2B51A0	
	PTGL9SAS1R2K2B51B0	PTGL9SAS1R2K2B51A0		
	PTGLCSAS0R8K2B51B0	300	PTGLCSAS0R8K2B51A0	
Narrow Current Band 51V Series	PTGL4SAS100K3B51B0	500	PTGL4SAS100K3B51A0	1500
	PTGL5SAS6R8K3B51B0		PTGL5SAS6R8K3B51A0	
	PTGL7SAS3R3K3B51B0		PTGL7SAS3R3K3B51A0	
	PTGL9SAS2R2K3B51B0		PTGL9SAS2R2K3B51A0	
	PTGLCSAS1R2K3B51B0	300	PTGLCSAS1R2K3B51A0	
Narrow Current Band 60V Series	PTGL4SAS220K4B51B0	500	PTGL4SAS220K4B51A0	1500
	PTGL4SAS220K4N51B0		PTGL4SAS220K4N51A0	
	PTGL5SAS100K4B51B0		PTGL5SAS100K4B51A0	
	PTGL7SAS5R6K4B51B0		PTGL7SAS5R6K4B51A0	
	PTGL7SAS5R6K4N51B0		PTGL7SAS5R6K4N51A0	
	PTGL9SAS3R3K4B51B0	PTGL9SAS3R3K4B51A0		
	PTGLCSAS2R2K4B51B0	300	PTGLCSAS2R2K4B51A0	
Narrow Current Band 140V Series	PTGL4SAS560K6B51B0	500	PTGL4SAS560K6B51A0	1500
	PTGL5SAS270K6B51B0		PTGL5SAS270K6B51A0	
	PTGL7SAS150K6B51B0		PTGL7SAS150K6B51A0	
	PTGL9SAS120K6B51B0		PTGL9SAS120K6B51A0	
	PTGL9SAS7R6K6B51B0	300	PTGL9SAS7R6K6B51A0	
	PTGLCSAS4R7K6B51B0		PTGLCSAS4R7K6B51A0	

Continued on the following page. 

POSISTOR[®] Lead Type Package

Continued from the preceding page.

■ Taping Dimension (PTGL_A0 Series)

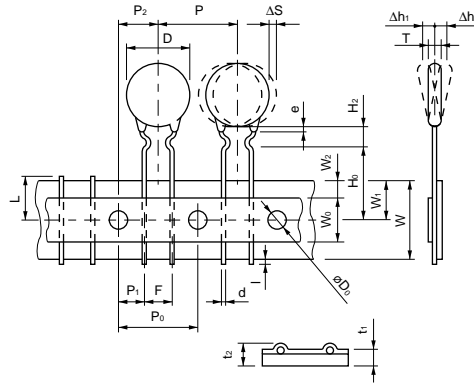

Item	Code	Dimensions (mm)	Note
Pitch of Component	P	12.7	Tolerance is determined by ΔS.
Pitch of Sprocket Hole	P ₀	12.7±0.3	
Lead Spacing	F	5.0 ^{+0.8} _{-0.3}	
Length from Hole Center to Lead	P ₁	3.85±0.8	
Length from Hole Center to Component Center	P ₂	6.35±1.3	Deviation in the feeding direction
Body Diameter	D	Please see in Ratings	
Body Thickness	T	Please see in Ratings	
Deviation along Tape, Left or Right Defect	ΔS	±1.5	Including the inclination caused by lead bending
Carrier Tape Width	W	18.0±0.5	
Position of Sprocket Hole	W ₁	9.0 ^{+0.5} _{-0.75}	Deviation of tape width
Lead Distance between Reference and Bottom Planes	H ₀	16.0±1.0	
	H ₂	6.0 max.	
Protrusion Length	l	+0.5 to -1.0	
Diameter of Sprocket Hole	D ₀	4.0±0.2	
Lead Diameter	d	Please see in Ratings	
Total Tape Thickness	t ₁	0.6±0.3	
Total Thickness of Tape and Lead Wire	t ₂	2.0 max.	
Deviation across Tape	Δh ₁ , Δh ₂	1.5 max.	
Portion to cut in Case of Defect	L	11.0 ⁺⁰ _{-2.0}	
Hold Down Tape Width	W ₀	11.0 min.	
Hold Down Tape Position	W ₂	4.0 max.	
Coating Extension on Lead	e	Up to the center of crimp	

△Note:

1. Export Control

<For customers outside Japan>

No Murata products should be used or sold, through any channels, for use in the design, development, production, utilization, maintenance or operation of, or otherwise contribution to (1) any weapons (Weapons of Mass Destruction [nuclear, chemical or biological weapons or missiles] or conventional weapons) or (2) goods or systems specially designed or intended for military end-use or utilization by military end-users.

<For customers in Japan>

For products which are controlled items subject to the "Foreign Exchange and Foreign Trade Law" of Japan, the export license specified by the law is required for export.

2. Please contact our sales representatives or product engineers before using the products in this catalog for the applications listed below, which require especially high reliability for the prevention of defects which might directly damage a third party's life, body or property, or when one of our products is intended for use in applications other than those specified in this catalog.

- | | |
|-----------------------------|--|
| ① Aircraft equipment | ② Aerospace equipment |
| ③ Undersea equipment | ④ Power plant equipment |
| ⑤ Medical equipment | ⑥ Transportation equipment (vehicles, trains, ships, etc.) |
| ⑦ Traffic signal equipment | ⑧ Disaster prevention / crime prevention equipment |
| ⑨ Data-processing equipment | ⑩ Application of similar complexity and/or reliability requirements to the applications listed above |

3. Product specifications in this catalog are as of March 2011. They are subject to change or our products in it may be discontinued without advance notice. Please check with our sales representatives or product engineers before ordering. If there are any questions, please contact our sales representatives or product engineers.

4. Please read rating and △CAUTION (for storage, operating, rating, soldering, mounting and handling) in this catalog to prevent smoking and/or burning, etc.

5. This catalog has only typical specifications because there is no space for detailed specifications. Therefore, please review our product specifications or consult the approval sheet for product specifications before ordering.

6. Please note that unless otherwise specified, we shall assume no responsibility whatsoever for any conflict or dispute that may occur in connection with the effect of our and/or a third party's intellectual property rights and other related rights in consideration of your use of our products and/or information described or contained in our catalogs. In this connection, no representation shall be made to the effect that any third parties are authorized to use the rights mentioned above under licenses without our consent.

7. No ozone depleting substances (ODS) under the Montreal Protocol are used in our manufacturing process.

 **Murata Manufacturing Co., Ltd.**

<http://www.murata.com/>

Head Office

1-10-1, Higashi Kotari, Nagaokakyo-shi, Kyoto 617-8555, Japan
Phone: 81-75-951-9111

International Division

3-29-12, Shibuya, Shibuya-ku, Tokyo 150-0002, Japan
Phone: 81-3-5469-6123 Fax: 81-3-5469-6155 E-mail: intl@murata.co.jp