

## FEATURES

### Dual output frequency range

 $f_{OUT} = 10.38 \text{ GHz to } 11.30 \text{ GHz}$ 
 $f_{OUT/2} = 5.19 \text{ GHz to } 5.65 \text{ GHz}$ 

### Power output ( $P_{OUT}$ ): 8 dBm

### Single-side band (SSB) phase noise

 $-86 \text{ dBc/Hz typical at } 10 \text{ kHz}$ 
 $-114 \text{ dBc/Hz typical at } 100 \text{ kHz}$ 

### No external resonator needed

### 32-lead, RoHS compliant, 5 mm × 5 mm LFCSP (25 mm<sup>2</sup>)

## APPLICATIONS

### Point to point and multipoint radios

### Test equipment and industrial controls

### Very small aperture terminals (VSATs)

## FUNCTIONAL BLOCK DIAGRAM

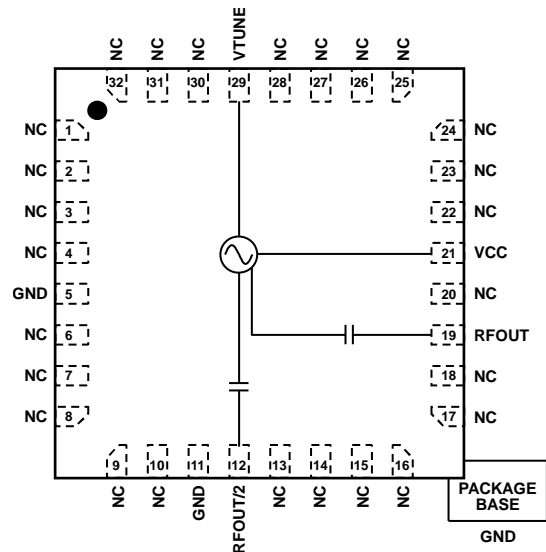

Figure 1.

## GENERAL DESCRIPTION

The HMC1164 is a monolithic microwave integrated circuit (MMIC), voltage controlled oscillator that integrates a resonator, a negative resistance device, and a varactor diode, and features a half frequency output.

Because of the monolithic construction of the oscillator, the output power and phase noise performance are excellent over temperature.

The power output is 8 dBm typical from a 5 V supply voltage. The voltage controlled oscillator is housed in a RoHS-compliant LFCSP package and requires no external matching components.

Rev. 0

[Document Feedback](#)

Information furnished by Analog Devices is believed to be accurate and reliable. However, no responsibility is assumed by Analog Devices for its use, nor for any infringements of patents or other rights of third parties that may result from its use. Specifications subject to change without notice. No license is granted by implication or otherwise under any patent or patent rights of Analog Devices. Trademarks and registered trademarks are the property of their respective owners.

One Technology Way, P.O. Box 9106, Norwood, MA 02062-9106, U.S.A.  
 Tel: 781.329.4700 ©2015 Analog Devices, Inc. All rights reserved.  
[Technical Support](#) [www.analog.com](http://www.analog.com)

**TABLE OF CONTENTS**

Features .....	1	Pin Configuration and Function Descriptions.....	5
Applications.....	1	Interface Schematics .....	6
Functional Block Diagram .....	1	Typical Performance Characteristics .....	7
General Description .....	1	Evaluation Printed Circuit Board (PCB).....	9
Revision History .....	2	Bill of Materials.....	9
Specifications.....	3	Packaging and Ordering Information .....	10
Absolute Maximum Ratings .....	4	Outline Dimensions.....	10
ESD Caution.....	4	Ordering Guide .....	10

**REVISION HISTORY**

5/15—Revision 0: Initial Version

## SPECIFICATIONS

$T_A = -40^{\circ}\text{C}$  to  $+85^{\circ}\text{C}$ ,  $V_{CC} = 5\text{ V}$ , unless otherwise noted.

Table 1.

Parameter	Min	Typ	Max	Unit	Test Conditions/Comments
FREQUENCY					
Range					
$f_{\text{OUT}}$	10.38		11.30	GHz	
$f_{\text{OUT}}/2$	5.19		5.65	GHz	
Drift Rate		1.0		MHz/ $^{\circ}\text{C}$	
Pulling		0.3		MHz p-p	Pulling into a 2.0:1 voltage standing wave ratio (VSWR)
Pushing		8.0		MHz/V	At $V_{\text{TUNE}} = 5\text{ V}$
POWER OUTPUT					
RFOUT	4	8	12	dBm	
RFOUT/2	4	8	12	dBm	
Supply Current ( $I_{\text{CC}}$ )		175		mA	$V_{\text{CC}} = 4.75\text{ V}$
	160	200	290	mA	$V_{\text{CC}} = 5.00\text{ V}$
		218		mA	$V_{\text{CC}} = 5.25\text{ V}$
HARMONICS, SUBHARMONICS					
Half		39		dBc	RFOUT
Second		20		dBc	
Third		30		dBc	
TUNING					
Voltage ( $V_{\text{TUNE}}$ )	2		13	V	
Sensitivity	80		300	MHz/V	
Tune Port Leakage Current			10	$\mu\text{A}$	$V_{\text{TUNE}} = 13\text{ V}$
OUTPUT RETURN LOSS (RFOUT)					
		3.5		dB	
SSB PHASE NOISE					
10 kHz Offset		-86	-82	dBc/Hz	
100 kHz Offset		-114	-110	dBc/Hz	

**ABSOLUTE MAXIMUM RATINGS**

Table 2.

Parameter	Rating
V <sub>CC</sub>	5.5 V dc
VTUNE	0 V to 15 V
Temperature	
Operating	−40°C to +85°C
Storage	−65°C to +150°C
Nominal Junction (to Maintain 1 Million Hours MTTF)	135°C
Nominal Junction (T <sub>A</sub> = 85°C)	111°C
Maximum Reflow Temperature (MSL3 Rating)	260°C
Thermal Resistance (Junction to Ground Paddle)	26°C/W
ESD Sensitivity (Human Body Model)	Class 1A

Stresses at or above those listed under Absolute Maximum Ratings may cause permanent damage to the product. This is a stress rating only; functional operation of the product at these or any other conditions above those indicated in the operational section of this specification is not implied. Operation beyond the maximum operating conditions for extended periods may affect product reliability.

**ESD CAUTION****ESD (electrostatic discharge) sensitive device.**

Charged devices and circuit boards can discharge without detection. Although this product features patented or proprietary protection circuitry, damage may occur on devices subjected to high energy ESD. Therefore, proper ESD precautions should be taken to avoid performance degradation or loss of functionality.

### PIN CONFIGURATION AND FUNCTION DESCRIPTIONS

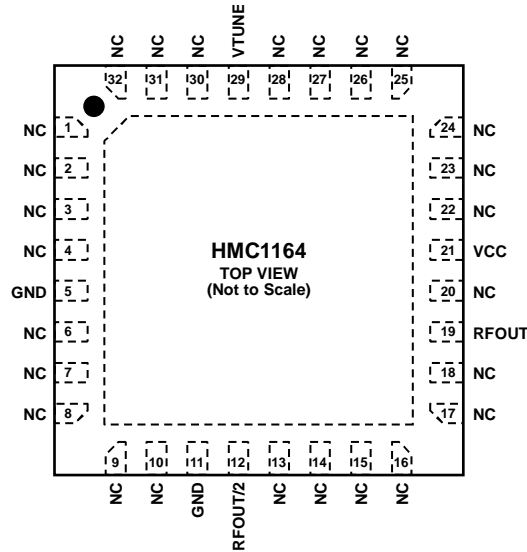

- NOTES**
1. NC = NO CONNECT. HOWEVER, THESE PINS MAY BE CONNECTED TO RF/DC GROUND WITHOUT AFFECTING THE PERFORMANCE OF THE DEVICE.
  2. THE EXPOSED PAD MUST BE CONNECTED TO RF/DC GROUND.

131153-002

Figure 2. Pin Configuration

Table 3. Pin Function Descriptions

Pin No.	Mnemonic	Description
1 to 4, 6 to 10, 13 to 18, 20, 22 to 28, 30 to 32	NC	No Connect. However, these pins can be connected to RF/dc ground without affecting the performance of the device.
5, 11	GND	Ground. Connect these pins to RF/dc ground.
12	RFOUT/2	Half Frequency Output. This pin is ac-coupled.
19	RFOUT	RF Output. This pin is ac-coupled.
21	VCC	Supply Voltage (5 V).
29	VTUNE	Control Voltage and Modulation Input. The modulation bandwidth is dependent on the drive source impedance.
	EP	Exposed Pad. The exposed metal pad must be connected to RF/dc ground.

INTERFACE SCHEMATICS

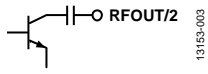

Figure 3. RFOUT/2 Interface

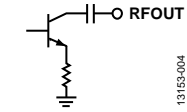

Figure 4. RFOUT Interface

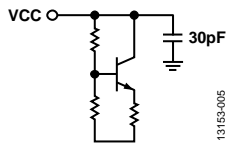

Figure 5. VCC Interface

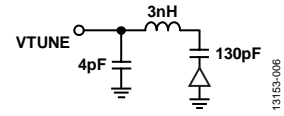

Figure 6. VTUNE Interface

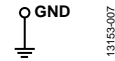

Figure 7. GND Interface

### TYPICAL PERFORMANCE CHARACTERISTICS

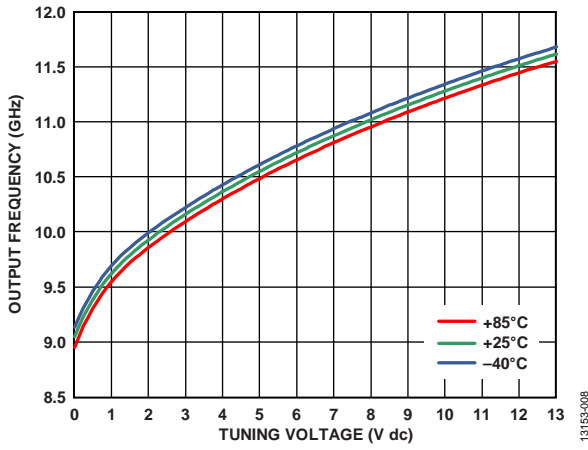

Figure 8. Output Frequency vs. Tuning Voltage ( $V_{TUNE}$ )

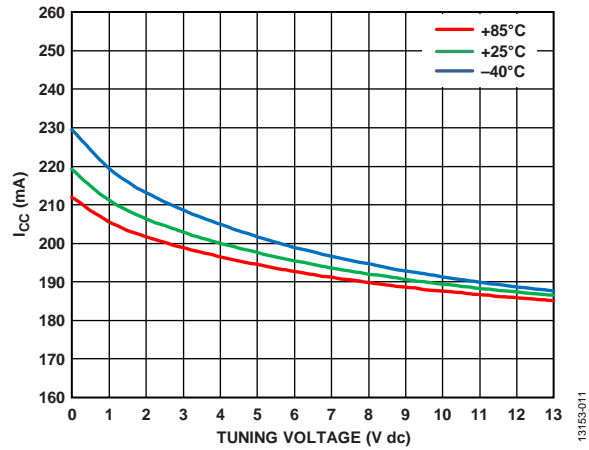

Figure 11. Supply Current ( $I_{CC}$ ) vs. Tuning Voltage ( $V_{TUNE}$ )

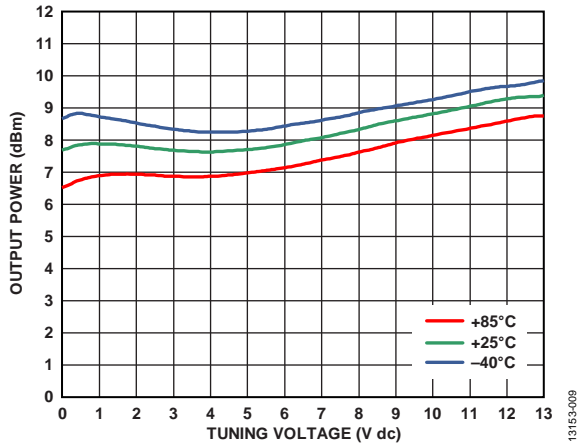

Figure 9. Output Power vs. Tuning Voltage ( $V_{TUNE}$ )

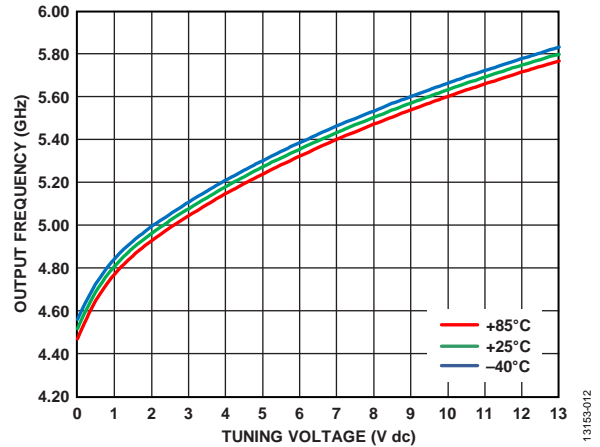

Figure 12. RFOUT/2 Output Frequency vs. Tuning Voltage ( $V_{TUNE}$ )

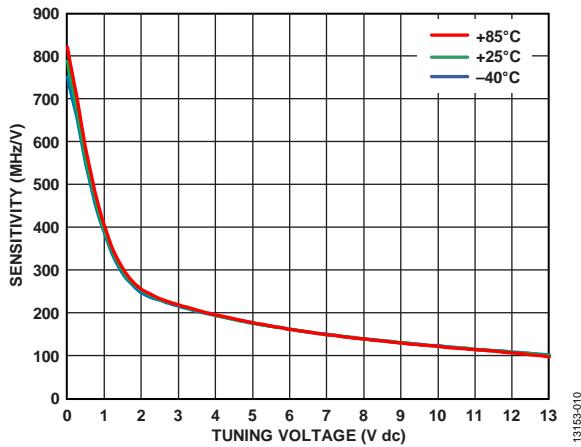

Figure 10. Sensitivity vs. Tuning Voltage ( $V_{TUNE}$ )

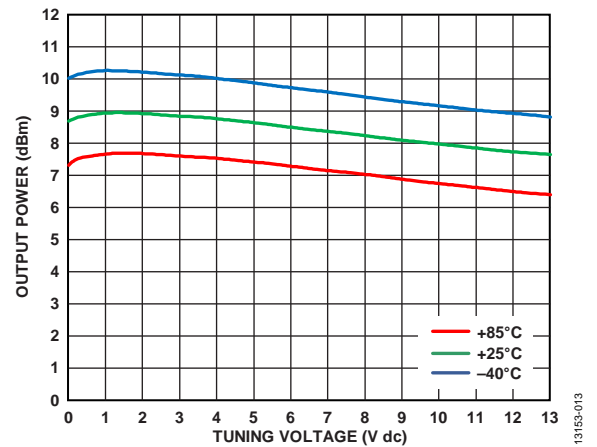

Figure 13. RFOUT/2 Output Power vs. Tuning Voltage ( $V_{TUNE}$ )

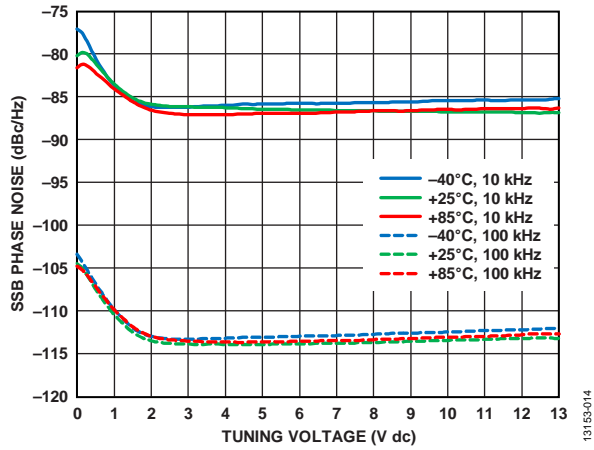

Figure 14. SSB Phase Noise vs. Tuning Voltage ( $V_{TUNE}$ )

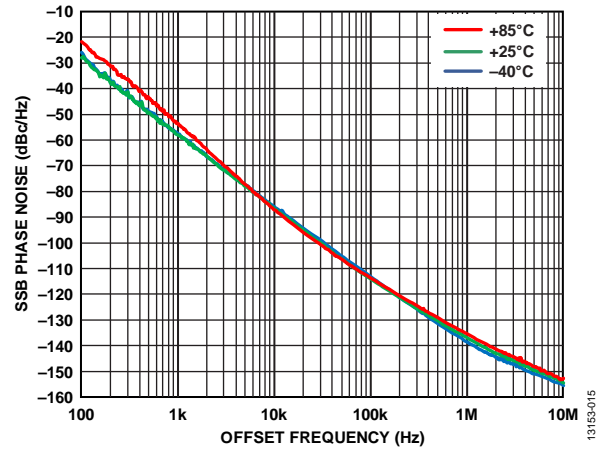

Figure 15. SSB Phase Noise vs. Offset Frequency at  $V_{TUNE} = 5 V$



## EVALUATION PRINTED CIRCUIT BOARD (PCB)

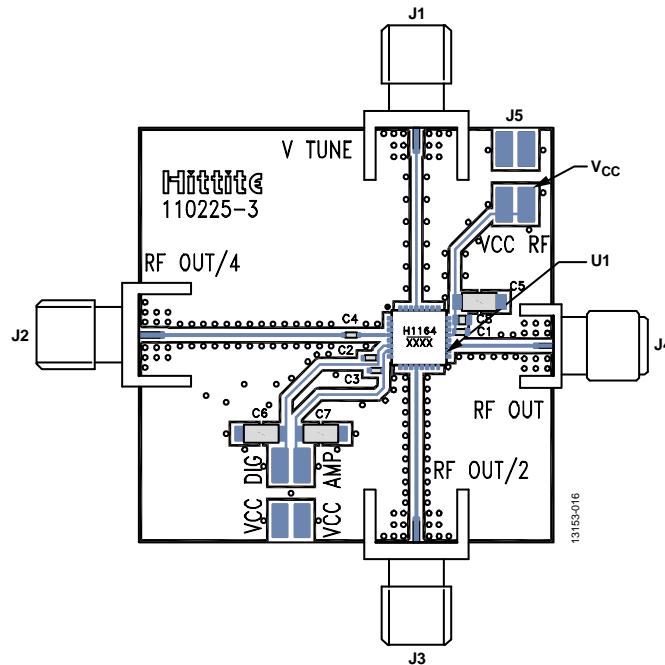

Figure 16. 110225-3 Evaluation PCB

The circuit board used in this application uses RF circuit design techniques. Ensure that signal lines have  $50\ \Omega$  impedance and connect the package ground leads and backside ground paddle directly to the ground plane.

Use a sufficient number of via holes to connect the top and bottom ground planes. The evaluation circuit board shown in Figure 16 is available from Analog Devices, Inc., upon request.

## BILL OF MATERIALS

Table 4. Bill of Materials for the EV1HMC1164LP5

Item	Description
J1 to J4	PCB mount SMA RF connectors
J5, J6	2 mm dc header
C1 to C3	100 pF capacitors, 0402 package
C4	1000 pF capacitor, 0402 package
C5 to C7	2.2 $\mu$ F tantalum capacitors
C8	0.01 $\mu$ F capacitor, 0603 package
U1	<a href="#">HMC1164LP5E</a> VCO
PCB <sup>1</sup>	110225-3 evaluation board <sup>2</sup>

<sup>1</sup> Circuit board material is Rogers 4350.

<sup>2</sup> Reference this number when ordering the complete evaluation PCB.

PACKAGING AND ORDERING INFORMATION

OUTLINE DIMENSIONS

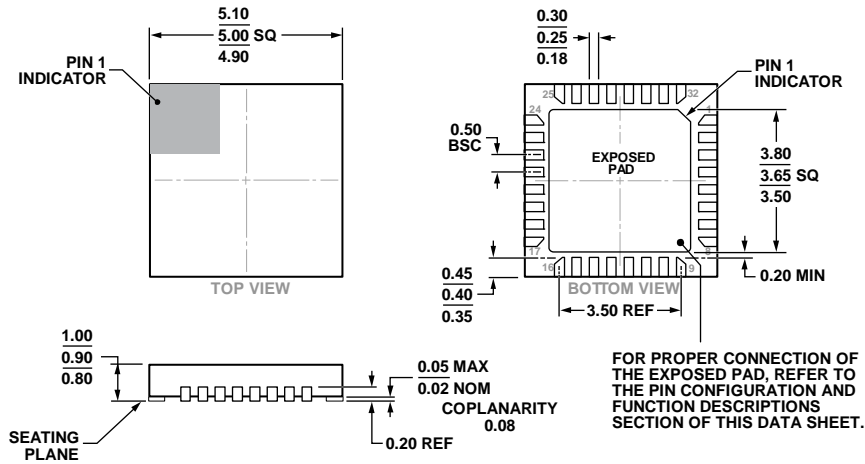

COMPLIANT TO JEDEC STANDARDS MO-220-VHHD-4.

Figure 17. 32-Lead Lead Frame Chip Scale Package [LFCSP\_VQ]  
 5 mm × 5 mm Body, Very Thin Quad  
 (HCP-32-1)  
 Dimensions shown in millimeters

ORDERING GUIDE

Model <sup>1</sup>	Temperature Range	MSL Rating <sup>2</sup>	Package Description	Package Option	Qty.	Branding <sup>3</sup>
HMC1164LP5E	-40°C to +85°C	MSL3	32-Lead LFCSP_VQ	HCP-32-1		H1164 XXXX
HMC1164LP5ETR	-40°C to +85°C	MSL3	32-Lead LFCSP_VQ, 7" Tape and Reel	HCP-32-1	500	H1164 XXXX
EV1HMC1164LP5			Evaluation Board			

<sup>1</sup> The HMC1164LP5E and HMC1164LP5ETR are RoHS-compliant parts.  
<sup>2</sup> See the Absolute Maximum Ratings section, Table 2.  
<sup>3</sup> XXXX is a placeholder for the 4-digit lot number.