

## DESCRIPTION

Demonstration circuit 1032A is a high power isolated synchronous forward converter featuring the LTC3725 and LTC3726. When powered from a 36-72V input, a single DC1032A provides an isolated 12V at 12A in a eight-brick footprint. The converter operates at 300kHz and achieves efficiency up to 94.0% with synchronous output rectifiers. Secondary-side control eliminates complex optocoupler feedback, providing fast transient response with a minimum amount of output capacitance. For other

output voltages see DC1031A-A/B/C (2.5V/3.3V/5V at 20A). For higher powers see DC888A-A/B/C (3.3V at 50A / 5V at 35A / 12V at 20A) which also support polyphase operation for even higher powers. The simple architecture can be easily modified to meet different input and output voltage requirements.

**Design files for this circuit board are available. Call the LTC factory.**

 , LTC and LT are registered trademarks of Linear Technology Corporation.

**Table 1. Performance Summary (T<sub>A</sub> = 25°C)**

PARAMETER	CONDITION	VALUE
Minimum Input Voltage		36V
Maximum Input Voltage		72V
Output Voltage V <sub>OUT</sub>	V <sub>IN</sub> = 36V to 72V, I <sub>OUT</sub> = 0A to 12A	12V
Maximum Output Current	200LFM	12A
Typical Output Ripple V <sub>OUT</sub>	V <sub>IN</sub> = 48V, I <sub>OUT</sub> = 12A, 300kHz	100mV <sub>P-P</sub>
Output Regulation	Over All Input Voltages and Output Currents	±1% (Reference)
Load Transient Response	Peak Deviation with 0A to 12A Load Step (10A/us)	±600mV
	Settling Time	50us
Nominal Switching Frequency		300kHz
Efficiency	V <sub>IN</sub> = 48V, I <sub>OUT</sub> = 12A	93% Typical
Isolation	BASIC	1500VDC
Approximate Size	Component Area x Top Component Height	2.3" x 0.9" x 0.34"

## OPERATING PRINCIPLES – SINGLE PHASE

The LTC3726 secondary side controller is used on the secondary and the LTC3725 smart driver with self-starting capability is used on the primary. When an input voltage is applied, the LTC3725 (U1 in Figure 14), which is powered through R29 and Q28, begins a controlled soft-start of the output voltage by switching MOSFETs Q8 and Q11. As the output voltage begins to rise, the LTC3726 secondary controller is powered up via Q27. The LTC3726 then assumes control of the output voltage by sending encoded

PWM gate pulses to the LTC3725 primary driver via signal transformer, T2. The LTC3725 then operates as a simple driver receiving both input signals and bias power through T2. The transition from primary to secondary control occurs seamlessly. From that point on, operation and design simplifies to that of a simple buck converter. The LTC3726 regulates by observing the output voltage directly resulting in superior output voltage regulation and transient response.

## QUICK START PROCEDURE

Demonstration Circuit 1032A is easy to set up to evaluate the performance of the LTC3725 and LTC3726. Refer to Figure 1 for proper equipment setup. Follow the procedure below:

**NOTE:** When measuring the input or output voltage ripple, care must be taken to avoid a long ground lead on the scope probe. Measure the output (or input) voltage ripple by touching the probe tip and probe ground directly across the +Vout and -Vout (or +Vin and -Vin) terminals. See 0 for proper scope probe technique.

1. The optional input LC filter stage (C2/L1) lowers ac input rms current. A power supply's complete input filter must have output impedance that is less than the converter input impedance to assure stability. This may require a damping impedance. (See Linear Technology Application Note AN19 for a discussion of input filter stability.) A source with a 50mOhm or higher ESR at the filter resonant frequency is one way of providing damping for the filter elements provided on the DC1032A. For bench testing, adding an 82uF electrolytic capacitor such as a Sanyo 100ME82AX to the input terminals will provide suitable damping and ripple current capability. The values selected have a filter resonant frequency that is below the converter switching frequency, thus avoiding high circulating currents in the filter.
2. Set an input power supply to a voltage of 36V. Make sure that it is capable of 36V to 72V at a current supplying capability of at least 5A. Then, turn off the supply.
3. With power off, connect the supply to the input terminals +Vin and -Vin.
  - a. Input voltages lower than 36V can keep the converter from turning on due to the undervoltage lockout feature of the LTC3725.
  - b. If efficiency measurements are desired, an ammeter capable of measuring at least 5A<sub>dc</sub> per phase can be put in series with the input supply in order to measure the DC1032A's input current.
4. Turn on the power at the input.

**NOTE:** Make sure that the input voltage • 72V.
5. Check for the proper output voltage of 12V.
6. Turn off the power at the input.
7. Once the proper output voltages are established, connect a variable load capable of sinking 12A at 12V to the output terminals +Vout and -Vout. Set current to 0A.
  - a. If efficiency measurements are desired, an ammeter or a resistor current shunt that is capable of handling at least 12A<sub>dc</sub> can be put in series with the output load in order to measure the DC1032A's output current.
  - b. A voltmeter with a capability of measuring at least 12V can be placed across the output terminals in order to get an accurate output voltage measurement.
8. Turn on the power at the input.

**NOTE:** If there is no output, disconnect the load to verify that the load is not set too high.
9. Once the proper output voltage is established, adjust the load within the operating range and observe the output voltage regulation, ripple voltage, efficiency and other desired parameters.

# QUICK START GUIDE FOR DEMONSTRATION CIRCUIT 1032A

## 36V-72VIN, ISOLATED SYNCHRONOUS FORWARD

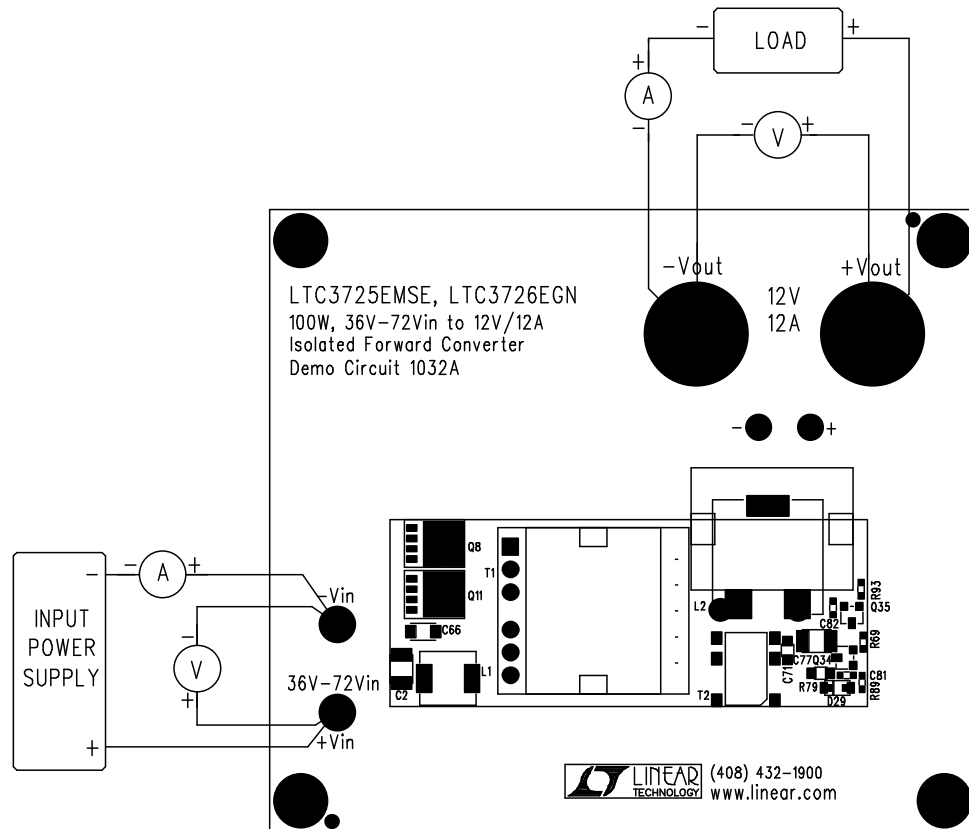

Figure 1. Proper Measurement Equipment Setup

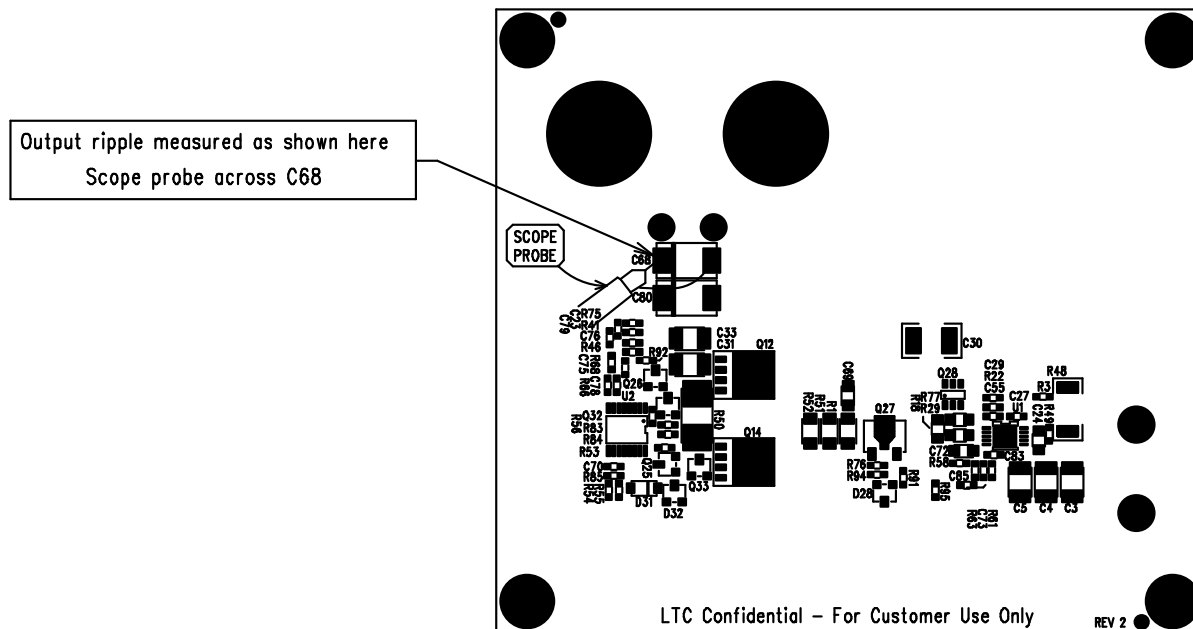

Figure 2. Measuring Input or Output Ripple

### MEASURED DATA

Figures 3 through 13 are measured data for a typical DC1032A. Figures 14 through 23 consist of schematics, bill of materials, and layout.

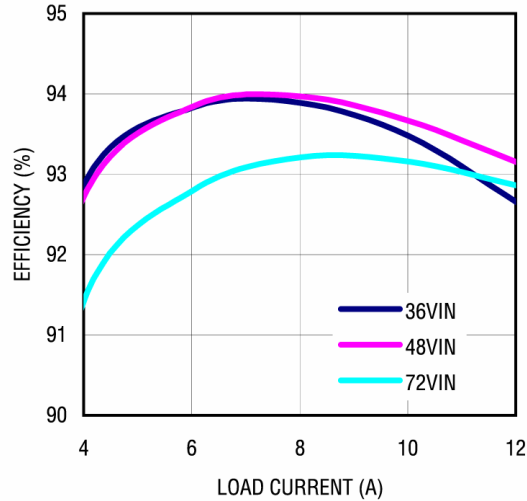

Figure 3. Efficiency

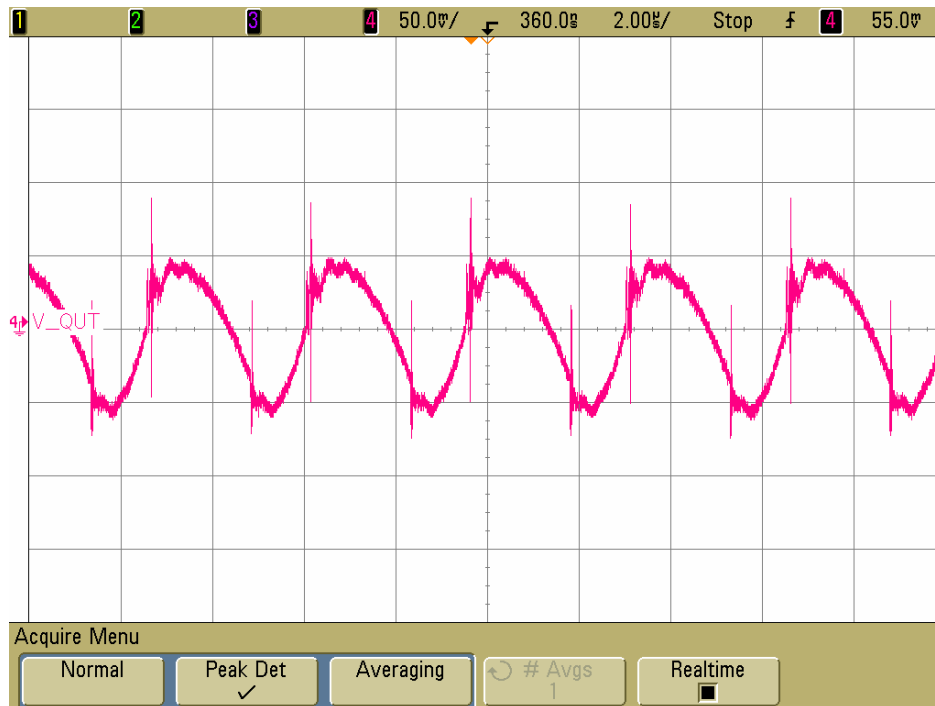

Figure 4. Output Voltage Ripple (72Vin, 12Aout)

# QUICK START GUIDE FOR DEMONSTRATION CIRCUIT 1032A

## 36V-72VIN, ISOLATED SYNCHRONOUS FORWARD



Figure 5. Load Transient Response (48Vin, 0A to 12Aout)

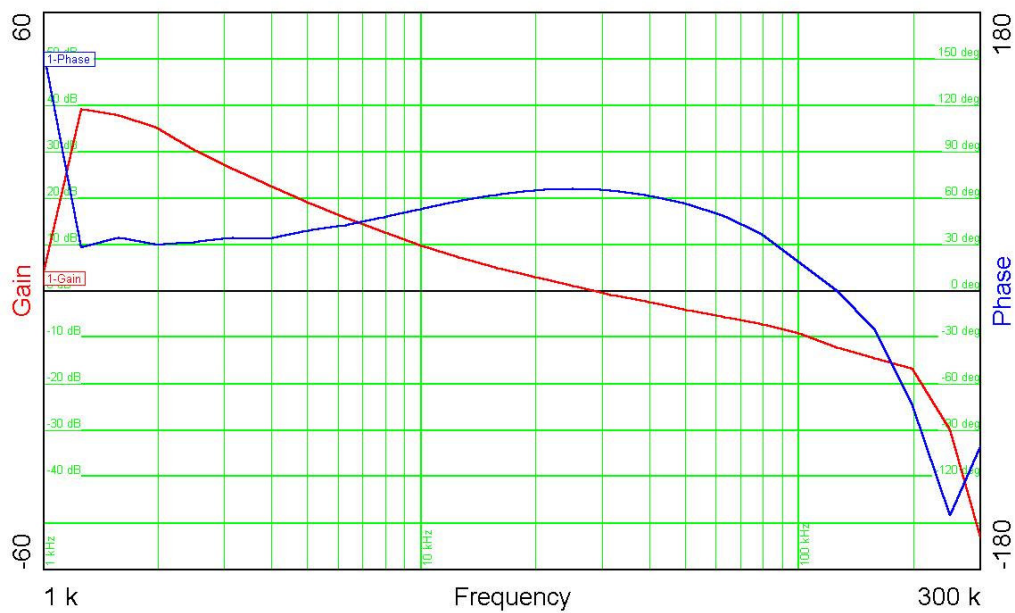

Figure 6. Loop Response (48Vin, 12Aout)

# QUICK START GUIDE FOR DEMONSTRATION CIRCUIT 1032A

## 36V-72VIN, ISOLATED SYNCHRONOUS FORWARD

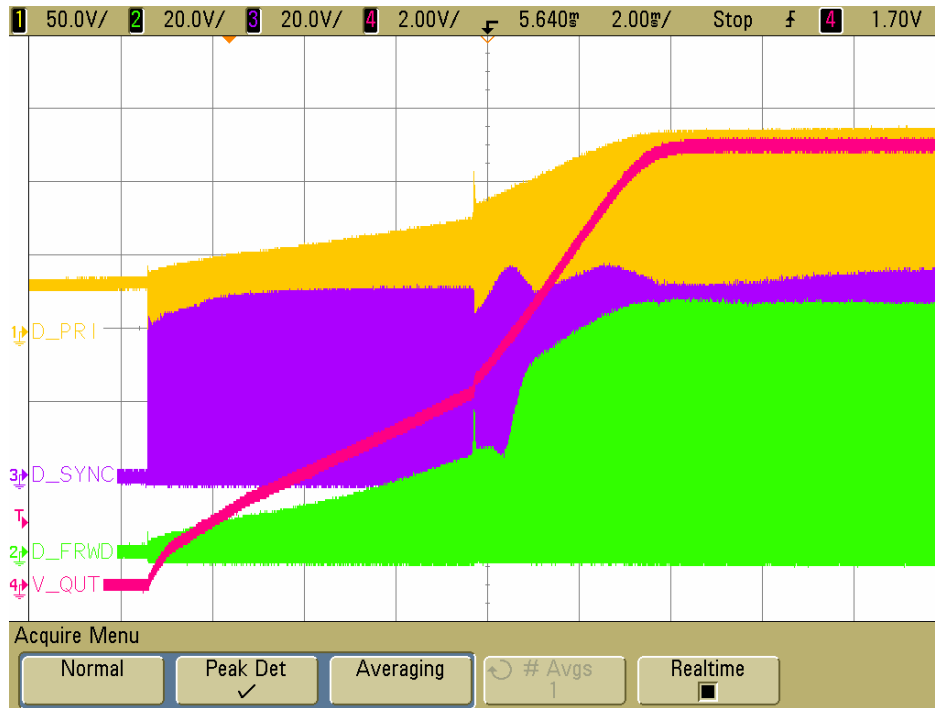

Figure 7. Turn-on (48Vin, 12Aout)

# QUICK START GUIDE FOR DEMONSTRATION CIRCUIT 1032A

## 36V-72VIN, ISOLATED SYNCHRONOUS FORWARD

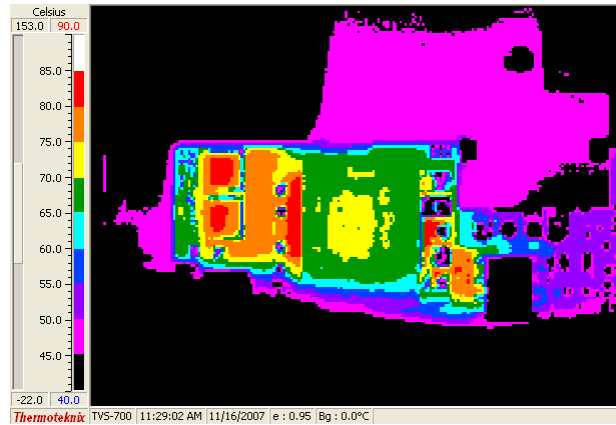

Figure 8. Temp Data (36Vin, 12Aout, 25°C, 200LFM airflow – front)



Figure 9. Temp Data (36Vin,12Aout, 25°C, 200LFM airflow – back)

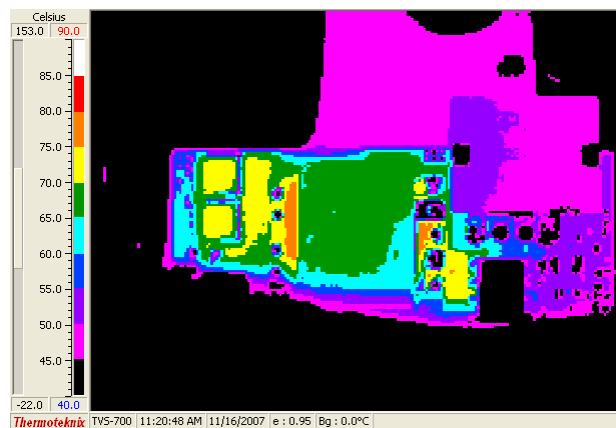

Figure 10. Temp Data (48Vin, 12Aout, 25°C, 200LFM airflow – front)

# QUICK START GUIDE FOR DEMONSTRATION CIRCUIT 1032A

## 36V-72VIN, ISOLATED SYNCHRONOUS FORWARD

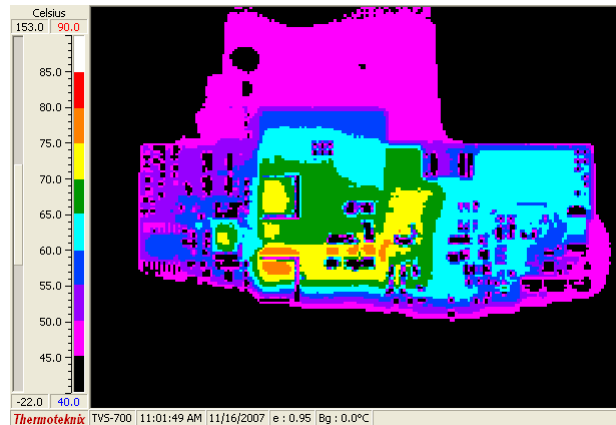

Figure 11. Temp Data (48Vin, 12Aout, 25°C, 200LFM airflow – back)

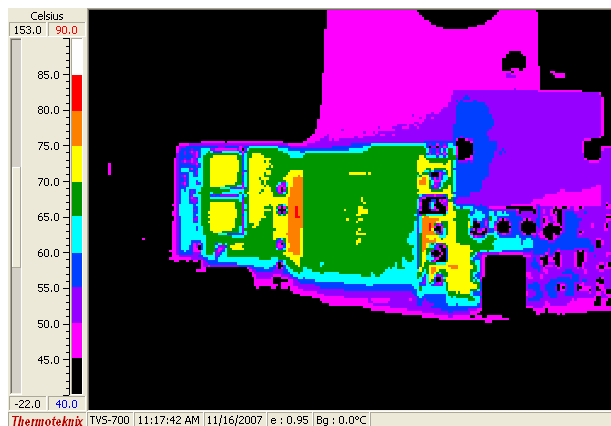

Figure 12. Temp Data (72Vin, 12Aout, 25°C, 200LFM airflow – front)



Figure 13. Temp Data (72Vin, 12Aout, 25°C, 200LFM airflow – back)



# QUICK START GUIDE FOR DEMONSTRATION CIRCUIT 1032A

## 36V-72VIN, ISOLATED SYNCHRONOUS FORWARD

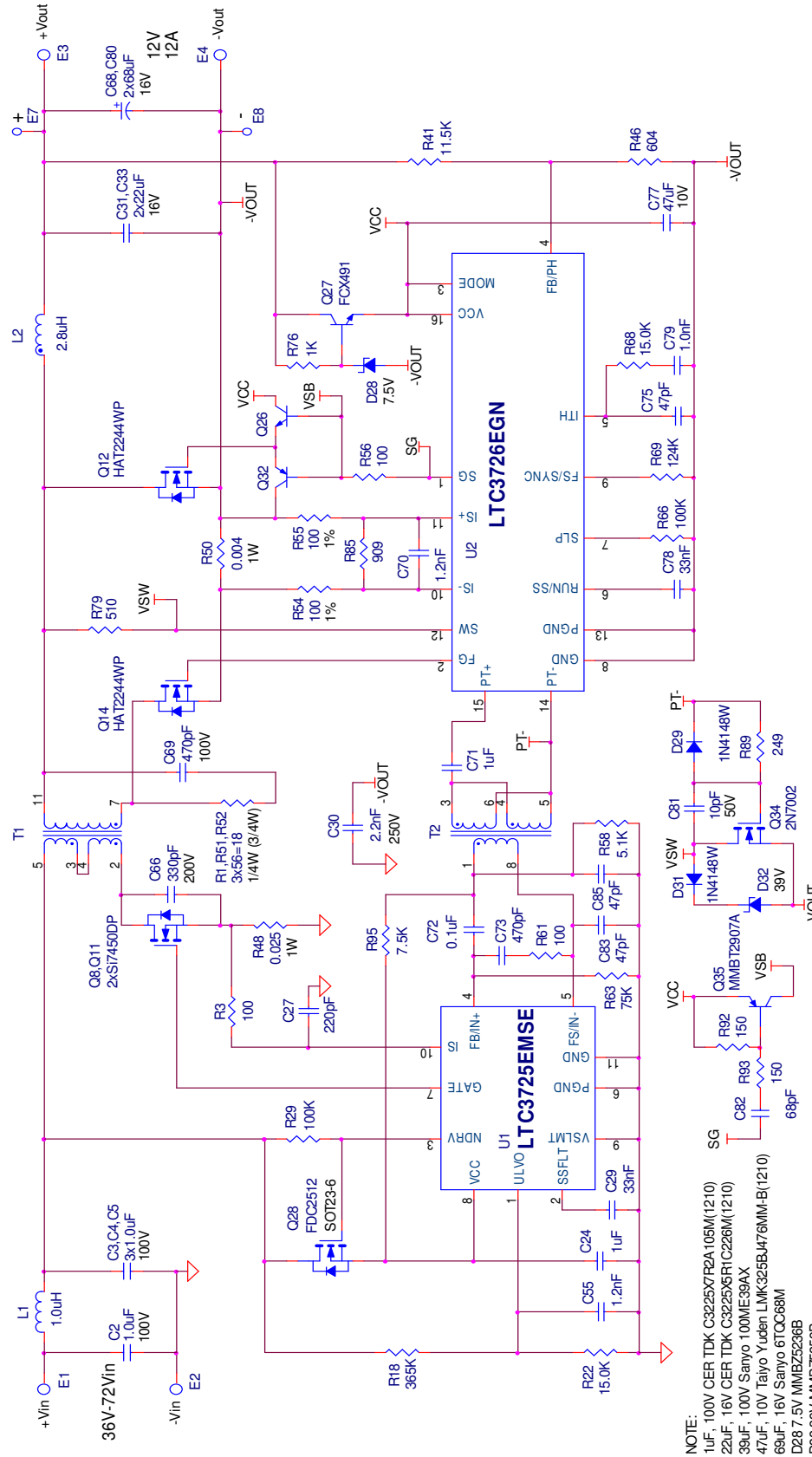

Figure 14. Schematic (optional components not shown).

# QUICK START GUIDE FOR DEMONSTRATION CIRCUIT 1032A

## 36V-72VIN, ISOLATED SYNCHRONOUS FORWARD

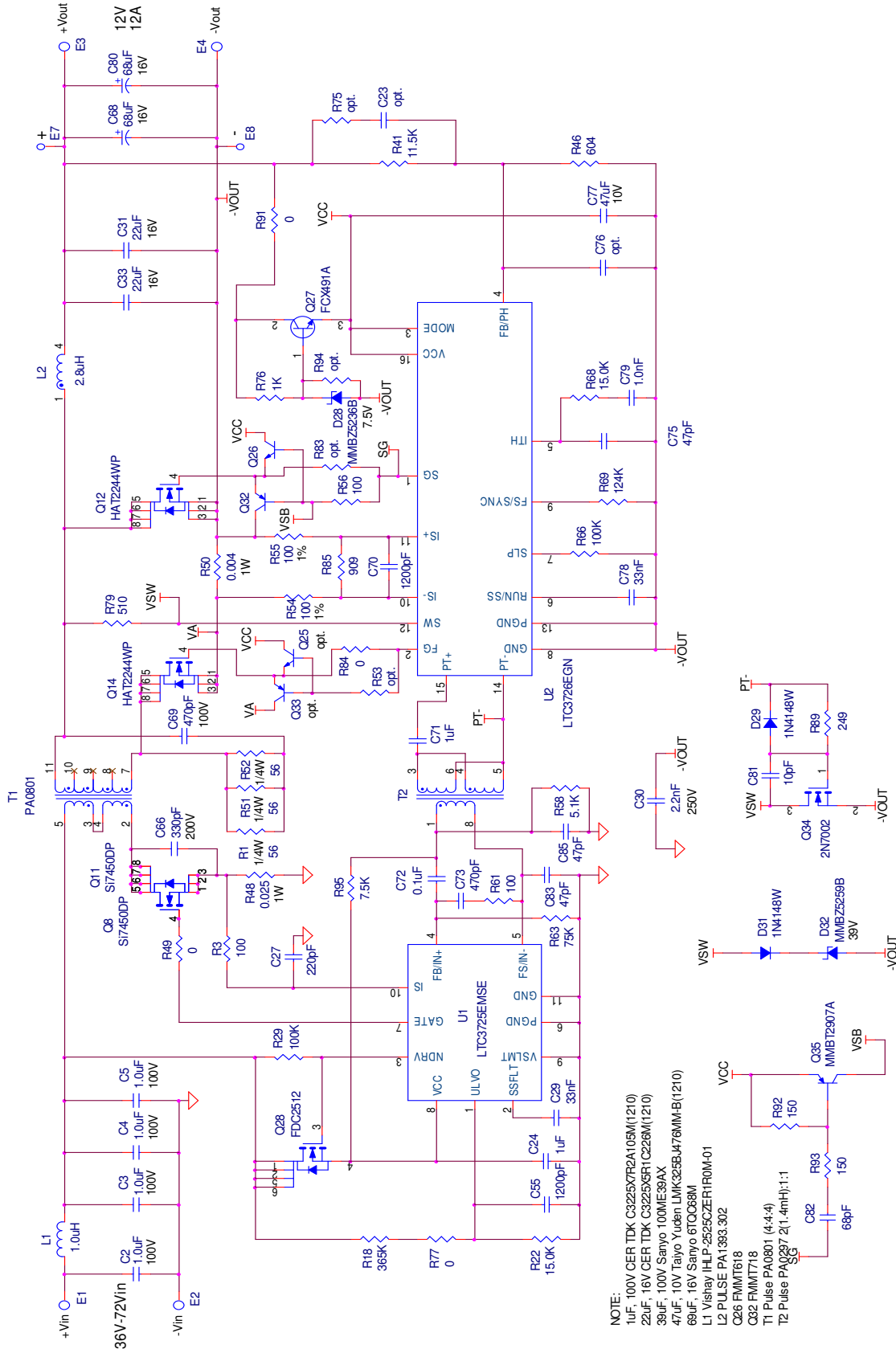

Figure 15. Full Schematic (optional components shown).

# QUICK START GUIDE FOR DEMONSTRATION CIRCUIT 1032A

## 36V-72VIN, ISOLATED SYNCHRONOUS FORWARD

Item	Qty	Reference	Part Description	Manufacture / Part #
<b>REQUIRED CIRCUIT COMPONENTS'</b>				
1	4	C2,C3,C4,C5	CAP., X7R, 1.0uF, 100V, 20%, 1210	TDK, C3225X7R2A105M
2	2	C71,C24	CAP., X7R, 1uF, 16V 10%, 0805	TAIYO YUDEN, EMK212BJ105KG
3	1	C27	CAP., X7R, 220pF, 25V, 10%, 0603	AVX, 06033C221KAT2A
4	2	C29,C78	CAP., X7R, 33nF, 25V, 10%, 0603	AVX, 06033C333KAT2A
5	1	C30	CAP., X7R, 2.2nF, 250V, 10%, 1812	MURATA, GA343QR7GD222KW01L
6	2	C31,C33	CAP., X5R, 22uF, 16V, 20%, 1210	TDK, C3225X5R1C226M
7	1	C69	CAP., COG, 470pF, 100V, 10%, 0805	AVX, 08051A471KAT2A
8	1	C73	CAP., COG, 470pF, 25V, 10%, 0603	AVX, 06033A471KAT2A
9	1	C66	CAP., COG, 330pF, 200V, 10%, 1206	AVX, 12062A331KAT2A
10	2	C68,C80	CAP., POSCAP, 68uF, 16V, 20% 7343	SANYO, 16TQC68M
11	2	C55,C70	CAP., X7R, 1200pF, 50V, 10%, 0603	AVX, 06035C122KAT2A
12	1	C72	CAP., X7R, 0.1uF, 25V, 10%, 0805	AVX, 08053C104KAT2A
13	3	C75,C83,C85	CAP., COG, 47pF, 25V, 10%, 0603	AVX, 06033A470KAT2A
14	1	C77	CAP., X7S, 47uF, 10V, 20%, 1210	TAIYO YUDEN, LMK325BJ476MM-TQ
15	1	C79	CAP., X7R, 1.0nF, 50V, 10%, 0603	AVX, 06035C102KAT2A
16	1	C81	CAP., COG, 10pF, 50V, 10%, 0603	AVX, 06035A100KAT2A
17	1	C82	CAP., COG, 68pF, 25V, 10%, 0603	AVX, 06033A680KAT2A
18	1	D28	DIODE, MMBZ5236B, SOT23	DIODES INC., MMBZ5236B
19	2	D29,D31	DIODE, 1N4148W, SOD-123	DIODES INC., 1N4148W-7-F
20	1	D32	DIODE, MMBZ5259B, SOT23	DIODES INC., MMBZ5259B
21	1	L1	INDUCTOR, 1.0uH	VISHAY DALE, IHLP2525CZER1R0M01
22	1	L2	INDUCTOR, 2.8uH	PULSE, PA1393.302
23	2	Q8,Q11	FET, N-CH., Si7450DP, POWERPAK SO-8	VISHAY, Si7450DP
24	2	Q12,Q14	FET, N-CH., HAT2244WP, WPAK	RENESAS, HAT2244WP-EL-E
25	1	Q26	NPN TRANSISTOR, SOT23	ZETEX, FMMT618
26	1	Q27	NPN TRANSISTOR, FCX491A	ZETEX, FCX491A
27	1	Q28	N-CH FET, 150V, FDC2512, SuperSOT-6	FAIRCHILD, FDC2512
28	1	Q32	PNP TRANSISTOR, SOT23	ZETEX, FMMT718
29	1	Q34	N-FET, 2N7002 SOT23	ZETEX, 2N7002
30	1	Q35	PNP TRANSISTOR, SOT23	DIODES., MMBT2907A-7-F
31	3	R3,R56,R61	RES., CHIP, 100, 1/16W, 5%, 0603	AAC, CR16-101JM
32	1	R18	RES., CHIP, 365K, 1/8W, 1%, 0805	AAC, CR10-3653FM
33	2	R22,R68	RES., CHIP, 15.0K, 1/16W, 1%, 0603	AAC, CR16-1502FM
34	1	R29	RES., CHIP, 100K, 1/8W, 5%, 0805	AAC, CR10-104JM
35	1	R41	RES., CHIP, 11.5K, 1/16W, 1%, 0603	AAC, CR16-1152FM
36	1	R46	RES., CHIP, 604, 1/16W, 1%, 0603	AAC, CR16-6040FM
37	1	R48	RES., CHIP, 0.025, 1W, 2%, 2010	IRC, LRC-LRF2010-01-R025-G
38	1	R50	RES., CHIP, 0.004, 1W, 1%, 2512	PANASONIC, ERJM1WSF4M0U
39	3	R1,R51,R52	RES., CHIP, 56, 1/4W, 5%, 1206	VISHAY, CRCW120656R0JNEA
40	2	R54,R55	RES., CHIP, 100, 1/16W, 1%, 0603	VISHAY, CRCW0603100RFKEA
41	1	R58	RES., CHIP, 5.1K, 1/16W, 5%, 0603	AAC, CR16-512JM
42	1	R63	RES., CHIP, 75K, 1/16W, 5%, 0603	VISHAY, CRCW060375K0JNEA
43	1	R66	RES., CHIP, 100K, 1/16W, 5%, 0603	AAC, CR16-104JM
44	1	R69	RES., CHIP, 124K, 1/16W, 1%, 0603	AAC, CR16-1243FM
45	1	R76	RES., CHIP, 1.0K, 1/4W, 5%, 0603	VISHAY, CRCW06031K00JNEA
46	1	R79	RES., CHIP, 510, 1/8W, 5%, 0805	VISHAY, CRCW0805510RJNEA

# QUICK START GUIDE FOR DEMONSTRATION CIRCUIT 1032A

## 36V-72VIN, ISOLATED SYNCHRONOUS FORWARD

47	1	R85	RES., CHIP, 909, 1/16W, 1%, 0603	VISHAY, CRCW0603909RFKEA
48	1	R89	RES., CHIP, 249, 1/16W, 1%, 0603	VISHAY, CRCW0603249RFKEA
49	2	R92,R93	RES., CHIP, 150, 1/16W, 5%, 0603	VISHAY, CRCW0603150RJNEA
50	1	R95	RES., CHIP, 7.5K, 1/16W, 5%, 0603	VISHAY, CRCW06037K50JNEA
51	1	T1	TRANSFORMER, PA0801	PULSE, PA0801
52	1	T2	TRANSFORMER, PA0297	PULSE, PA0297
53	1	U1	I.C., LTC3725EMSE, EMSE	LINEAR TECH., LTC3725EMSE#PBF
54	1	U2	I.C., LTC3726EGN SSOP16GN	LINEAR TECH., LTC3726EGN
<b>ADDITIONAL DEMO BOARD CIRCUIT COMPONENTS<sup>2</sup></b>				
1	0	C23,C76 (OPT.)	CAP., 0603	
2	0	Q25,Q33 (OPT.)	NPN/PNP Transistor, SOT23	
3	3	R49,R84,R91	RES., CHIP, 0, 1/16W, 0603	AAC, CR16-000M
4	0	R53,R75,R83,R94 (OPT.)	RES., CHIP, 0603	
5	1	R77	RES., CHIP, 0, 1/8W, 1%, 0805	AAC, CR10-0000FM
<b>HARDWARE-FOR DEMO BOARD ONLY:</b>				
1	2	E1,E2	TESTPOINT, TURRET, .094"	MILL-MAX, 2501-2
2	2	E8,E7	TESTPOINT, TURRET, .061"	MILL-MAX, 2308-2-00-44
3	2	E3,E4	STUD	PEM, KFH-032-10
4	4	E3,E4 (2 EACH)	NUT, BRASS, #10-32	ANY
5	2	E3,E4	Ring, Lug Ring #10	KESTONE, 8205
6	2	E3,E4	WAHSER, STAR #10 BRASS NICKEL	ANY
7	4	(STAND-OFF)	STAND-OFF, NYLON 0.5"	KEYSTONE, 8833(SNAP ON)
<b>Notes:</b>				
1. Required Circuit Components are those parts that are required to implement the circuit function				
2. Additional Demo Board Circuit Components are those parts that provide added functionality for the demo board but are not required in the actual circuit.				

**Figure 16. Bill of Materials**

# QUICK START GUIDE FOR DEMONSTRATION CIRCUIT 1032A

## 36V-72VIN, ISOLATED SYNCHRONOUS FORWARD

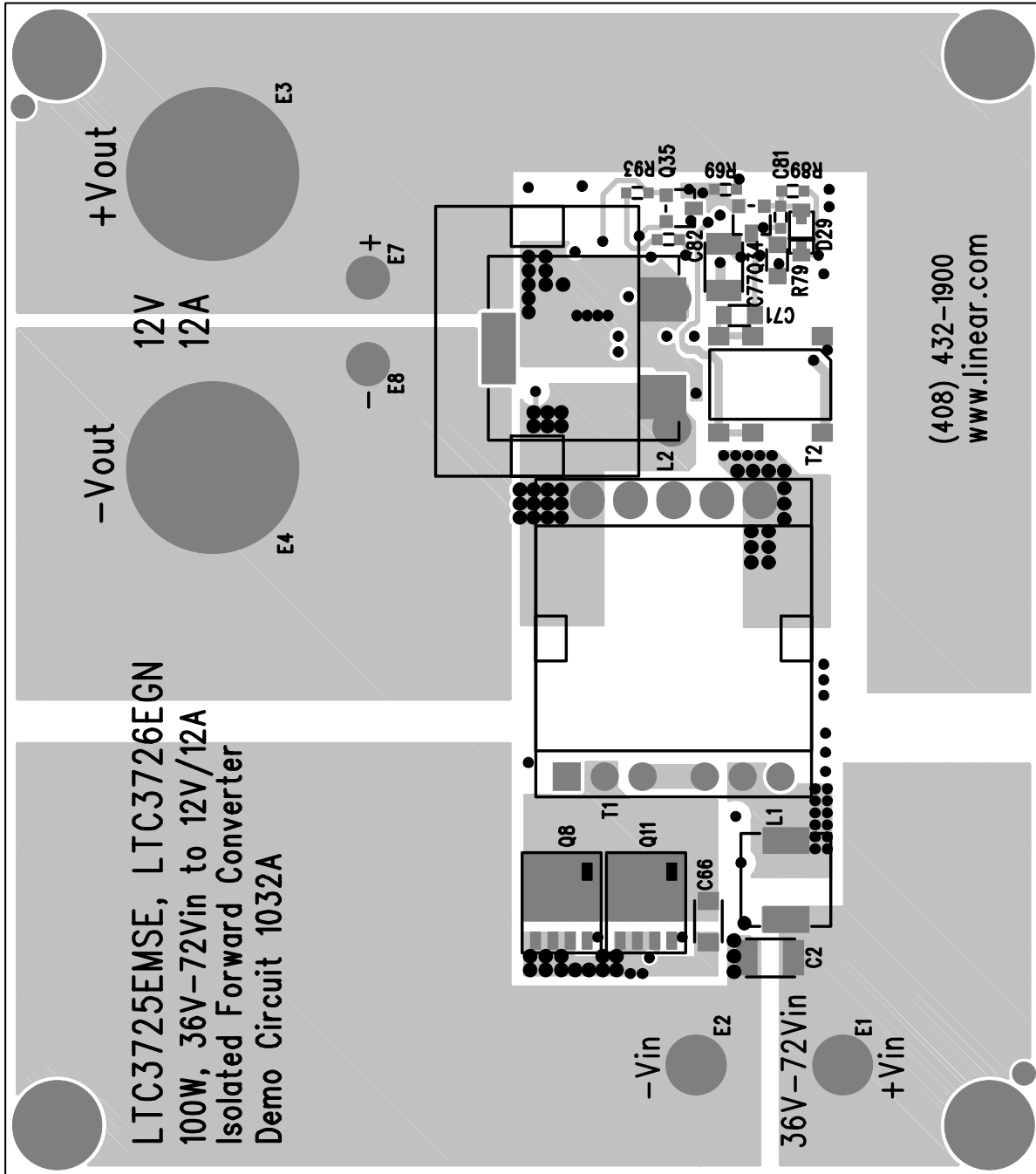

Figure 17. Top

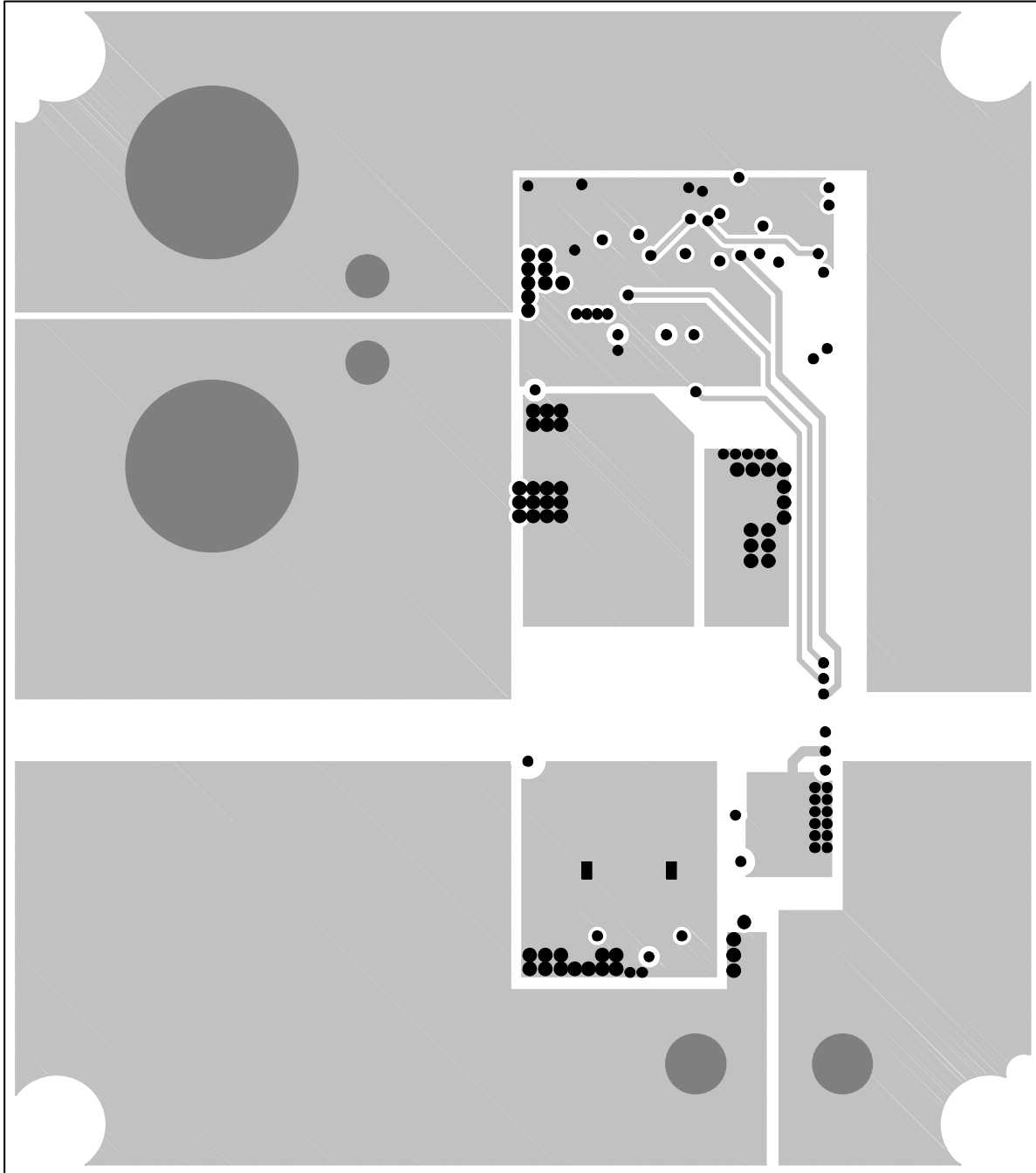

Figure 18. Layer 2

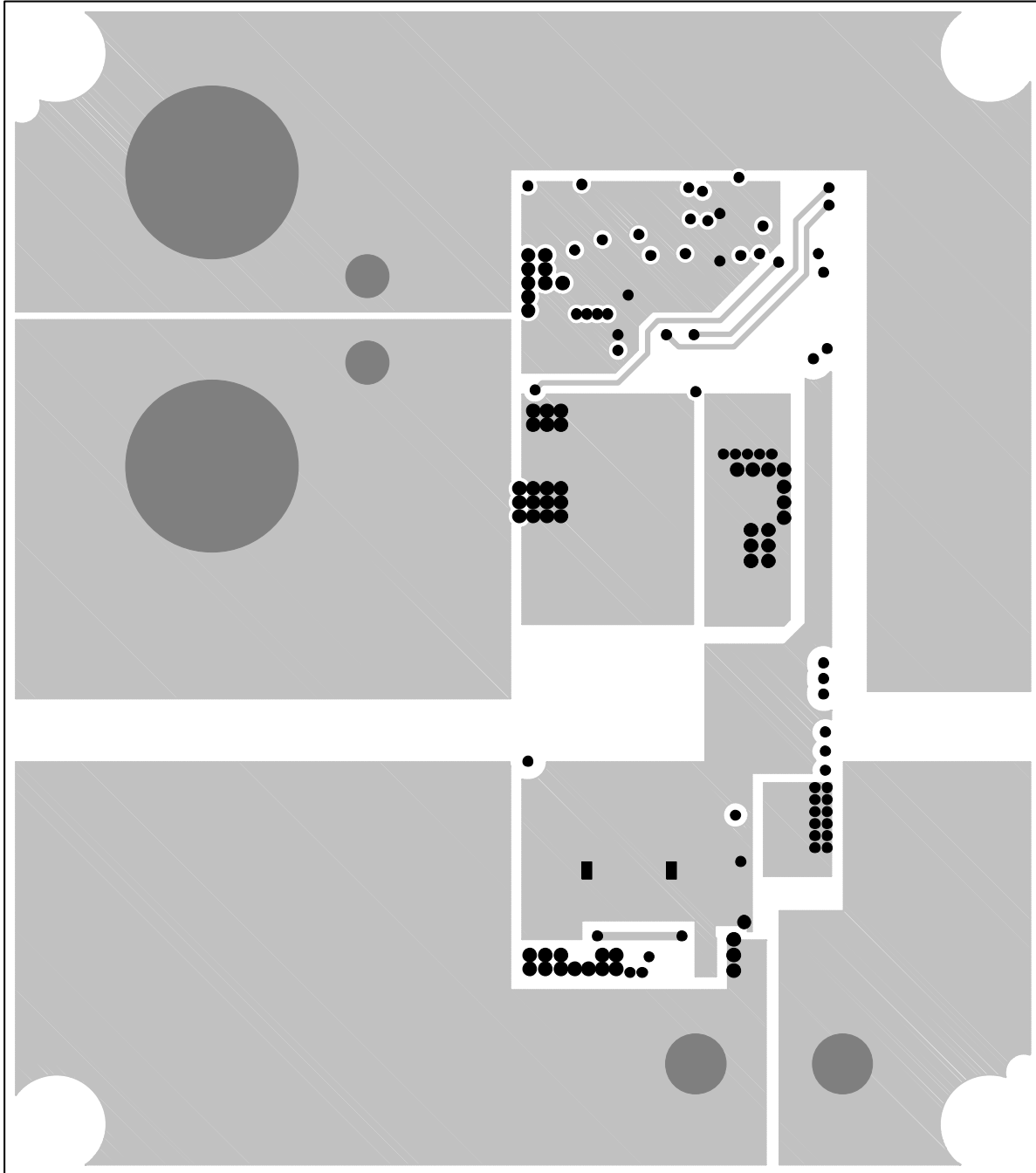

Figure 19. Layer 3



Figure 20. Layer 4



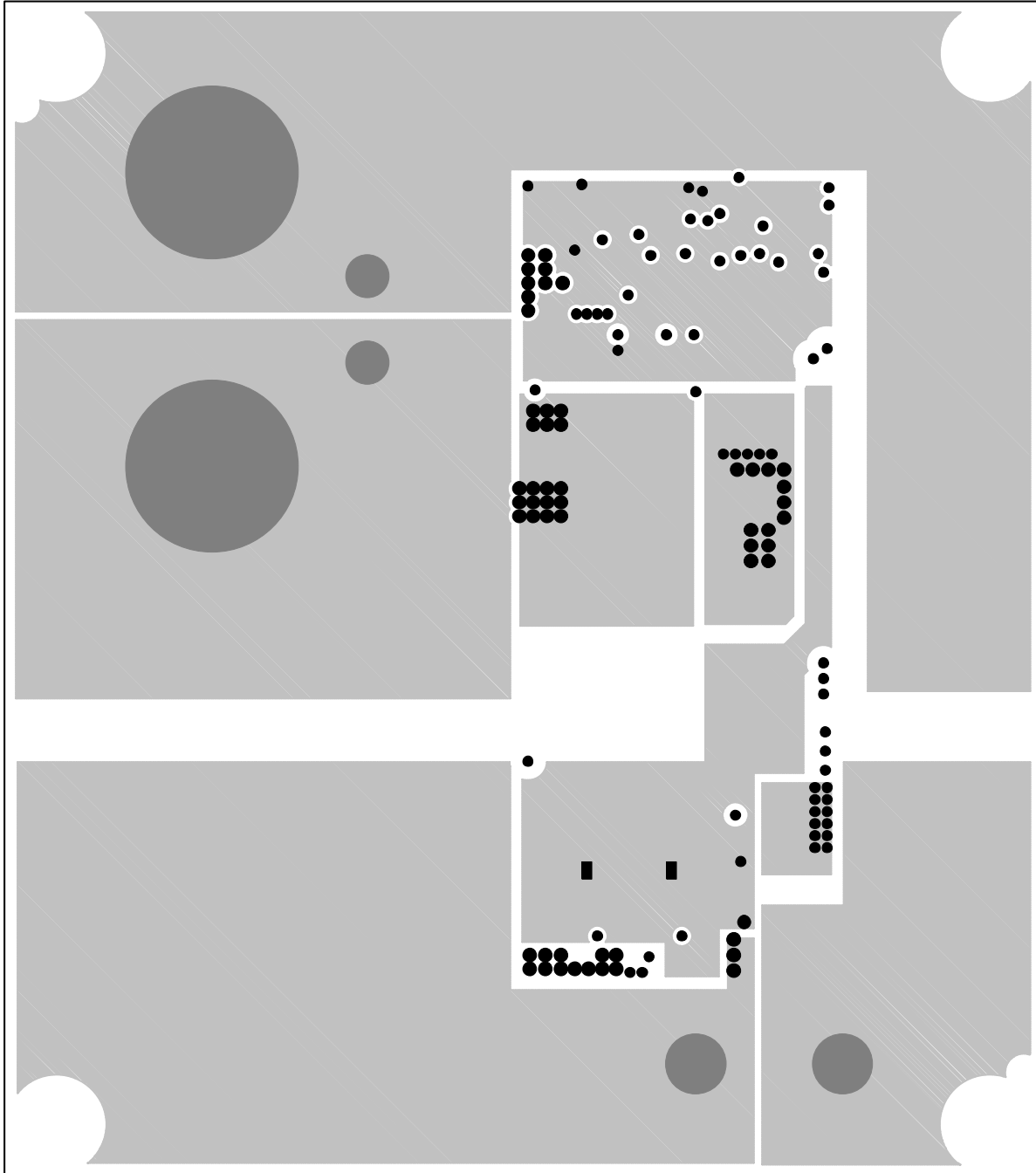

Figure 21. Layer 5

# QUICK START GUIDE FOR DEMONSTRATION CIRCUIT 1032A

## 36V-72VIN, ISOLATED SYNCHRONOUS FORWARD

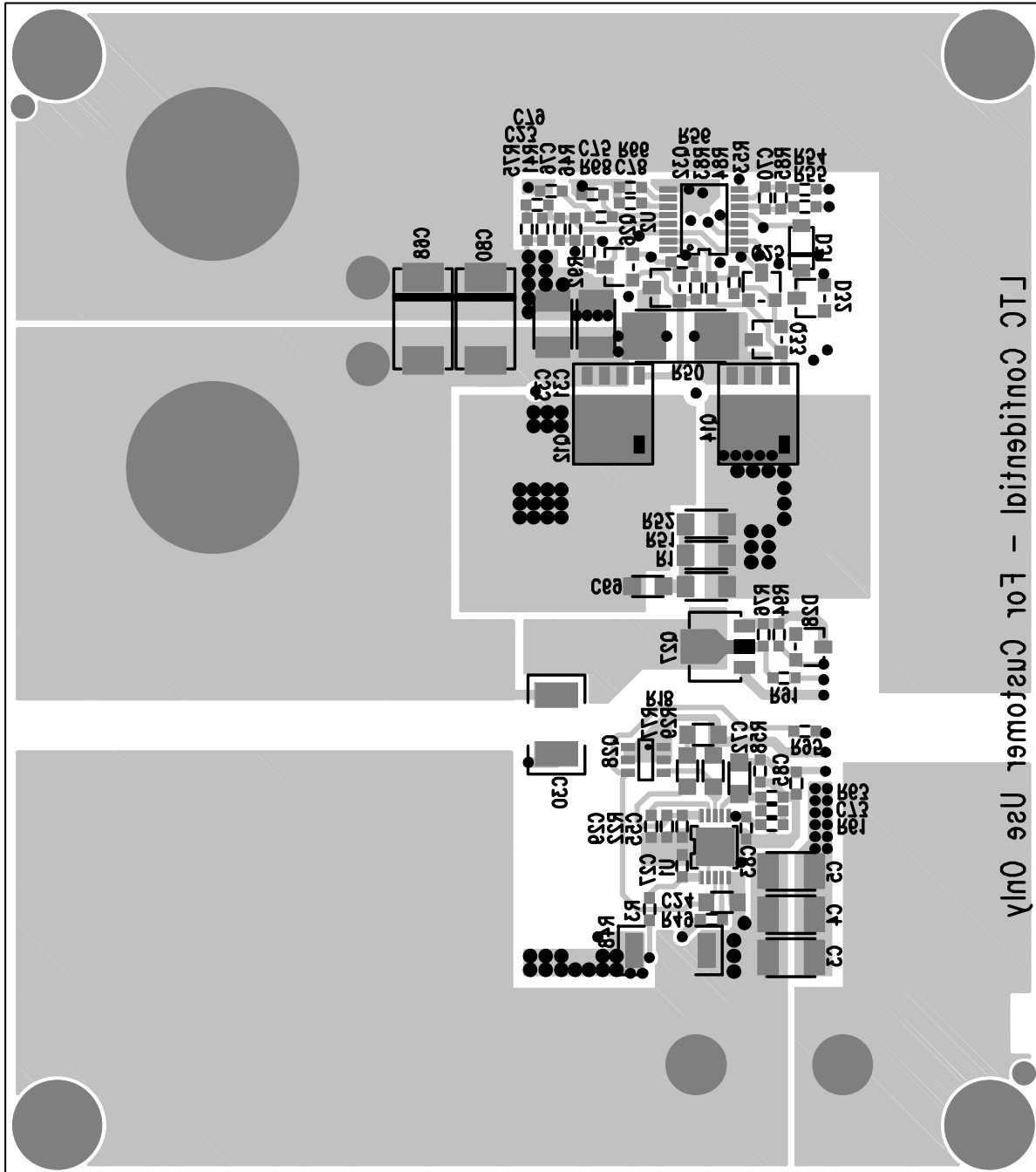
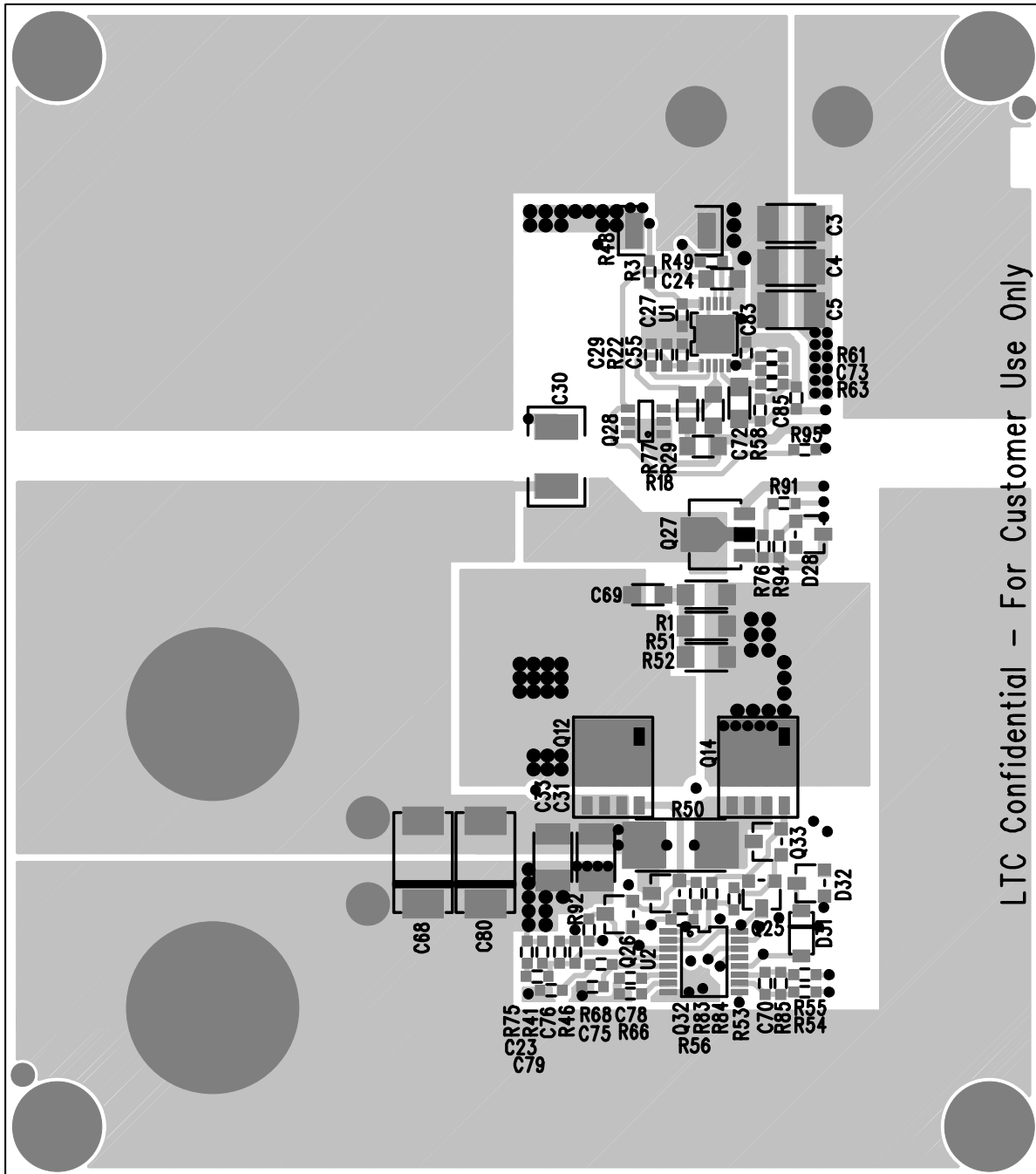

Figure 22. Bottom

# QUICK START GUIDE FOR DEMONSTRATION CIRCUIT 1032A

## 36V-72VIN, ISOLATED SYNCHRONOUS FORWARD



LTC Confidential - For Customer Use Only

Figure 23. Bottom Mirrored