

## FEATURES

- Reduces Heat, Eliminates Thermal Design Problems
- Maximizes Power Efficiency
- Less than 800 $\mu$ A Quiescent Operating Current
- Fully Compatible with IEEE 802.3 Detection and Classification
- IEEE 802.3 Compliant When Paired with a Powered Device (PD) Controller
- Works with 2-Pair and 4-Pair PoE Applications
- Compatible with PoE, PoE+, and LTPoE++™
- 100V Absolute Maximum Voltage
- H-Grade Version Operates Up to 125°C
- 16-Lead 4mm  $\times$  4mm QFN Package

## APPLICATIONS

- PoE/PoE+/ LTPoE++ Powered Devices
- DC Polarity Correction and Ideal Diode-ORing of Telecom Supplies

## DESCRIPTION

The **LT<sup>®</sup>4321** is a dual ideal diode bridge controller that enables a Power over Ethernet (PoE) powered device (PD) to receive power in either voltage polarity from RJ-45 data pairs, spare pairs, or both. The LT4321 and eight N-channel MOSFETs replace the eight diodes in a passive PoE rectifier bridge. The LT4321 eases thermal design and increases delivered power.

An internal charge pump allows an all-NMOS bridge eliminating larger and more costly PMOS switches. The LT4321 works with 2-pair and 4-pair applications. High impedance input sense pins prevent reverse current on unused pairs. If the power source fails or is shorted, a fast turn-off minimizes reverse current transients. Unlike discrete ideal bridge solutions, the LT4321 will operate through transients without enabling the MOSFETs on unpowered pairs.

LT, LT, LTC, LTM, Linear Technology and the Linear logo are registered trademarks and PowerPath and LTPoE++ are trademarks of Linear Technology Corporation. All other trademarks are the property of their respective owners.

## TYPICAL APPLICATION

Powered Device for PoE (to 13W), PoE+ (to 25.5W), or Linear LTPoE++ (to 90W) Systems

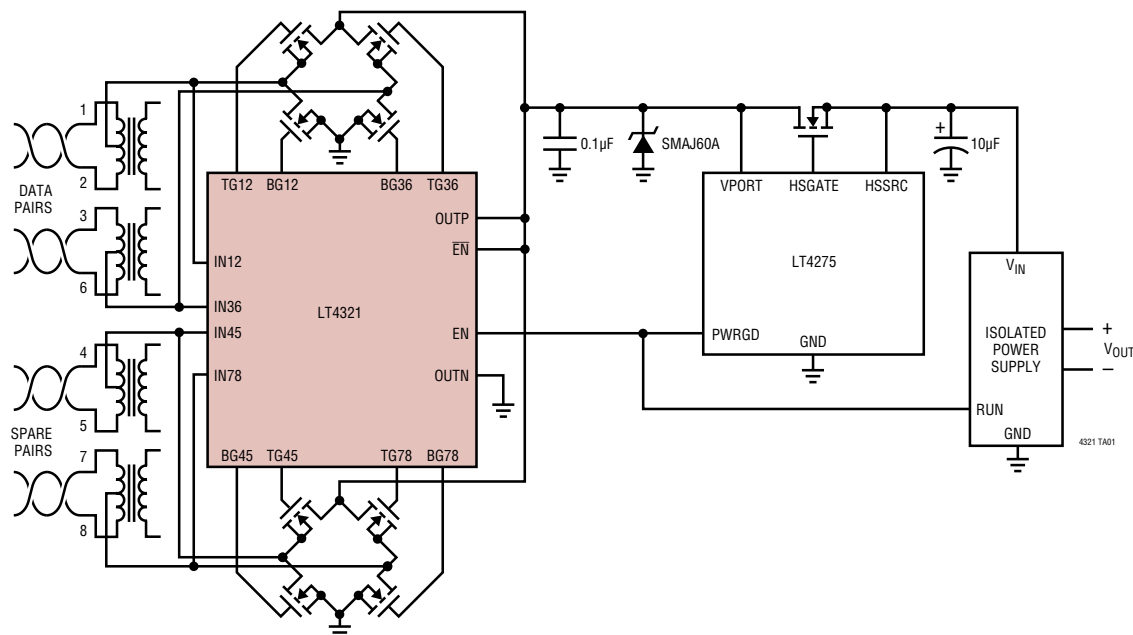

# LT4321

## ABSOLUTE MAXIMUM RATINGS

(Notes 1, 2)

|                                      |                     |
|--------------------------------------|---------------------|
| OUTP-OUTN.....                       | -0.3V to 100V       |
| IN12, IN36, IN45, IN78.....          | -2V to OUTP + 2V    |
| BG12, BG36, BG45, BG78 Voltages..... | -0.3V to 100V       |
| TG12, TG36, TG45, TG78               |                     |
| Voltages .....                       | -0.3V to OUTP + 12V |
| TG12-IN12 Voltage .....              | -0.3V to 12V        |
| TG36-IN36 Voltage .....              | -0.3V to 12V        |
| TG45-IN45 Voltage .....              | -0.3V to 12V        |
| TG78-IN78 Voltage.....               | -0.3V to 12V        |
| EN, $\overline{\text{EN}}$ ,.....    | -0.3V to 100V       |
| Operating Ambient Temperature Range  |                     |
| LT4321I.....                         | -40°C to 85°C       |
| LT4321H.....                         | -40°C to 125°C      |
| Storage Temperature Range .....      | -65°C to 150°C      |

## PIN CONFIGURATION

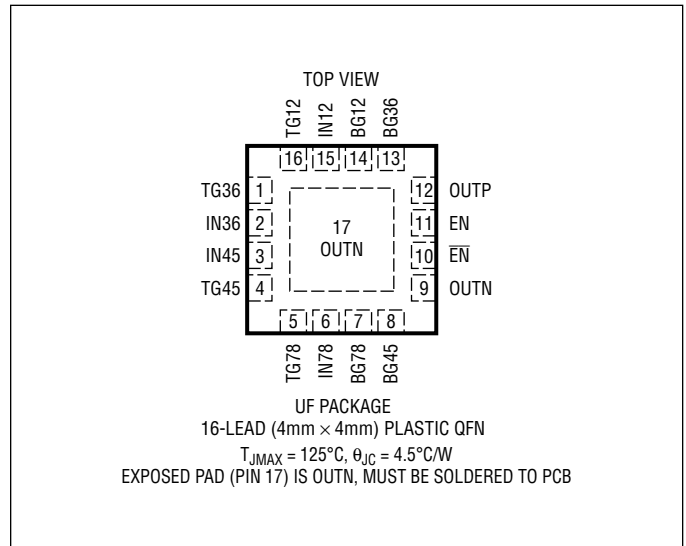

## ORDER INFORMATION

| LEAD FREE FINISH | TAPE AND REEL   | PART MARKING* | PACKAGE DESCRIPTION           | TEMPERATURE RANGE |
|------------------|-----------------|---------------|-------------------------------|-------------------|
| LT4321IUF#PBF    | LT4321IUF#TRPBF | 4321          | 16-Lead 4mm × 4mm Plastic QFN | -40°C to 85°C     |
| LT4321HUF#PBF    | LT4321HUF#TRPBF | 4321          | 16-Lead 4mm × 4mm Plastic QFN | -40°C to 125°C    |

Consult LTC Marketing for parts specified with wider operating temperature ranges. \*The temperature grade is identified by a label on the shipping container. Consult LTC Marketing for information on nonstandard lead based finish parts.

For more information on lead free part marking, go to: <http://www.linear.com/leadfree/>

For more information on tape and reel specifications, go to: <http://www.linear.com/tapeandreel/>

## ELECTRICAL CHARACTERISTICS

The ● denotes the specifications which apply over the full operating temperature range, otherwise specifications are at  $T_A = 25^\circ\text{C}$ ,  $\text{OUTP} = 20\text{V}$  to  $80\text{V}$  unless otherwise noted.

| SYMBOL                     | PARAMETER  | CONDITIONS  |   | MIN  | TYP  | MAX | UNITS            |
|----------------------------|--|---|---|------|------|-----|------------------|
|                            | Operating Supply Range                                 | IN12-IN36 ,  IN45-IN78 , OUTP   | ● | 20   |      | 80  | V                |
| $V_{\text{UVLO}}$          | Undervoltage Lockout                                   | OUTP-OUTN   | ● | 15   | 17   | 18  | V                |
| $I_{\text{S}}(\text{DET})$ | Total Supply Current in Detect Region                  | OUTP < 10V  | ● |      | 0.8  | 5   | $\mu\text{A}$    |
| $I_{\text{S}}(\text{OFF})$ | Total Supply Current in Shutdown                       | OUTP > 12V, EN < $V_{\text{IL}}$ and $\overline{\text{EN}}$ > $V_{\text{IH}}$               | ● |      | 32   | 60  | $\mu\text{A}$    |
| $I_{\text{S}}(\text{ON})$  | Total Operating Supply Current                         | EN > $V_{\text{IH}}$ or $\overline{\text{EN}}$ < $V_{\text{IL}}$ , OUTP > 20V               | ● |      | 0.5  | 0.8 | $\text{mA}$      |
|                            | Top Gate Drive   | INn = OUTP + $\Delta V_{\text{SD}(\text{MAX})}$ + 5mV, 10 $\mu\text{A}$ Out of TGn (Note 3) | ● | 7.7  | 9.5  | 11  | V                |
| $V_{\text{BG}}$            | Bottom Gate Drive                                      | 10 $\mu\text{A}$ Out of BGn (Note 3)  | ● | 10   | 11.5 | 13  | V                |
|                            | Top Gate Pull-Up Current                               | TGn = INn (Note 3)  | ● | 50   | 120  | 250 | $\mu\text{A}$    |
|                            | Top Gate Pull-Down Current                             | INn = OUTP - 0.25V; TGn - INn = 5V  | ● | 1.25 |      |     | $\text{mA}$      |
|                            | Bottom Gate Pull-Up Current                            | BGn < $V_{\text{BG}}$ (Note 3)  | ● | 15   | 30   | 45  | $\mu\text{A}$    |
|                            | Bottom Gate Pull-Down Current                          | BGn = 5V  | ● | 3    |      |     | $\text{mA}$      |
|                            | $\overline{\text{EN}}$ Pull-Up Resistance (Active Low) | OUTP = 55V  | ● | 160  | 250  | 310 | $\text{k}\Omega$ |
|                            | EN Pull-Down Resistance (Active High)                  | OUTP = 55V  | ● | 160  | 250  | 310 | $\text{k}\Omega$ |
| $V_{\text{IH}}$            | Digital Input High                                     | EN, $\overline{\text{EN}}$  | ● |      |      | 2.6 | V                |
| $V_{\text{IL}}$            | Digital Input Low                                      | EN, $\overline{\text{EN}}$  | ● | 0.5  |      |     | V                |
| $V_{\text{ENOC}}$          | $\overline{\text{EN}}$ Open Circuit Voltage            | OUTP = 55V  | ● | 2    | 2.5  | 3   | V                |
| $\Delta V_{\text{SD}}$     | Topside Forward Regulation Voltage                     | INn - OUTP  | ● | 2    | 10   | 18  | mV               |
|                            | Bottom Comparator Turn-On Threshold                    | INn - OUTN  | ● | -30  | -15  | 0   | mV               |
|                            | Bottom Comparator Turn-Off Threshold                   | INn - OUTN  | ● | 2    | 15   | 30  | mV               |

**Note 1:** Stresses beyond those listed under Absolute Maximum Ratings may cause permanent damage to the device. Exposure to any Absolute Maximum Rating condition for extended periods may affect device reliability and lifetime.

**Note 2:** Referenced with respect to OUTN unless otherwise specified.

**Note 3:** All conditions for external MOSFET turn on must be met. See Table 1 and Table 2.

TYPICAL PERFORMANCE CHARACTERISTICS

Total Supply Current in Shutdown

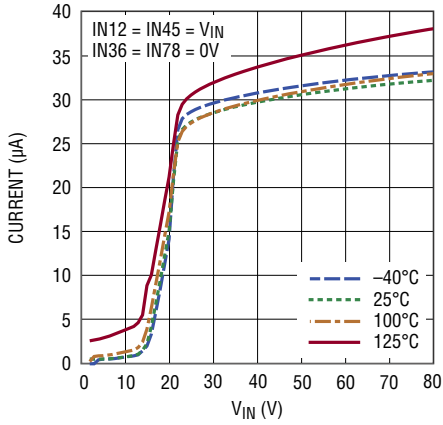

Total Supply Current in Ideal Bridge Mode, 2-Pair

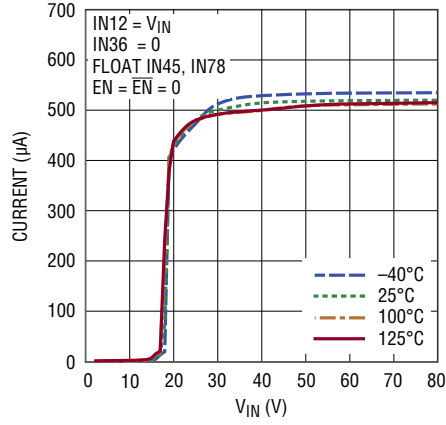

Total Supply Current in Ideal Bridge Mode, 4-Pair

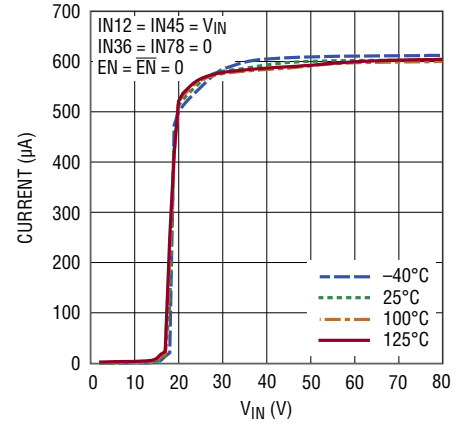

Input Pin Current

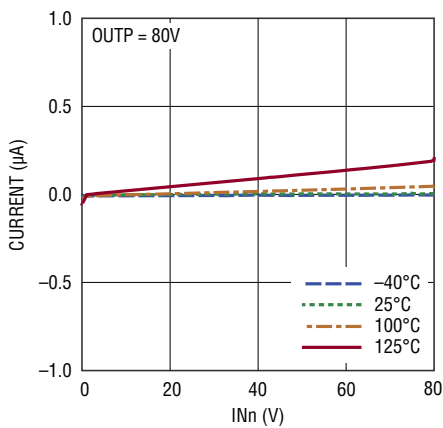

EN Open Circuit Voltage

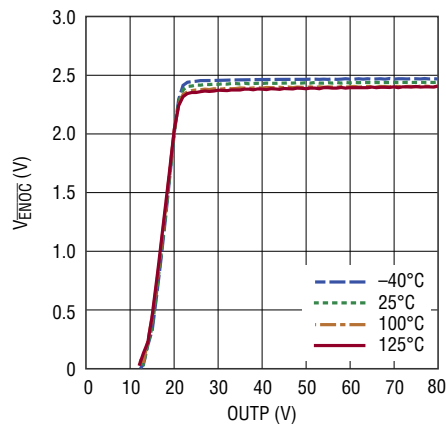

BGn Pull-Down Strength

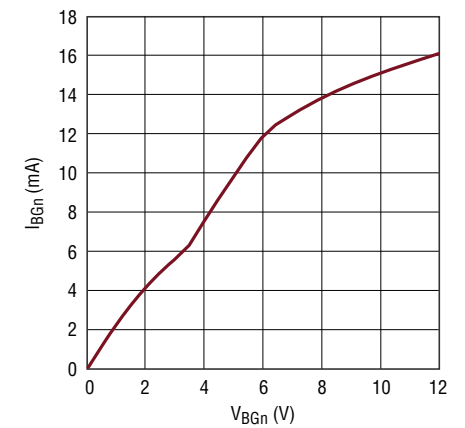

BGn Pull-Up Strength

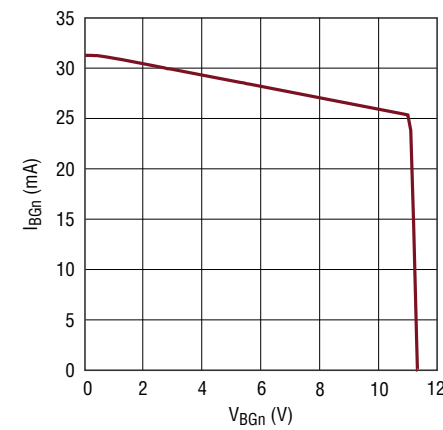

TG Pull-Down Strength

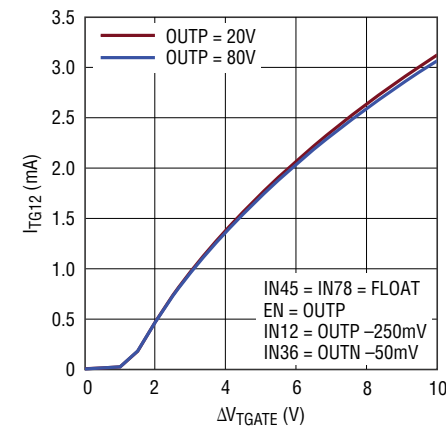

TG Pull-Up Strength

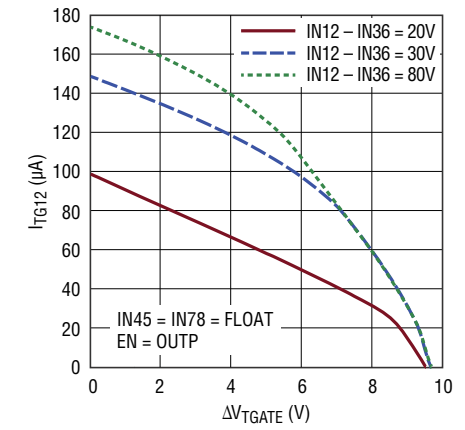

## PIN FUNCTIONS

**IN12:** Data Pair Input 1. In a PoE system, IN12 connects to the center tap of the transformer connected to pins 1 and 2 on an RJ45 connector.

**IN36:** Data Pair Input 2. In a PoE system, IN36 connects to the center tap of the transformer connected to pins 3 and 6 on an RJ45 connector.

**IN45:** Spare Pair Input 1. In a PoE system, IN45 connects to the center tap of the transformer connected to pins 4 and 5 on an RJ45 connector.

**IN78:** Spare Pair Input 2. In a PoE system, IN78 connects to the center tap of the transformer connected to pins 7 and 8 on an RJ45 connector.

**TG12:** Top-Side Gate Driver Output. TG12 pin pulls high with respect to IN12 when IN12 is greater than OUTP and IN36 is less than OUTN.

**TG36:** Top-Side Gate Driver Output. TG36 pin pulls high with respect to IN36 when IN36 is greater than OUTP and IN12 is less than OUTN.

**TG45:** Top-Side Gate Driver Output. TG45 pin pulls high with respect to IN45 when IN45 is greater than OUTP and IN78 is less than OUTN.

**TG78:** Top-Side Gate Driver Output. TG78 pin pulls high with respect to IN78 when IN78 is greater than OUTP and IN45 is less than OUTN.

**BG12:** Bottom-Side Gate Driver Output. BG12 pin pulls high with respect to OUTN when IN36 is greater than OUTP and IN12 is less than OUTN.

**BG36:** Bottom-Side Gate Driver Output. BG36 pin pulls high with respect to OUTN when IN12 is greater than OUTP and IN36 is less than OUTN.

**BG45:** Bottom-Side Gate Driver Output. BG45 pin pulls high with respect to OUTN when IN78 is greater than OUTP and IN45 is less than OUTN.

**BG78:** Bottom-Side Gate Driver Output. BG78 pin pulls high with respect to OUTN when IN45 is greater than OUTP and IN78 is less than OUTN.

**$\overline{\text{EN}}$ :** Enable, Active Low. Pull down to OUTN to enable ideal diode bridge mode. EN is internally pulled up to  $V_{\text{ENOC}}$ . Tie to OUTP if the application circuit uses the EN pin to enable ideal bridge mode.

**EN:** Enable, Active High. Pull up to enable ideal diode bridge mode. EN is internally pulled down to OUTN. Tie to OUTN if the application circuit uses the  $\overline{\text{EN}}$  pin to enable ideal bridge mode.

**OUTP:** Positive Output Voltage. OUTP is the rectified voltage from which the LT4321 draws power.

**OUTN:** Negative Output Voltage. OUTN is the negative rectified voltage.

**EXPOSED PAD:** The exposed pad must be electrically connected to the OUTN pin.

## APPLICATIONS INFORMATION

### OVERVIEW

The LT4321 is a dual ideal diode bridge controller designed to rectify two independent DC channels into a single output. The LT4321 senses the greater of the two input channels,  $|IN12-IN36|$  or  $|IN45-IN78|$ , and connects them to the output with the correct polarity. Smooth crossover between channels is guaranteed by the enforced dropout voltage,  $\Delta V_{SD}$ .

A very common application is an IEEE 802.3 powered device which is required to accept voltage in either polarity at its RJ-45 input. Polarity correction devices allow the PD to work equally well with standard or cross-over cables and endspan or midspan PSEs. They also prevent the PD from back feeding current into the Ethernet cable.

PD polarity correction is commonly done with a traditional diode bridge, but this results in an efficiency loss due to the forward drop generated across two conducting diodes. This voltage drop reduces the available supply voltage and dissipates significant power.

The LT4321 uses actively driven MOSFETs to nearly eliminate the forward voltage drop. By maximizing available voltage and reducing power dissipation (Figure 1), the LT4321 simplifies PD design and reduces power supply cost. It can also eliminate thermal design problems, costly heat sinks, and reduce PC board area.

Some designs use ideal diode bridge circuits implemented with discrete components. These bridges often suffer from a trade-off between quiescent current and tolerance to transients and leakage. With quiescent current properly tuned for PoE, stray PCB leakage between bridge components can be enough to cause accidental turn-on, latchup, and destruction of the circuit.

The LT4321 offers significant improvements over discrete solutions. The integrated bridge controller allows for sophisticated sensing and control of the PowerPath™ MOSFETs, ensuring that MOSFETs that are supposed to be off, stay off. An ideal bridge controlled by the LT4321 is tolerant to hot-plugs, input short-circuits, common mode shift, and PCB leakage in the application circuit.

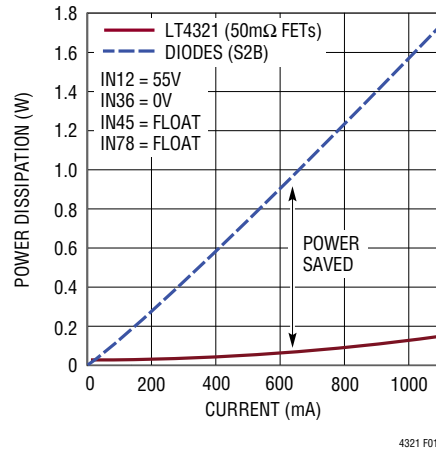

Figure 1. Power Dissipation vs Load Current

### OPERATING MODES

#### Ideal Diode Bridge Mode

In ideal bridge mode the LT4321 saves power by activating MOSFETs in place of power path diodes. The LT4321 enters ideal bridge mode when  $OUTP$  is greater than  $V_{UVLO}$  and either  $EN$  or  $\overline{EN}$  is asserted.

When the LT4321 is enabled, it senses the inputs with respect to the output to decide which external MOSFETs to turn on. Inputs are grouped into pairs,  $IN12/IN36$  and  $IN45/IN78$ . Within each pair, one input voltage must be greater than  $OUTP$  and one must be less than  $OUTN$  before the external MOSFETs related to that pair are enabled. For example, if  $IN36$  is greater than  $OUTP$  and  $IN12$  is less than  $OUTN$ ,  $TG36$  and  $BG12$  will turn on. Table 1 and Table 2 outline the conditions that activate the ideal diode bridge.

#### Shutdown Mode

Shutdown mode is intended to keep the LT4321 quiescent current from interfering with detection and classification in a PoE system (Figure 2). The LT4321 is always in shutdown mode when  $OUTP < V_{UVLO}$ . It can be held in shutdown mode over the full operating voltage range by deasserting both the  $EN$  and  $\overline{EN}$  pins.

## APPLICATIONS INFORMATION

**Table 1. Conditions for Ideal Bridge Mode on IN12/IN36**

| PoE MODE                      | OUTP                | EN   EN | IN12   | IN36   | IN45 | IN78 | TG12 | TG36 | BG12 | BG36 |
|-------------------------------|---------------------|---------|--------|--------|------|------|------|------|------|------|
| Detect/Class                  | < V <sub>UVLO</sub> | X       | X      | X      | X    | X    | OFF  |      |      |      |
| Class/Inrush                  |                     | 0       |        |        |      |      |      |      |      |      |
| Power ON                      | > V <sub>UVLO</sub> | 1       | > OUTP | < OUTN | X    | X    | ON   | OFF  | OFF  | ON   |
|                               |                     |         | < OUTN | > OUTP |      |      | OFF  | ON   | ON   | OFF  |
| IN12 – IN36  <<br>OUTP – OUTN |                     |         | > OUTN |        |      |      | OFF  |      |      |      |
|                               |                     |         | < OUTP |        |      |      |      |      |      |      |

**Table 2. Conditions for Ideal Bridge Mode on IN45/IN78**

| PoE MODE                      | OUTP                | EN   EN | IN12 | IN36 | IN45   | IN78   | TG45 | TG78 | BG45 | BG78 |
|-------------------------------|---------------------|---------|------|------|--------|--------|------|------|------|------|
| Detect/Class                  | < V <sub>UVLO</sub> | X       | X    | X    | X      | X      | OFF  |      |      |      |
| Class/Inrush                  |                     | 0       |      |      |        |        |      |      |      |      |
| Power ON                      | > V <sub>UVLO</sub> | 1       | X    | X    | > OUTP | < OUTN | ON   | OFF  | OFF  | ON   |
|                               |                     |         |      |      | < OUTN | > OUTP | OFF  | ON   | ON   | OFF  |
| IN45 – IN78  <<br>OUTP – OUTN |                     |         |      |      | > OUTN |        | OFF  |      |      |      |
|                               |                     |         |      |      | < OUTP |        |      |      |      |      |

Shutting down the LT4321 does not disconnect the load. The external MOSFETs are shorted gate to source and bridge current is carried by the MOSFETs’ body diodes. The eight body diodes will act like two traditional diode bridges.

At light load, the power dissipated in the forward drop of the body diodes will be less than the power dissipated by the LT4321 quiescent current. In applications with a low power sleep mode, the LT4321 can optionally be shut down to save power if the load current is less than 20mA.

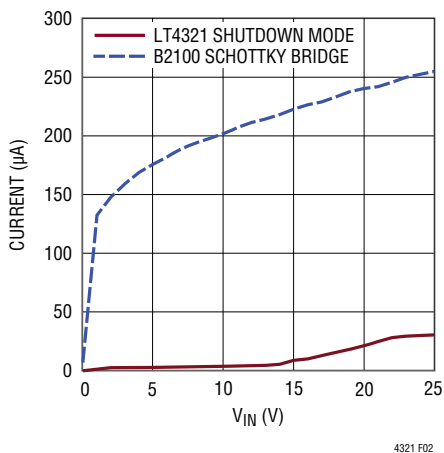

**Figure 2. Leakage Current at 125°C**

## EXTERNAL INTERFACE AND COMPONENT SELECTION

### Bypass Capacitance

A 0.1µF ceramic capacitor must be placed across the OUTP and OUTN pins.

In PD applications, the IEEE 802.3 standard limits the port capacitance at the PD interface (C<sub>PD</sub>) to 0.12µF. The LT4321 and the PD interface controller both need local bypass capacitance, but they can share the same 0.1µF capacitor. If the LT4321 and the PD interface controller cannot both be positioned next to a shared bypass capacitor, split the C<sub>PD</sub> capacitance between the two chips by placing a 0.047µF ceramic close to the LT4321 and another 0.047µF ceramic close to the PD interface controller.

A 10µF or greater capacitance must be connected across OUTP and OUTN pins when the LT4321 is enabled. In PoE applications it is sufficient for the C<sub>PORT</sub> capacitor to be connected by the PD interface controller’s hot swap FET. In non PoE applications the C<sub>PORT</sub> capacitor may be permanently connected between OUTP and OUTN.

## APPLICATIONS INFORMATION

### Transient Voltage Suppressor

The LT4321 specifies an absolute maximum voltage of 100V and is designed to tolerate brief overvoltage events. However, pins that interface to Ethernet cables or remote telecom supplies can routinely see excessive peak voltages. To protect the LT4321, install a unidirectional transient voltage suppressor (TVS) such as an SMAJ60A between OOTP and OUTN. This TVS must be mounted as close as possible to the LT4321.

For extremely high cable discharge and surge protection contact Linear Technology Applications.

### MOSFET Selection

Select external MOSFETs that have a drain-source breakdown voltage higher than the maximum input voltage. For PoE systems the drain-source breakdown should be at least 100V. For all applications the gate threshold must be a minimum of 2V.

The amount of power saved by the LT4321 depends on the channel resistance,  $R_{DS(ON)}$ , of the external MOSFETs. To maximize performance and power savings select  $R_{DS(ON)}$  such that the forward voltage drop,  $V_F$ , is between 20mV and 70mV. Given the average output load current,  $I_{AVG}$ :

$$R_{DS(ON)} = V_F / I_{AVG}$$

For example, a PoE+ class 4 PD's maximum average current,  $I_{AVG}$ , is 600mA. Choosing a MOSFET forward voltage drop of 40mV reduces power consumption to 1/15th that of a B2100 Schottky diode bridge.

$$R_{DS(ON)} = 40\text{mV} / 600\text{mA} = 66\text{m}\Omega$$

### Enable Pins

When OOTP is greater than  $V_{UVLO}$ , the enable pins EN and  $\overline{EN}$  will control whether the LT4321 is in shutdown mode or ideal bridge mode (Table 1 and Table 2). EN and  $\overline{EN}$  may be driven by a 3.3V or 5V logic signal, or with an open drain or collector.

The  $\overline{EN}$  pin is pulled up to the internally generated voltage  $V_{\overline{ENOC}}$  by an internal 250k $\Omega$  resistor. The EN pin is pulled down to OUTN by an internal 250k $\Omega$  resistor. When OOTP is less than 12V the enable pins are high impedance to prevent these resistors from corrupting PoE detection.

The enable pins tolerate 100V (absolute maximum) and may be tied directly to the OOTP or OUTN pins as needed.

Figure 3 and Figure 4 show how to interface the enable pins to a PD interface controller. In these configurations, the LT4321 PoE ideal bridge will be enabled after detection and classification are complete and before the PD is consuming a significant amount of current.







# PACKAGE DESCRIPTION

Please refer to <http://www.linear.com/designtools/packaging/> for the most recent package drawings.

## UF Package 16-Lead Plastic QFN (4mm × 4mm) (Reference LTC DWG # 05-08-1692 Rev 0)

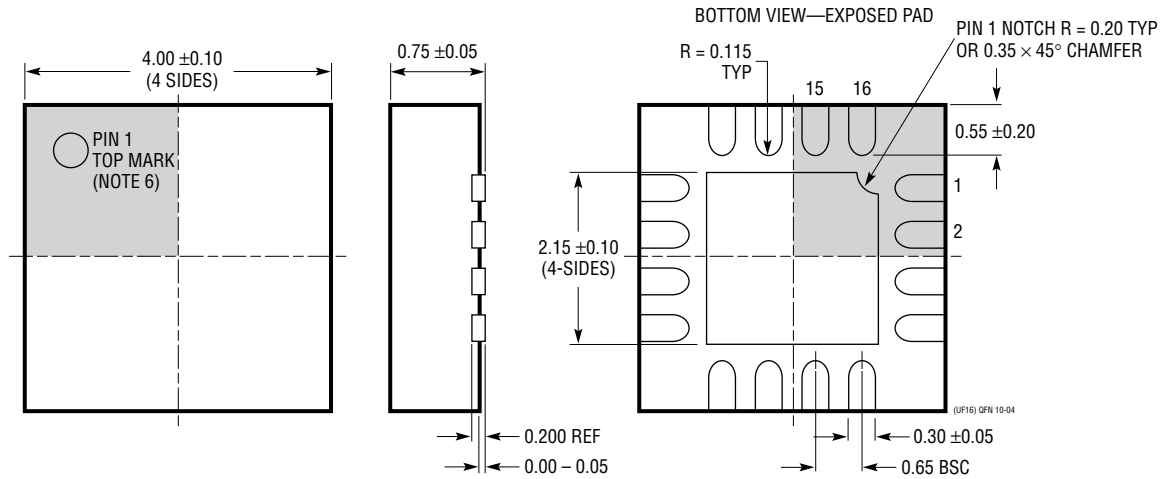
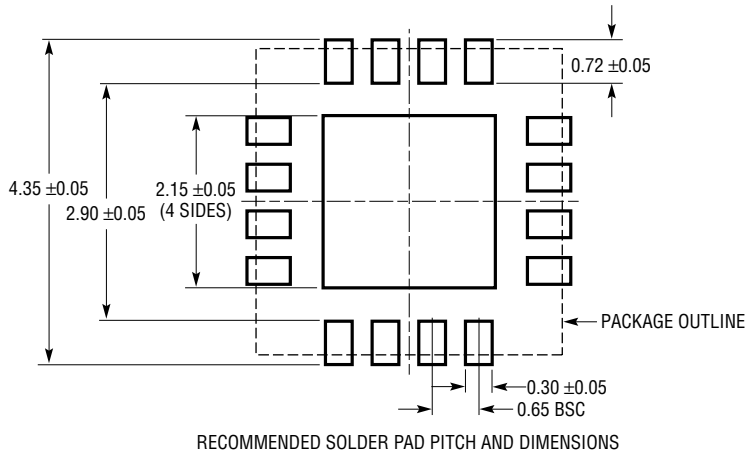

# LT4321

## TYPICAL APPLICATION

### LTPoE++ 70W Powered Device

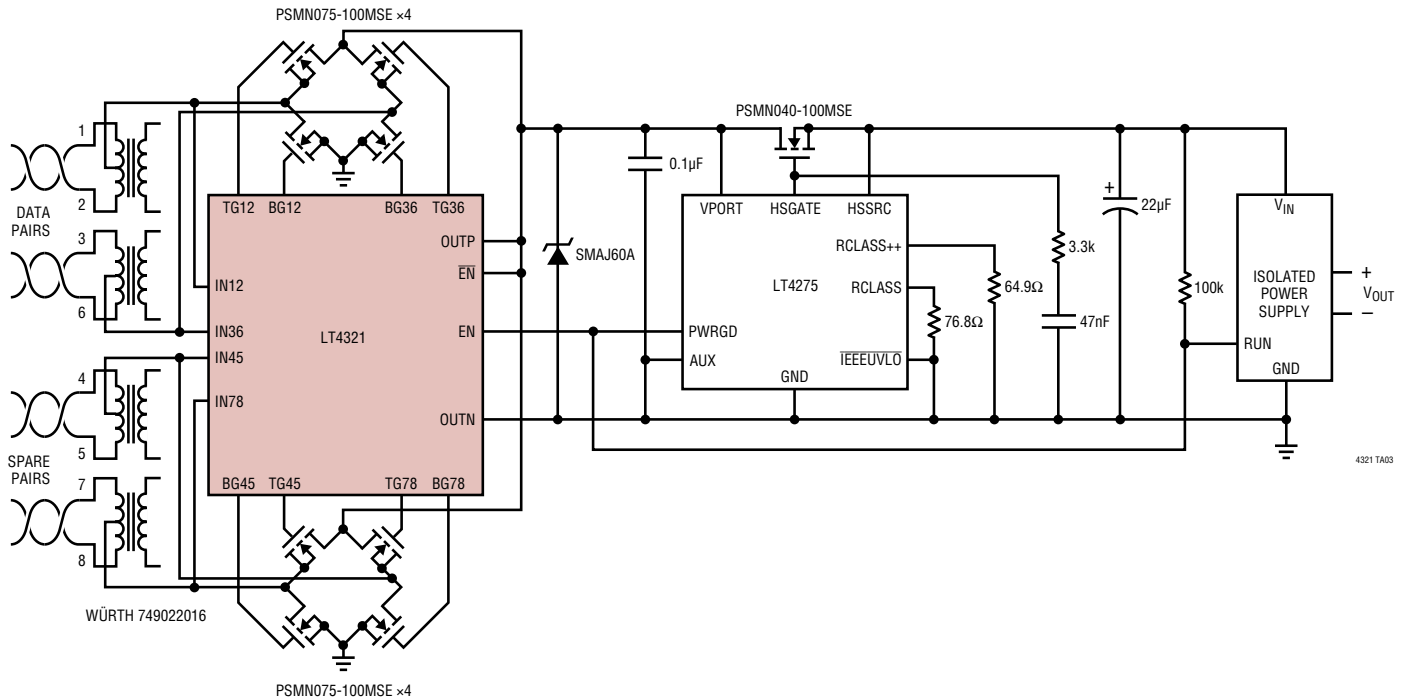

## RELATED PARTS

| PART NUMBER                               | DESCRIPTION   | COMMENTS   |
|---|---|--|
| <a href="#">LTC4265</a>                   | IEEE 802.3at PD Interface Controller                                  | Internal 100V, 1A Switch, 2-Event Classification Recognition   |
| <a href="#">LTC4266/LTC4266A/LTC4266C</a> | Quad PoE PSE Controller   | IEEE 802.3at, LTPoE++, IEEE 802.3af Power Levels   |
| <a href="#">LTC4269-1/LTC4269-2</a>       | IEEE 802.3af PD Interface with Switching Regulator                    | LTC4269-1 for Flyback, LTC4269-2 for Forward Regulator   |
| <a href="#">LTC4270/LTC4271</a>           | 12-Port PoE/PoE+/LTPoE++ PSE Controller                               | Transformer Isolation, Supports IEEE 802.3af, IEEE 802.3at and LTPoE++ PDs   |
| <a href="#">LTC4274/LTC4274A/LTC4274C</a> | Single PoE PSE Controller   | IEEE 802.3at, LTPoE++ 90W, IEEE 802.3af Power Levels   |
| <a href="#">LT4275A/LT4275B/LT4275C</a>   | LTPoE++/PoE+/PoE PD Controller  | External Switch, LTPoE++ Support   |
| <a href="#">LTC4278</a>                   | IEEE 802.3af PD Interface with Integrated Flyback Switching Regulator | 2-Event Classification, Programmable Class, Synchronous No-Opto Flyback Controller, 50kHz to 250kHz, 12V Aux Support |
| <a href="#">LTC4290/LTC4271</a>           | 8-Port PoE/PoE+/LTPoE++ PSE Controller                                | Transformer Isolation, Supports IEEE 802.3af, IEEE 802.3at and LTPoE++ PDs   |
| <a href="#">LT4320</a>                    | Ideal Diode Bridge Controller   | 9V to 72V, DC to 600Hz, N-Channel Ideal Diode Bridge   |
| <a href="#">LTC4354</a>                   | Negative Voltage Diode-OR Controller and Monitor                      | Controls Two N-Channel MOSFETs, 1.2µs Turn-Off, -80V Operation   |
| <a href="#">LTC4355</a>                   | Positive Voltage Diode-OR Controller and Monitor                      | Controls Two N-Channel MOSFETs, 0.4µs Turn-Off, 9V to 80V Operation  |
| <a href="#">LTC4359</a>                   | Ideal Diode Controller with Reverse Input Protection                  | N-Channel, 4V to 80V, MSOP-8 and DFN-6 Packages  |

4321f