

Trimmer Potentiometers



SMD Sealed Type 3mm Size PVG3 Series

■ Features

1. Sealed construction protects the interior from dust and liquid, which achieves stable performance.
2. Driver plate with cross-slot is suitable for automatic adjustment.
3. Rotor with large diameter and deep groove improves driver insertion.
4. J-hook, Gull wing terminal shape. Rear and through hole terminal shape.
5. 3mm and 4mm land pattern can be used without change. (Gull wing is suitable for 4mm size land pattern.)
6. Heat resistance performance enables high temperature peak re-flow soldering.
7. To be complied with RoHS directive by new Cd free cermet resistive material. Pb free terminals with Sn plating.

■ Applications

1. Small sensors
2. Optical Transceiver Module
3. Copier
4. Printer
5. Compact Power Supply
6. Wireless Radio module



PVG3A

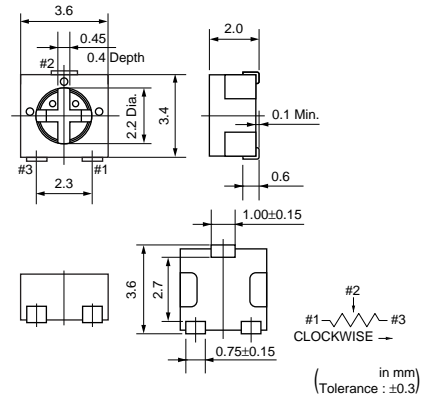

PVG3G

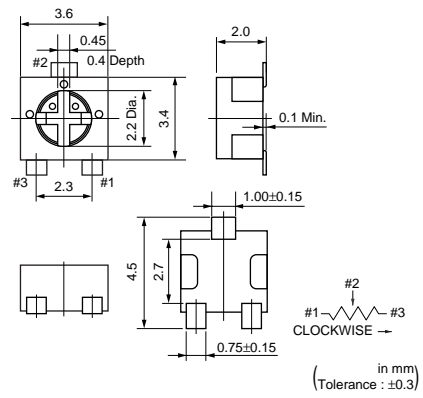

PVG3K

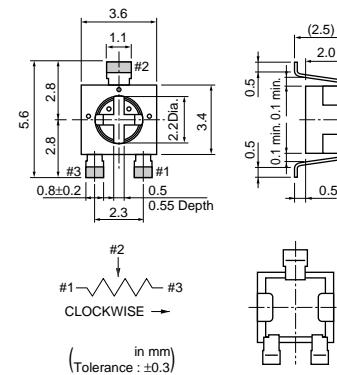

4

Part Number	Power Rating	Soldering Method	Number of Turns (Effective Rotation Angle)	Total Resistance Value	TCR
PVG3□100C01	0.25W(70°C)	Reflow/Soldering Iron	1(210°±10°)	10ohm ±20%	±150ppm/°C
PVG3□200C01	0.25W(70°C)	Reflow/Soldering Iron	1(210°±10)	20ohm ±20%	±150ppm/°C
PVG3□500C01	0.25W(70°C)	Reflow/Soldering Iron	1(210°±10°)	50ohm ±20%	±150ppm/°C
PVG3□101C01	0.25W(70°C)	Reflow/Soldering Iron	1(210°±10°)	100ohm ±20%	±150ppm/°C
PVG3□201C01	0.25W(70°C)	Reflow/Soldering Iron	1(210°±10°)	200ohm ±20%	±150ppm/°C
PVG3□501C01	0.25W(70°C)	Reflow/Soldering Iron	1(210°±10°)	500ohm ±20%	±150ppm/°C
PVG3□102C01	0.25W(70°C)	Reflow/Soldering Iron	1(210°±10°)	1k ohm ±20%	±150ppm/°C
PVG3□202C01	0.25W(70°C)	Reflow/Soldering Iron	1(210°±10°)	2k ohm ±20%	±150ppm/°C
PVG3□502C01	0.25W(70°C)	Reflow/Soldering Iron	1(210°±10°)	5k ohm ±20%	±150ppm/°C
PVG3□103C01	0.25W(70°C)	Reflow/Soldering Iron	1(210°±10°)	10k ohm ±20%	±150ppm/°C
PVG3□203C01	0.25W(70°C)	Reflow/Soldering Iron	1(210°±10°)	20k ohm ±20%	±150ppm/°C
PVG3□503C01	0.25W(70°C)	Reflow/Soldering Iron	1(210°±10°)	50k ohm ±20%	±150ppm/°C

Continued on the following page.



⚠Note Please read rating and ⚠CAUTION (for storage, operating, rating, soldering, mounting and handling) in this PDF catalog to prevent smoking and/or burning, etc.
This catalog has only typical specifications. Therefore, you are requested to approve our product specifications or to transact the approval sheet for product specifications before ordering.

Continued from the preceding page.

Part Number	Power Rating	Soldering Method	Number of Turns (Effective Rotation Angle)	Total Resistance Value	TCR
PVG3□104C01	0.25W(70°C)	Reflow/Soldering Iron	1(210°±10°)	100k ohm ±20%	±150ppm/°C
PVG3□204C01	0.25W(70°C)	Reflow/Soldering Iron	1(210°±10°)	200k ohm ±20%	±150ppm/°C
PVG3□504C01	0.25W(70°C)	Reflow/Soldering Iron	1(210°±10°)	500k ohm ±20%	±150ppm/°C
PVG3□105C01	0.25W(70°C)	Reflow/Soldering Iron	1(210°±10°)	1M ohm ±20%	±150ppm/°C
PVG3□205C01	0.25W(70°C)	Reflow/Soldering Iron	1(210°±10°)	2M ohm ±20%	±150ppm/°C

The blank column is filled with the code of adjustment direction and lead type A (top, J-hook), G (top, gull-wing), or K (rear).

Part Number	Power Rating (W)	Soldering Method	Number of Turns (Effective Rotation Angle)	Total Resistance Value	TCR (ppm/°C)	Remarks
PVG3□100A01	0.25(70°C)	Reflow/Soldering Iron	1(210°±10°)	10 ohm±20%	±250	Non Standard Product (Cd included)
PVG3□200A01	0.25(70°C)	Reflow/Soldering Iron	1(210°±10°)	20 ohm±20%	±250	
PVG3□500A01	0.25(70°C)	Reflow/Soldering Iron	1(210°±10°)	50 ohm±20%	±250	
PVG3□101A01	0.25(70°C)	Reflow/Soldering Iron	1(210°±10°)	100 ohm±20%	±250	
PVG3□201A01	0.25(70°C)	Reflow/Soldering Iron	1(210°±10°)	200 ohm±20%	±100	
PVG3□501A01	0.25(70°C)	Reflow/Soldering Iron	1(210°±10°)	500 ohm±20%	±100	
PVG3□102A01	0.25(70°C)	Reflow/Soldering Iron	1(210°±10°)	1k ohm±20%	±100	
PVG3□202A01	0.25(70°C)	Reflow/Soldering Iron	1(210°±10°)	2k ohm±20%	±100	
PVG3□502A01	0.25(70°C)	Reflow/Soldering Iron	1(210°±10°)	5k ohm±20%	±100	
PVG3□103A01	0.25(70°C)	Reflow/Soldering Iron	1(210°±10°)	10k ohm±20%	±100	
PVG3□203A01	0.25(70°C)	Reflow/Soldering Iron	1(210°±10°)	20k ohm±20%	±100	
PVG3□503A01	0.25(70°C)	Reflow/Soldering Iron	1(210°±10°)	50k ohm±20%	±100	
PVG3□104A01	0.25(70°C)	Reflow/Soldering Iron	1(210°±10°)	100k ohm±20%	±100	
PVG3□204A01	0.25(70°C)	Reflow/Soldering Iron	1(210°±10°)	200k ohm±20%	±100	
PVG3□504A01	0.25(70°C)	Reflow/Soldering Iron	1(210°±10°)	500k ohm±20%	±100	
PVG3□105A01	0.25(70°C)	Reflow/Soldering Iron	1(210°±10°)	1M ohm±20%	±100	
PVG3□205A01	0.25(70°C)	Reflow/Soldering Iron	1(210°±10°)	2M ohm±20%	±100	

4

■ Construction

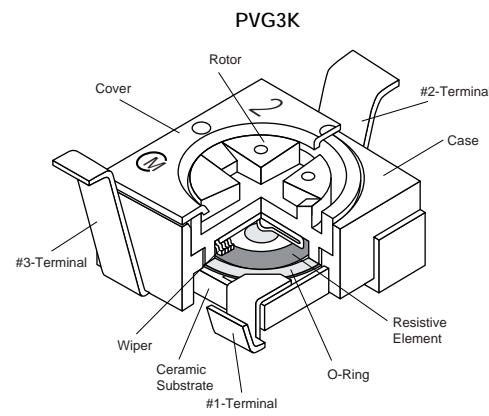
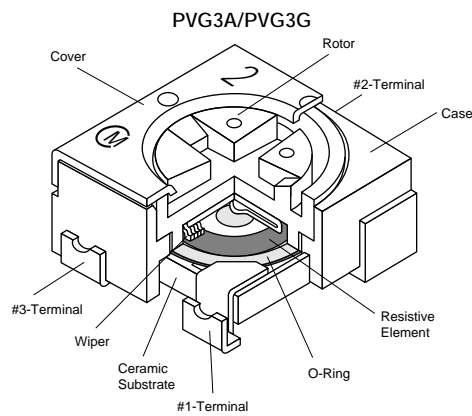

■ Standard Land Pattern

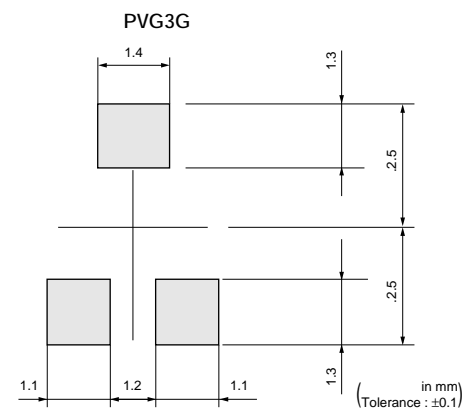
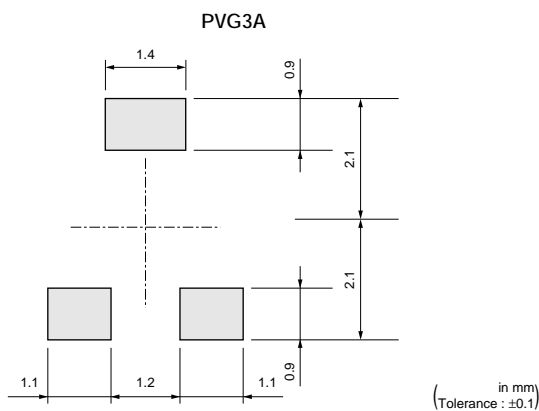

Continued on the following page. ↗

△Note Please read rating and △CAUTION (for storage, operating, rating, soldering, mounting and handling) in this PDF catalog to prevent smoking and/or burning, etc.
 This catalog has only typical specifications. Therefore, you are requested to approve our product specifications or to transact the approval sheet for product specifications before ordering.

Continued from the preceding page.

■ Standard Land Pattern

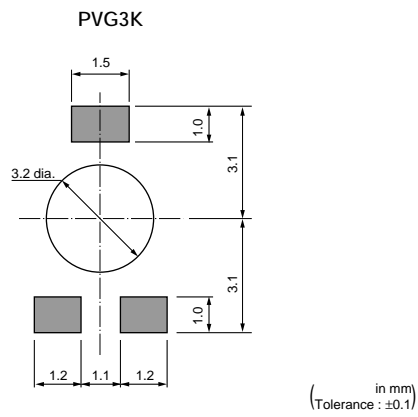

■ Characteristics

Temperature Cycle	ΔTR $\pm 2\%$ $\Delta V.S.S$ $\pm 1\%$
Humidity	ΔTR $\pm 2\%$ $\Delta V.S.S$ $\pm 1\%$ IR 10Mohm min.
Vibration (20G)	ΔTR $\pm 1\%$ $\Delta V.S.S$ $\pm 1\%$
Shock (100G)	ΔTR $\pm 1\%$ $\Delta V.S.S$ $\pm 1\%$
Temperature Load Life	ΔTR $\pm 3\%$ or 3ohm max., whichever is greater $\Delta V.S.S$ $\pm 1\%$
Low Temperature Exposure	ΔTR $\pm 2\%$ $\Delta V.S.S$ $\pm 2\%$
High Temperature Exposure	ΔTR $\pm 3\%$ $\Delta V.S.S$ $\pm 2\%$
Rotational Life (50cycles)	ΔTR $R \leq 100\text{ohm} \dots \pm 3\%$ or 2ohm max., whichever is greater $R > 100\text{kohm} \dots +0/-10\%$

ΔTR : Total Resistance Change
 $\Delta V.S.S$: Voltage Setting Stability
 IR : Insulation Resistance
 R : Standard Total Resistance

PVG3 Series Notice

■ Notice (Operating and Storage Conditions)

1. Store in temperatures of -10 to +40 deg. C and relative humidity of 30-85%RH.
2. Do not store in or near corrosive gases.
3. Use within six months after delivery.
4. Open the package just before using.
5. Do not store under direct sunlight.
6. If you use the trimmer potentiometer in an environment other than listed below, please consult with a Murata factory representative prior to using.
The trimmer potentiometer should not be used under

the following environmental conditions:

- (1) Corrosive gaseous atmosphere
(Ex. Chlorine gas, Hydrogen sulfide gas, Ammonia gas, Sulfuric acid gas, Nitric oxide gas, etc.)
- (2) In liquid
(Ex. Oil, Medical liquid, Organic solvent, etc.)
- (3) Dusty / dirty atmosphere
- (4) Direct sunlight
- (5) Static voltage nor electric/magnetic fields
- (6) Direct sea breeze
- (7) Other variations of the above

4

■ Notice (Rating)

1. When using with partial load (rheostat), minimize the power depending on the resistance value.
2. The maximum input voltage to a trimmer potentiometer should not exceed $(P \cdot R)^{1/2}$ or the maximum operating voltage, whichever is smaller.
3. The maximum input current to a trimmer potentiometer should not exceed $(P/R)^{1/2}$ or the allowable wiper current, whichever is smaller.

■ Notice (Soldering and Mounting)

1. Soldering

- (1) Standard soldering condition
 - (a) Reflow soldering :
Refer to the standard temperature profile.
 - (b) Soldering iron
Temperature of tip : 400 deg. C max.
Soldering time : 3 sec. max.
Diameter of tip : 2mm dia. max.
Wattage of iron : 30W max.

Before using other soldering conditions more than those listed above, please consult with a Murata factory representative prior to using.
If the soldering conditions are not suitable, e.g., excessive time and/or excessive temperature, the trimmer potentiometer may deviate from the specified characteristics.

- (2) Cannot be soldered using the flow soldering method. If you use the flow soldering method, the trimmer potentiometer may not function.
- (3) The soldering iron should not come in contact with the case of the trimmer potentiometer. If such contact does occur, the trimmer potentiometer may be damaged.
- (4) Apply the appropriate amount of solder paste.
If the amount of solder paste applied to the land is insufficient, the required adhesive strength cannot be obtained. If an excessive amount of solder paste is applied, solder bridging or flux overflow to the resistive element surface can occur.

2. Mounting

- (1) Use our standard land dimension. Excessive land area causes displacement due to the effect of the surface tension of the solder. Insufficient land area leads to insufficient soldering strength of the chip.
- (2) Do not apply excessive force (preferably 4.9N (Ref.: 500gf) max.), when the trimmer potentiometer is mounted to the PCB.
- (3) Do not warp and/or bend PC board to prevent trimmer potentiometer from breakage.
- (4) In chip placers, the size of the cylindrical pick-up nozzle should be outer dimension 2.5-3.0mm dia. and inner dimension 2.0-2.5mm dia..

3. Cleaning

- (1) Isopropyl-alcohol and Ethyl-alcohol are applicable solvents for cleaning. If you use any other types of solvents, please consult with a Murata factory representative prior to using.
- (2) Less than 3 minutes of total cleaning time by dipping, vapor and ultra-sonic method.
- (3) In case of ultra-sonic cleaning method, cleaning conditions should be as follows.
 - (a) Power: 600W (67lit.) max.
 - (b) Frequency: 28kHz
 - (c) Temperature: Ambient temperature
Due to ultra-sonic cleaning equipment's peculiar self-resonance point and that cleaning compatibility usually depends on the jig

Continued on the following page. 

PVG3 Series Notice

Continued from the preceding page.

construction and/or the cleaning condition such as the depth of immersion, please check the cleaning equipment to determine the suitable

conditions. If the condition is not suitable, the trimmer potentiometer may deviate from specified characteristics.

Reflow Soldering Standard Profile

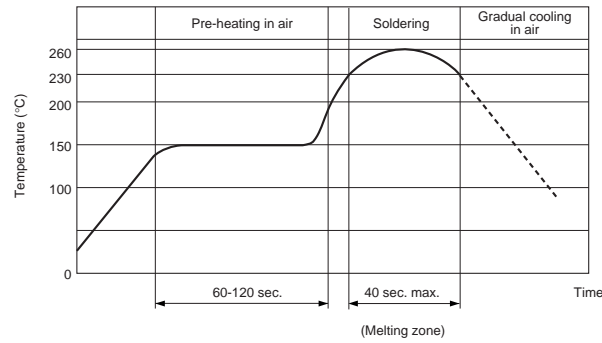

4

Notice (Handling)

1. Use suitable screwdrivers that fit comfortably in driver slot.

* Recommended screwdriver for manual adjustment
TORAY INDUSTRIES, INC. : SA-2225
(Murata P/N : KMDR070)

* Recommended screwdriver bit for automatic adjustment
TORAY INDUSTRIES, INC. : JB-2225
(Murata P/N : KMBT070)

We can supply the screwdrivers above.

If you place order, please specify the Murata P/N.

2. Don't apply more than 9.8N (Ref.; 1kgf) of twist and stress after mounting onto PCB to prevent contact intermittence.

3. When adjusting with an adjustment tool, the applied force to the adjustment screw should not exceed 4.9N (Ref.; 500gf). If excessive force is applied, the trimmer potentiometer may not function due to damage.

4. When using a lock paint to fix slot position, please use adhesive resin without chlorine or sulfur (Three-bond "1401 series").

Notice (Other)

1. Please make sure that your product has been evaluated and confirmed against your specifications when our product is mounted to your product.

2. Murata cannot guarantee trimmer potentiometer integrity when used under conditions other than those specified in this document.

SMD Sealed Type/Lead Sealed Type Specifications and Test Methods

The following describes trimmer potentiometer testing conducted by Murata Manufacturing Co., Ltd. in accordance with MIL-R-22097 (Military specification for variable resistors, non-wirewound) and MIL-STD-202 (Test methods for electronic and electrical component parts).

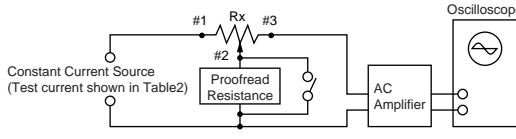
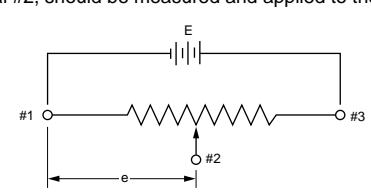
No.	Item	Test Methods																				
1	Total Resistance	<p>Measure total resistance between the resistance element and terminals (#1 and #3) with the contact arm positioned against a stop. The positioning of the contact arm and terminal should be the same for subsequent total resistance measurements on the same device. Use the test voltage specified in Table 1 for total resistance measurements. This voltage should be used for all subsequent total resistance measurements.</p> <table border="1"> <thead> <tr> <th>Total Resistance, Nominal (ohm)</th> <th>Maximum Test Voltage (V)</th> </tr> </thead> <tbody> <tr> <td>$10 \leq R \leq 100$</td> <td>1.0</td> </tr> <tr> <td>$100 < R \leq 1k$</td> <td>3.0</td> </tr> <tr> <td>$1k < R \leq 10k$</td> <td>10.0</td> </tr> <tr> <td>$10k < R \leq 100k$</td> <td>30.0</td> </tr> <tr> <td>$100k < R$</td> <td>100.0</td> </tr> </tbody> </table> <p>Table 1: Total resistance test voltage</p>	Total Resistance, Nominal (ohm)	Maximum Test Voltage (V)	$10 \leq R \leq 100$	1.0	$100 < R \leq 1k$	3.0	$1k < R \leq 10k$	10.0	$10k < R \leq 100k$	30.0	$100k < R$	100.0								
Total Resistance, Nominal (ohm)	Maximum Test Voltage (V)																					
$10 \leq R \leq 100$	1.0																					
$100 < R \leq 1k$	3.0																					
$1k < R \leq 10k$	10.0																					
$10k < R \leq 100k$	30.0																					
$100k < R$	100.0																					
2	Residual Resistance	<p>Position the contact arm at the extreme counterclockwise limit of mechanical travel and measure the resistance between the contact arm and the corresponding end terminal. Then, position the contact arm at the extreme clockwise limit of mechanical travel and measure the resistance between the contact arm and the corresponding end terminal. During this test, take suitable precautions to ensure that the rated current of the resistance element is not exceeded.</p>																				
3	Contact Resistance Variation	<p>Contact resistance variation should be measured with the measuring circuit shown in Figure 1, or its equivalent. The adjustment rotor (screw) should be rotated in both directions through 90% of the actual effective-electrical rotational angle (number of turns) for a total of 6 cycles. Only the last 3 cycles should count in determining whether or not a contact resistance variation is observed at least twice in the same location, exclusive of the roll-on or roll-off points where the contact arm moves from the termination, on or off, the resistance element. The rate of rotation of the adjustment rotor (screw) should be such that the adjustment rotor (screw) completes 1 cycle for 5 seconds minimum to 2 minutes maximum. The test current used should follow the value given in Table 2 unless otherwise limited by power rating.</p> <table border="1"> <thead> <tr> <th>Standard Total Resistance R (ohm)</th> <th>Test Current</th> </tr> </thead> <tbody> <tr> <td>$R \leq 100$</td> <td>20mA</td> </tr> <tr> <td>$100 < R < 500$</td> <td>10mA</td> </tr> <tr> <td>$500 \leq R < 1k$</td> <td>4mA</td> </tr> <tr> <td>$1k \leq R < 2k$</td> <td>2mA</td> </tr> <tr> <td>$2k \leq R < 50k$</td> <td>1mA</td> </tr> <tr> <td>$50k \leq R < 200k$</td> <td>200μA</td> </tr> <tr> <td>$200k \leq R < 1M$</td> <td>100μA</td> </tr> <tr> <td>$1M \leq R < 2M$</td> <td>50μA</td> </tr> <tr> <td>$2M \leq R$</td> <td>30μA</td> </tr> </tbody> </table> <p>Table 2: Test current for CRV</p>  <p>Rx : Trimmer Potentiometer Oscilloscope bandwidth : 100Hz to 50kHz</p> <p>Figure 1: CRV measuring circuit</p>	Standard Total Resistance R (ohm)	Test Current	$R \leq 100$	20mA	$100 < R < 500$	10mA	$500 \leq R < 1k$	4mA	$1k \leq R < 2k$	2mA	$2k \leq R < 50k$	1mA	$50k \leq R < 200k$	200μA	$200k \leq R < 1M$	100μA	$1M \leq R < 2M$	50μA	$2M \leq R$	30μA
Standard Total Resistance R (ohm)	Test Current																					
$R \leq 100$	20mA																					
$100 < R < 500$	10mA																					
$500 \leq R < 1k$	4mA																					
$1k \leq R < 2k$	2mA																					
$2k \leq R < 50k$	1mA																					
$50k \leq R < 200k$	200μA																					
$200k \leq R < 1M$	100μA																					
$1M \leq R < 2M$	50μA																					
$2M \leq R$	30μA																					
4	Temperature Coefficient of Resistance	<p>The trimmer potentiometer should be subjected to each of the following temperatures (see Table 3) for 30-45 minutes. Temperature coefficient of resistance should be applied to the following formula.</p> $TCR = \frac{R_2 - R_1}{R_1 (T_2 - T_1)} \times 10^6 \text{ (ppm/}^\circ\text{C)}$ <p>T₁ : Reference temperature in degrees celsius T₂ : Test temperature in degrees celsius R₁ : Resistance at reference temperature ohm R₂ : Resistance at test temperature in ohm</p> <table border="1"> <thead> <tr> <th>Sequence</th> <th>1*</th> <th>2</th> <th>3</th> <th>4*</th> <th>5</th> <th>6</th> </tr> </thead> <tbody> <tr> <td>Temperature (°C)</td> <td>+25</td> <td>-15</td> <td>Min. operating Temperature</td> <td>+25</td> <td>+65</td> <td>Max. operating Temperature</td> </tr> </tbody> </table> <p>Note*: Reference temperature</p> <p>Table 3: Test temperatures</p>	Sequence	1*	2	3	4*	5	6	Temperature (°C)	+25	-15	Min. operating Temperature	+25	+65	Max. operating Temperature						
Sequence	1*	2	3	4*	5	6																
Temperature (°C)	+25	-15	Min. operating Temperature	+25	+65	Max. operating Temperature																
5	Voltage Setting Stability	<p>The wiper should be set at approximately 40% of the actual effective-electrical rotational angle (number of turns). An adequate DC test potential should be applied between terminal #1 and terminal #3. The voltage between terminal #1 and terminal #3, and the voltage between terminal #1 and terminal #2, should be measured and applied to the following formula.</p> $\text{Voltage setting stability} = \left(\frac{e'}{E} - \frac{e}{E} \right) \times 100 \text{ (\%)}$ <p>e : Before test (The voltage between terminal #1 and terminal #2) e' : After test (The voltage between terminal #1 and terminal #2) E : The voltage between terminal #1 and terminal #3</p>  <p>Figure 2</p>																				

Continued on the following page. 

SMD Sealed Type/Lead Sealed Type Specifications and Test Methods

Continued from the preceding page.

No.	Item	Test Methods																
6	Temperature Cycle	<p>The trimmer potentiometer should be subjected to Table 4 temperature for 5 cycles. The trimmer potentiometer should be removed from the chamber, and maintained at a temperature of 25±5°C for 1~2 hours.</p> <table border="1"> <thead> <tr> <th>Sequence</th> <th>1</th> <th>2</th> <th>3</th> <th>4</th> </tr> </thead> <tbody> <tr> <td>Temp. (°C)</td> <td>PV□□ series PV22 series PVF2 series</td> <td>-55±3</td> <td>+25±2</td> <td>+125±3 +150±3 +60±3</td> <td>+25±2</td> </tr> <tr> <td>Time (min.)</td> <td>30</td> <td>5 max.</td> <td>30</td> <td>5 max.</td> </tr> </tbody> </table> <p>Table 4: One cycle of temperature cycle.</p>	Sequence	1	2	3	4	Temp. (°C)	PV□□ series PV22 series PVF2 series	-55±3	+25±2	+125±3 +150±3 +60±3	+25±2	Time (min.)	30	5 max.	30	5 max.
Sequence	1	2	3	4														
Temp. (°C)	PV□□ series PV22 series PVF2 series	-55±3	+25±2	+125±3 +150±3 +60±3	+25±2													
Time (min.)	30	5 max.	30	5 max.														
7	Humidity	<p>1) PVC6, PV12, PV32, PV34 PVM4A□□□D01 series The trimmer potentiometer should be placed in a chamber at a temperature of 40±2°C and a humidity of 90~95% without loading for 250±8 hours (500±12 hours for PVM4A□□□D01 series). The trimmer potentiometer should be removed from the chamber, and maintained at a temperature of 25±5°C for 5±1/6 hours.</p> <p>2) PVF2 series The trimmer potentiometer should be placed in a chamber at 60±2°C and 90~95% without loading for 1000±12 hours. The trimmer potentiometer should be removed from the chamber, and maintained at a temperature of 25±5°C for 5±1/6 hours</p> <p>2) PVG3, PVG5, PV01, PV22, PV23, PV36, PV37 series The trimmer potentiometer should be subjected Figure-3 the programmed humidity environment for 10 cycle. The trimmer potentiometer should be removed from the chamber, and maintained at a temperature of 25±5°C for 1.5±1/2 hours.</p> <p>Figure 3</p>																
8	Vibration	<p>1) PV□□ series The trimmer potentiometer should be vibrated throughout the frequency range at the 20G level. A complete frequency range, 10Hz to 2000Hz and back, should be made within 15 minutes for a total of 4 sweeps in each of the three axis direction for a total of 12 sweeps.</p> <p>2) PVF2 series The trimmer potentiometer should be subjected to vibration at 0.3 inch amplitude. The frequency should be varied uniformly between the approximate limits of 10Hz and 55Hz. This motion should be applied for period of 2 hours in each of 3 mutually perpendicular directions (total of 6 hours).</p>																
9	Shock	<p>1) PV□□ series The trimmer potentiometer should be shocked at the 100G (50G for PV22 and PV23 series) level and should be subjected to 4 shocks in each of the three axis directions for a total of 12 shocks.</p> <p>2) PVM4A□□□D01 series The trimmer potentiometer should be shocked at the 100G level and should be subjected to 3 shocks in each of the six axis directions for a total of 18 shocks.</p>																
10	Temperature Road Life	<p>Full rated continuous working voltage not exceeding the maximum rated voltage should be applied intermittently between terminal #1 and terminal #3 of the trimmer potentiometer, 1.5 hours on and 0.5 hours off, for a total of 1000±12 hours, at a temperature of 70±2°C (85±2°C for PV01 and PV37 series, 50±2°C for PVF2 series). The trimmer potentiometer should be removed from the chamber, and maintained at a temperature of 25±5°C for 1 to 2 hours.</p>																
11	High Temperature Exposure (Except for PVF2)	<p>The trimmer potentiometer should be placed in a chamber at a temperature of 125±3°C (150±3°C for PV22 series) 250±8 hours without loading. The trimmer potentiometer should be removed from the chamber, and maintained at a temperature of 25±5°C for 1 to 2 hours.</p>																
12	Low Temperature Exposure (Except for PVF2 and PVM4A□□□D01)	<p>The trimmer potentiometer should be placed in a chamber at a temperature of -55±3°C for 1 hours without loading. Full rated continuous working voltage not exceeding the maximum rated voltage should be applied for 45 minutes. The trimmer potentiometer should be removed from the chamber, and maintained at a temperature of 25±5°C for approximately 24 hours.</p>																

Continued on the following page. ↗

SMD Sealed Type/Lead Sealed Type Specifications and Test Methods

↳ Continued from the preceding page.

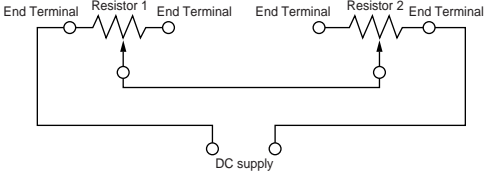
No.	Item	Test Methods
13	Low Temperature Operation (Only for PVF2 and PVM4□□□D01)	The trimmer potentiometer should be placed in a chamber at a temperature of $-25\pm 3^{\circ}\text{C}$ ($-55\pm 3^{\circ}\text{C}$ for PVM4□□□D01 series) 48 ± 4 hours without loading. The trimmer potentiometer should be removed from the chamber, and maintained at a temperature of $25\pm 5^{\circ}\text{C}$ for 1-2 hours
14	Rotational Life	<p>1) PV□□ series Full rated continuous working voltage not exceeding the maximum rated voltage should be applied with the circuit shown in the figure. The adjustment rotor (screw) should be continuously cycled through not less than 90% of effective-electrical rotational angle (number of turns), at the rate of 1 cycle for 5 seconds minimum to 2.5 minutes maximum for total of 200 cycles.</p> <div style="text-align: center;">  <p>Figure 4</p> </div> <p>2) PVG3, PVG5 series The adjustment rotor (screw) should be continuously cycled though not less than 90% of effective-electrical rotational angle (number of turns), at the rate of 1 cycle for 5 seconds minimum to 2.5 minutes maximum for a total of 50 (100 for PVG5) cycles, without loading.</p> <p>3) PVF2, PVM4□□□D01 series The wiper should be rotated over 90% of the effective rotational angle without loading at a speed of 10 cycles per minute, for 100 cycles continuously.</p>