

# LTC1174 High Efficiency Step-Down DC/DC Converter

## DESCRIPTION

This demonstration circuit is a step-down (buck) regulator using the high voltage LTC<sup>®</sup>1174. Exclusive use of surface mount components results in a highly efficient application in a small board space. This demo board highlights the simplicity of the LTC1174 in stepping down input voltages ranging between 4V to 16.5V. The LTC1174 is a current mode DC/DC converter, thus the peak inductor current is well-defined and provides excellent transient response. To optimize efficiency, the LTC1174 automatically switches between continuous and Burst Mode™

operation. To further optimize the LTC1174 for a wide range of applications, the maximum inductor current is pin selectable to either 340mA or 600mA. The part can also be shut down, drawing a mere 1μA, making this part ideal for current sensitive applications. An onboard low battery detector allows the user to monitor the input supply through an external resistive divider. This divided voltage is compared with an internal 1.25V reference voltage. **Gerber files for this circuit board are available. Call the LTC factory.**

LT, LTC and LT are registered trademarks of Linear Technology Corporation. Burst Mode is a trademark of Linear Technology Corporation.

## PERFORMANCE SUMMARY

SYMBOL	PARAMETER	CONDITIONS	BOARD SUFFIX	VALUE
V <sub>IN</sub>	Input Voltage Range		ALL	4V to 16.5V
V <sub>OUT</sub>	Output Voltage	LTC1174HV-5 LTC1174HV-3.3 LTC1174HV, R1=54.9K, R2=33.3K	A B C	5.0V ± 0.15V 3.3V ± 0.10V 3.3V ± 0.10V
I <sub>OUT</sub>	Maximum Output Current	I <sub>PGM</sub> = V <sub>IN</sub> , V <sub>OUT</sub> = 5.0V I <sub>PGM</sub> = 0V, V <sub>OUT</sub> = 5.0V I <sub>PGM</sub> = V <sub>IN</sub> , V <sub>OUT</sub> = 3.3V I <sub>PGM</sub> = 0V, V <sub>OUT</sub> = 3.3V I <sub>PGM</sub> = V <sub>IN</sub> , V <sub>OUT</sub> = 3.3V I <sub>PGM</sub> = 0V, V <sub>OUT</sub> = 3.3V	A A B B C C	380mA 125mA 400mA 130mA 375mA 130mA
V <sub>RIPPLE</sub>	Typical Output Ripple		A & B C	80mVp-p 40mVp-p

## TYPICAL PERFORMANCE CHARACTERISTICS AND BOARD PHOTO

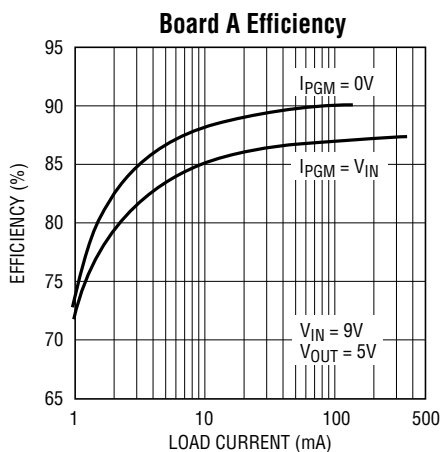

DC059 • G01

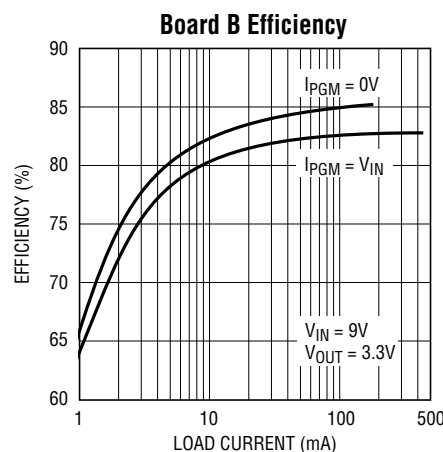

DC059 • G02

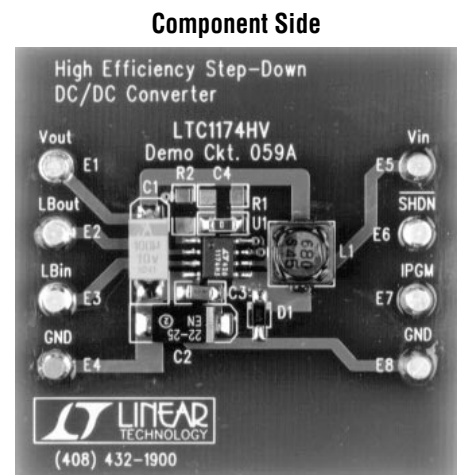

## PERFORMANCE SUMMARY

SYMBOL	PARAMETER	CONDITIONS	BOARD SUFFIX	VALUE
DV <sub>OUT</sub>	Typical Line Regulation	6V < V <sub>IN</sub> < 16.5V, I <sub>LOAD</sub> = 350mA, I <sub>PGM</sub> = V <sub>IN</sub> 6V < V <sub>IN</sub> < 16.5V, I <sub>LOAD</sub> = 125mA, I <sub>PGM</sub> = 0V	ALL ALL	25mV 7mV
	Typical Load Regulation	20mA < I <sub>LOAD</sub> < 350mA, I <sub>PGM</sub> = V <sub>IN</sub> , V <sub>IN</sub> = 9V 20mA < I <sub>LOAD</sub> < 125mA, I <sub>PGM</sub> = 0V, V <sub>IN</sub> = 9V	ALL ALL	10mV 8mV
V <sub>LBTRIP</sub>	Low-Battery Trip Point		ALL	1.25V
V <sub>IH</sub>	SHUTDOWN Pin High	Minimum Voltage at Pin 8 for Device to Be Active	ALL	1.2V
V <sub>IL</sub>	SHUTDOWN Pin Low	Maximum Voltage at Pin 8 for Device to Be in Shutdown	ALL	0.75V
I <sub>Q</sub>	Typical Input DC Supply Current	Active Mode, 4V < V <sub>IN</sub> < 16.5 V, I <sub>PGM</sub> = 0V	ALL	450μA
		Sleep Mode, 4V < V <sub>IN</sub> < 16.5V	ALL	130μA
		V <sub>SHUTDOWN</sub> = 0, 4V < V <sub>IN</sub> < 16.5V	ALL	1μA

## PACKAGE AND SCHEMATIC DIAGRAMS

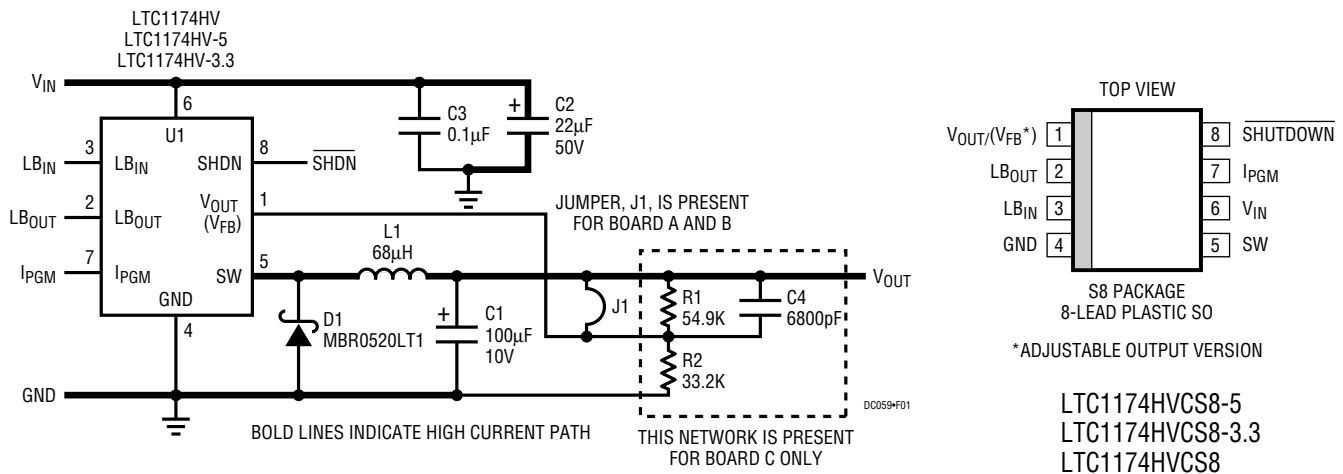

## PARTS LIST

REFERENCE DESIGNATOR	QUANTITY	PART NUMBER	DESCRIPTION	VENDOR	TELEPHONE
C1	1	TPSD107K010	Cap, Tant, 100μF, 10V, 20%	AVX	(803) 448-9411
C2	1	TPSD226K025	Cap, Tant, 22μF, 25V, 10%	AVX	
C3	1	12065C104KAT	Cap, Mono Chip, 0.1μF, 50V, 10%	AVX	
C4	1	VJ1206Y682KXBT	Cap, CER Chip, 6800pF, 100V	Vitramon	(203) 268-6261
D1	1	MBR0520LT1	Schottky Diode	Motorola	(602) 244-3558
L1	1	CDRH74-680	Inductor, 68μH	Sumida	(708) 956-0666
R1	1	CR325492FT	54.9kΩ, 1%	AVX	(803) 448-9411
R2	1	BCR1/83322FT	33.2kΩ, 1%	Beckman Industrial	(714) 447-2345
J1	1	CJ32-000-T	0Ω, Jumper	AVX	
U1	1	LTC1174HVCS8-5 LTC1174HVCS8-3.3 LTC1174HVCS8	IC, LTC1174HV-5 Board A IC, LTC1174HV-3.3 Board B IC, LTC1174HV Board C	LTC	(408) 432-1900

## QUICK START GUIDE

This demonstration board is simple to use. Just follow the steps outlined below and you are ready to start your evaluation of the LTC1174.

- Connect your power supply between the  $V_{IN}$  terminal and GND terminal.
- Connect the SHDN pin to a voltage greater than 1.2V for the part to be active. This pin can also be shorted to  $V_{IN}$  pin. **DO NOT FLOAT THIS PIN AS THIS MAY RESULT IN INTERMITTENT OPERATION OF THE PART.**

- Connect the  $I_{PGM}$  pin either to GND or  $V_{IN}$  depending upon the amount of current you want to source from the part. Again, **DO NOT FLOAT THIS PIN.**
- The  $LB_{OUT}$  pin is a current sinking pin. When the  $LB_{IN}$  pin goes below 1.25V, the  $LB_{OUT}$  pin will sink 1mA of current.
- The  $LB_{IN}$  pin is the low battery detector input pin. Normally, its input comes from the input voltage through a resistor divider network (see Low Battery Detector section).

## OPERATION

The circuit shown in Figure 1 operates between input voltages of 4V and 16.5V. For the regular fixed 3.3V or 5V version, the external components are the same except for U1. For the low noise demonstration circuit, it requires an adjustable version for U1 and an additional passive network.

This demonstration unit is intended for the evaluation of the LTC1174 switching regulator IC and was not designed for any other purpose.

## OPERATION

The LTC1174 uses a constant off-time architecture to switch its internal P-channel power MOSFET. The off-time is set by an internal timing capacitor and the operating frequency is a function of  $V_{IN}$ .

The output voltage is set by an internal resistive divider. A voltage comparator (A1) compares the divided output voltage to a reference voltage of 1.25V.

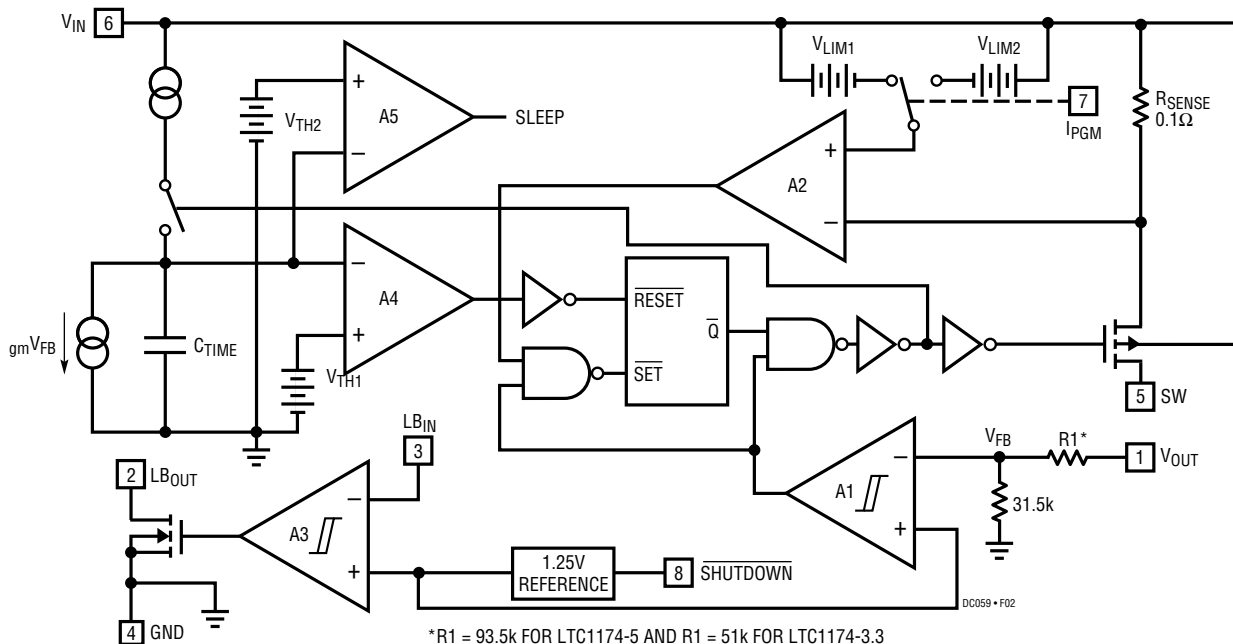

Figure 2. LTC1174 Block Diagram

## OPERATION

To optimize efficiency, the LTC1174 automatically switches between two modes of operation, burst and continuous. The voltage comparator is the primary control element when the device is in Burst Mode operation, while the current comparator controls the output voltage in continuous mode.

During the switch ON time, switch current flows through the 0.1Ω sense resistor. When this current reaches the threshold of the current comparator A2, its output signal will change state, setting the flip-flop and turning the switch off. The timing capacitor, C<sub>TIME</sub>, begins to discharge until its voltage goes below V<sub>TH1</sub>. Comparator A4 will then trip, which resets the flip-flop and causes the switch to turn on again. Also, the timing capacitor is recharged. The inductor current will again ramp up until the current comparator A2 trips. The cycle then repeats.

When the load is relatively light, the LTC1174 automatically goes into Burst Mode operation. The current mode loop is interrupted when the output voltage reaches the desired regulated value. The hysteretic voltage comparator A1 trips when V<sub>OUT</sub> is above the desired output voltage, shutting off the switch and causing the timing capacitor to discharge. This capacitor discharges past V<sub>TH1</sub> until its voltage drops below V<sub>TH2</sub>. Comparator A5 then trips and a sleep signal is generated.

In sleep mode, the LTC1174 is inactive and the load current is supplied by the output capacitor. All unused circuitry is shut off, reducing quiescent current from 0.45mA to 0.13mA. When the output capacitor discharges by the amount of the hysteresis of the comparator A1, the P-channel switch turns on again and the process repeats itself.

### LOW NOISE REGULATOR

In some applications, it is important not to introduce any switching noise within the audio frequency range. Due to the Burst Mode operation nature of the LTC1174, there is a possibility that the regulator will introduce audio noise at some load currents. To circumvent this problem, a feed-forward capacitor can be used to shift the noise spectrum up and out of the audio band. Board C has been

configured for this application. The peak-to-peak output ripple is reduced to 40mV over the entire load range. A toroidal surface mount inductor is chosen for its excellent self-shielding properties. Open magnetic structures such as drum and rod cores are to be avoided since they inject high flux levels into their surroundings. This can become a major source of noise in any converter circuit. Figure 3 shows the efficiency curve of Board C.

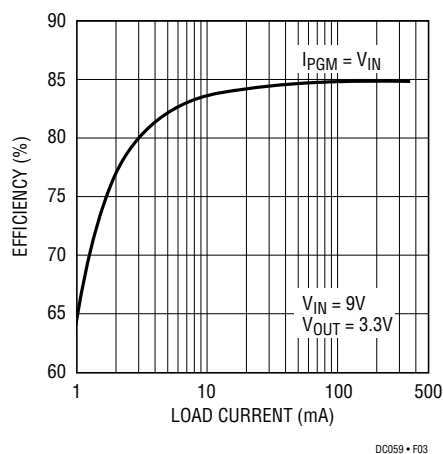

Figure 3. Board C Efficiency

### LOW BATTERY DETECTOR

The low battery indicator senses the input voltage through an external resistive divider. This divided voltage connects to the (-) input of a voltage comparator (Pin 3) which is compared with a 1.25V reference voltage. With the current going into Pin 3 being negligible, the following expression is used for setting the trip limit:

$$V_{LB\_TRIP} = 1.25 \left( 1 + \frac{R4}{R3} \right)$$

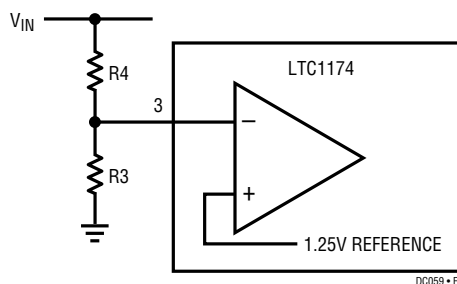

Figure 4. Low Battery Comparator

## OPERATION

### Inductors

To most engineers inductors are the least familiar component in a switching power supply. This is unfortunate because the most flexible component in the system is the inductor. The size, shape, efficiency, form factor and cost are variables that can be traded-off against one another. The only fixed requirement of the inductor used with the LTC1174 is that it must be able to support the output DC current and still maintain its inductance value.

Although the demonstration circuit uses an inductor from Sumida, the user can easily replace it with some minor soldering, with any inductor from other vendors. The CDRH74 series coil was chosen because of its shielded core and lower cost but at the expense of lower efficiency. (See Figure 5 and 6 for comparison of efficiency with other coil). Therefore it is important that you need to know your requirement and optimize your design in terms of cost and/or efficiency of your circuit.

### HOW TO MEASURE VOLTAGE REGULATION

When trying to measure voltage regulation, remember that all measurements must be taken at the point of regulation. This point is where the LTC1174's control loop looks for the information to keep the output voltage constant. In this demonstration board, this information point occurs between Pin 4 and Pin 1 of the LTC1174 for Board A and B, while Board C has to be taken from the common node of the inductor and R1. These points

correspond to the output terminals of the board. Test leads should be attached to these terminals. **Measurements should not be taken at the end of test leads at the load.**

This applies to line regulation (input to output voltage regulation) as well as load regulation tests. In doing line regulation tests always look at the input voltage across the input terminals.

For the purposes of these tests, the demonstration circuit should be fed from a regulated DC bench supply so additional variation on the DC input does not add an error to the regulation measurements.

### RIPPLE MEASUREMENT

For the purpose of measuring output ripple it is best to measure directly across the output terminals.

As in the regulation tests, the supply must be fed from a regulated DC source so that ripple on the input to the circuit under test does not add to the output ripple, causing errors in the measurement.

The technique used to measure the ripple is also important. Here is a list of things to do and not to do when using a scope probe:

1. DO NOT USE THE GROUND LEADS/CLIPS THAT ARE ATTACHED TO THE SCOPE PROBE!
2. DO ATTACH THE SHIELD OF THE PROBE BODY TO THE NEGATIVE SIDE OF THE OUTPUT CAPACITOR! DO NOT USE WIRE!

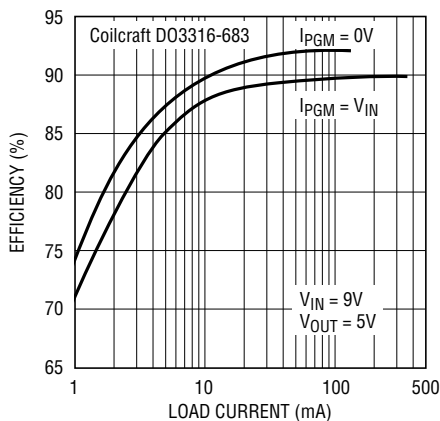

Figure 5. Demo Board Efficiency for 5V Output Using Coilcraft Inductor

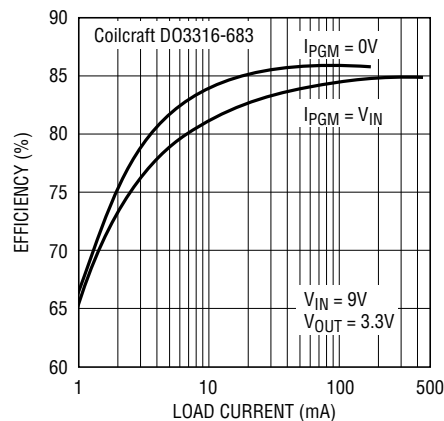

Figure 6. Demo Board Efficiency for 3.3V Output Using Coilcraft Inductor

## OPERATION

3. DO NOT PUT THE TIP OF THE SCOPE PROBE DIRECTLY ON THE POSITIVE TERMINAL OF THE OUTPUT CAPACITOR.
4. DO NOT USE A PROBE WHOSE BODY IS NOT COMPLETELY SHIELDED.

Any unshielded lead, such as a ground lead on a scope probe, acts as an antenna for the switching noise in the supply. Therefore any use of a ground lead will invalidate the measurement.

Be extremely careful to ensure that other sources of noise do not invalidate the measurement. Noise from the 60Hz power line that feeds the bench power supply powering the LTC1174 demonstration board can cause errors in the measurement. This noise (especially spikes) can propagate through measurement and it can also propagate through the bench supply and appear on the ground of the demonstration unit. If this is a problem, a battery can be used to power the unit for ripple tests.

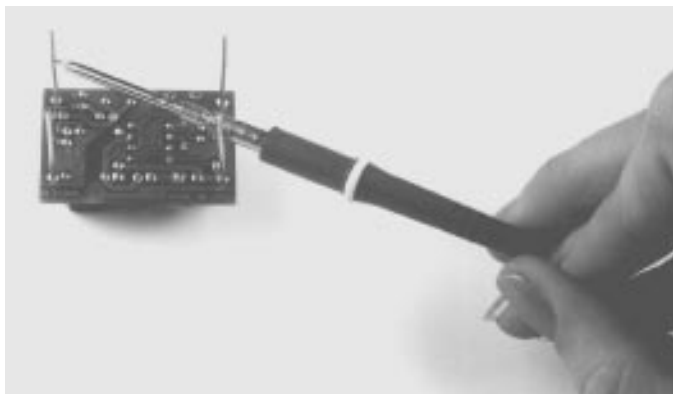

Figure 7. Scope Probe and Typical Measurement Set-Up

Also be wary of ground loops. The input DC supply should float and the only ground should be that of the scope probe. Never float the oscilloscope as it may present a safety hazard.

An alternate technique is to take a 50Ω or 75Ω piece of coax and solder the leads directly to the output capacitor. Keep the shield over the center conductor for as great a distance as possible. The center conductor can pick up stray radiation when it is not shielded, so minimize the length of the exposed center conductor. The other end of the coax should have a BNC connector for attaching to the oscilloscope.

### Checking Transient Response

Switching regulators take several cycles to respond to a step in DC (resistive) load current. When a load step occurs,  $V_{OUT}$  shifts by an amount equal to  $\Delta I_{LOAD}$  (ESR) (Effective Series Resistance) of  $C_{OUT}$ .  $\Delta I_{LOAD}$  also begins to charge or discharge  $C_{OUT}$  until the regulator loop adapts to the current change and returns  $V_{OUT}$  to its steady-state value. During this recovery time  $V_{OUT}$  can be monitored for overshoot or ringing which would indicate a stability problem. The external components shown in the Figure 1 circuit will prove adequate for most applications.

A second, more severe transient is caused by switching in loads with large ( $>1\mu F$ ) supply bypass capacitors. The discharged bypass capacitors are effectively put in parallel with  $C_{OUT}$ , causing a rapid drop in  $V_{OUT}$ . No regulator can deliver enough current to prevent this problem if the load switch resistance is low and it is driven quickly. The only solution is to limit the rise time of the switch drive so that the load rise time is limited to approximately  $25(C_{LOAD})$ . Thus a  $10\mu F$  capacitor would require a  $250\mu s$  rise time, limiting the charging current to about 200mA.

### Components

Components selection can be very critical in switching power supply applications. This section discusses some of the guidelines for selecting the different components. The LTC1174 data sheet details more specific selection criteria for most of the external components surrounding the IC. Be sure to refer to the data sheet if changes to this demo circuit are anticipated.



## OPERATION

### Capacitors

The most common component uncertainty with switching power supplies involves capacitors. In this circuit (refer to Figure 1) C1 and C2 are all specially developed low ESR, high ripple-current tantalum capacitors specifically designed for use in switching power supplies. ESR is the parasitic series resistance in the capacitor. Very often this resistance is the limiting element in reducing ripple at the output or input of the supply. Standard wet electrolytics may cause the feedback loop to be unstable (this means your power supply becomes an oscillator). They may also cause poor transient response or have a limited operating life. Standard parts normally do not have an ESR specification at high frequencies (100kHz) so, although you may find a part that works to your satisfaction in a prototype, **the same part may not work consistently in production.** Furthermore, surface mount versions of wet electrolytics are not space efficient, and they may have high ESR and limited lifetimes.

Normal tantalums are not recommended for use in these applications (most notably the low cost ones) as they do not have the ability to take the large peak currents that are required for the application. Tantalums have a failure mechanism whereby they become a low value resistance or short. Wet electrolytics rarely short; they usually fail by going high impedance if over stressed. Very few tantalum manufacturers have the ability to make capacitors for power applications.

There are some tantalums, such as those used in this design, that are specifically designed for switching power supplies. They are much smaller than wet electrolytic capacitors and are surface mountable but they do cost more.

One other choice that fits between wet electrolytics and tantalums is organic semiconductor type capacitors (OS-CON) that are specifically made for power supply applications. They are very low ESR and are 1/2 the size of an equivalent wet electrolytic.

### Components Manufacturer

Besides those components that are used on the demonstration board, other components may also be used. Below is a partial list of the manufacturers whose components you can use for the switching regulator. Using components, other than the ones on the demonstration board, require re-characterizing the circuit for efficiency.

**Table 1. Inductor Manufacturer**

MANUFACTURER	PART NUMBERS
Coilcraft 1102 Silver Lake Road Cary, Illinois (Phone) 708-639-6400 (Fax) 708-639-1469	DT3316 Series
Coiltronics International 6000 Park of Commerce Blvd Boca Raton, FL 33487 (Phone) 407-241-7876 (Fax) 407-241-9339	Econo-Pac Octa-Pac
Dale Electronics Inc. E. Highway 50 P.O. Box 180 Yankton, SD 57078-0180 (Phone) 605-665-9301 (Fax) 605-665-1627	LPT4545
Sumida Electric Co. Ltd. 5999 New Wilke Rd., Suite #110 Rolling Meadows, IL 60008 (Phone) 708-956-0666 (Fax) 708-956-0702	CD 54 Series CDR 74H Series

**Table 2. Capacitor Manufacturers**

MANUFACTURER	PART NUMBERS
AVX Corporation P.O. Box 887 Myrtle Beach, SC 29578 (Phone) 803-448-9411 (Fax) 803-448-1943	TPS Series
Sanyo Video Components 2001 Sanyo Avenue San Diego, CA 92071 (Phone) 619-661-6322 (Fax) 619-661-1055	OS-CON Series
Sprague 678 Main Street Sanford, ME 04073 (Phone) 207-324-4140 (Fax) 207-324-7223	593D Series

# DEMO MANUAL DC059

## PCB LAYOUT AND FILM

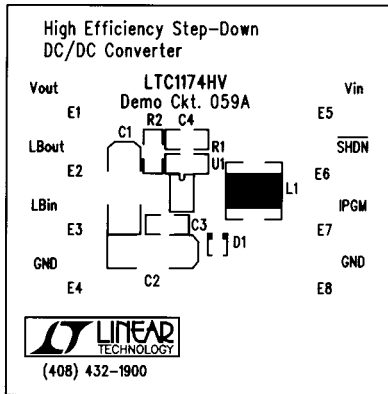

Component Side Silkscreen

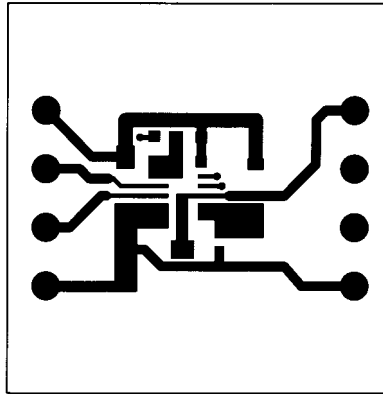

Component Side

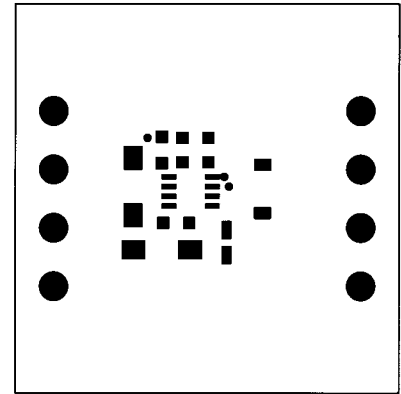

Component Side Solder Mask

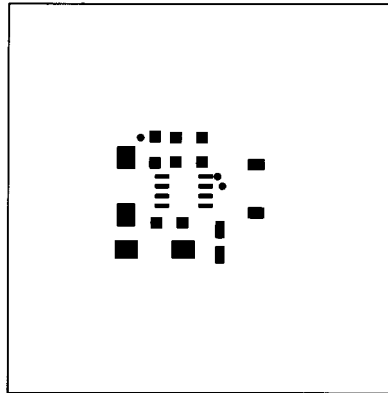

Solder Side Silkscreen

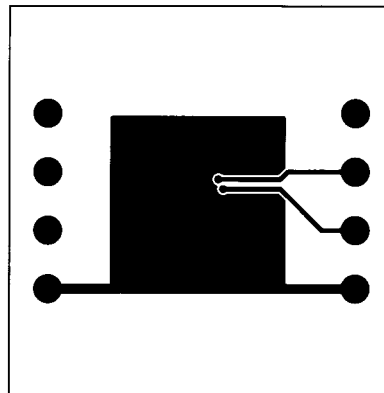

Solder Side

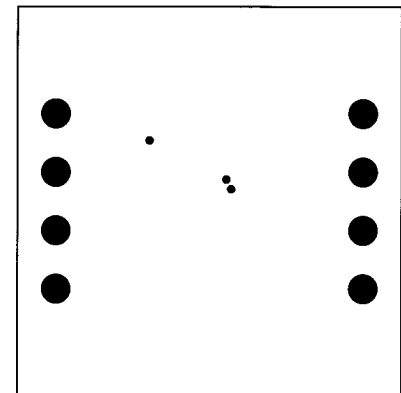

Solder Side Solder Mask

## PC FAB DRAWING

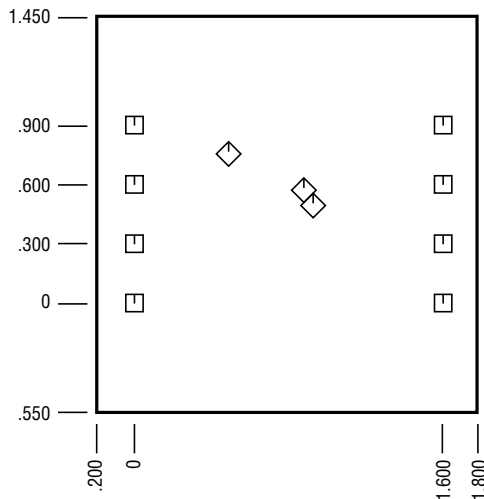

- NOTES: UNLESS OTHERWISE SPECIFIED.
1. MATERIAL: 2 LAYERS, 0.062" THK. FR-4 GLASS EPOXY 2 OZ. COPPER CLAD.
  2. ALL HOLES SHALL BE PLATED THRU.
  3. PLATE THRU HOLES WITH COPPER .0014 MIN. THICKNESS.  
ALL HOLE SIZES IN HOLE TABLE ARE AFTER PLATING.
  4. SILKSCREEN: WITH WHITE EPOXY NON-CONDUCTIVE INK.
  5. FINISH: ELECTRODEPOSITED TIN-LEAD COMPOSITION.  
BEFORE REFLOW, SOLDER MASK OVER BARE COPPER (SMOBC).
  6. SOLDER MASK: USED FILM PROVIDED BLUE OR GREEN.

SIZE	QTY	SYM	PLTD
94	8	□	x
13	3	◇	x

DC059 • PCB01