



3-terminal Filters, SMD Array

For high-speed signal line (cellular band compatible)

MEA-D/-PH series

MEA1210D	1210[0504 inch]*
MEA1210PH	1210[0504 inch]
MEA1608PH	1608[0603 inch]

* Dimensions Code JIS[EIA]

REMINDERS FOR USING THESE PRODUCTS

Before using these products, be sure to request the delivery specifications.

SAFETY REMINDERS

Please pay sufficient attention to the warnings for safe designing when using these products.

REMINDERS

- The storage period is less than 12 months. Be sure to follow the storage conditions (Temperature: 5 to 40°C, Humidity: 10 to 75% RH or less).
If the storage period elapses, the soldering of the terminal electrodes may deteriorate.
- Do not use or store in locations where there are conditions such as gas corrosion (salt, acid, alkali, etc.).
- Before soldering, be sure to preheat components.
The preheating temperature should be set so that the temperature difference between the solder temperature and chip temperature does not exceed 150°C.
- Soldering corrections after mounting should be within the range of the conditions determined in the specifications.
If overheated, a short circuit, performance deterioration, or lifespan shortening may occur.
- When embedding a printed circuit board where a chip is mounted to a set, be sure that residual stress is not given to the chip due to the overall distortion of the printed circuit board and partial distortion such as at screw tightening portions.
- Self heating (temperature increase) occurs when the power is turned ON, so the tolerance should be sufficient for the set thermal design.
- Carefully lay out the coil for the circuit board design of the non-magnetic shield type.
A malfunction may occur due to magnetic interference.
- Use a wrist band to discharge static electricity in your body through the grounding wire.
- Do not expose the products to magnets or magnetic fields.
- Do not use for a purpose outside of the contents regulated in the delivery specifications.
- The products listed on this catalog are intended for use in general electronic equipment (AV equipment, telecommunications equipment, home appliances, amusement equipment, computer equipment, personal equipment, office equipment, measurement equipment, industrial robots) under a normal operation and use condition.
The products are not designed or warranted to meet the requirements of the applications listed below, whose performance and/or quality require a more stringent level of safety or reliability, or whose failure, malfunction or trouble could cause serious damage to society, person or property.
If you intend to use the products in the applications listed below or if you have special requirements exceeding the range or conditions set forth in the each catalog, please contact us.

- (1) Aerospace/Aviation equipment
- (2) Transportation equipment (cars, electric trains, ships, etc.)
- (3) Medical equipment
- (4) Power-generation control equipment
- (5) Atomic energy-related equipment
- (6) Seabed equipment
- (7) Transportation control equipment

- (8) Public information-processing equipment
- (9) Military equipment
- (10) Electric heating apparatus, burning equipment
- (11) Disaster prevention/crime prevention equipment
- (12) Safety equipment
- (13) Other applications that are not considered general-purpose applications

When designing your equipment even for general-purpose applications, you are kindly requested to take into consideration securing protection circuit/device or providing backup circuits in your equipment.

3-terminal Filters, SMD Array

For high-speed signal line (cellular band compatible)

Product compatible with RoHS directive
Halogen-free
Compatible with lead-free solders

Overview of the MEA-D/-PH Series

FEATURES

- Single chip for 2-line or 4-line filters, and compatible with high-density mounting.
- Compact with a low profile design.
- Effective as a desensitization countermeasure in information transmission terminals such as smart phones.
- Can be used for signal lines of mobile device displays.

MEA1210D

- Low strain to signal waveforms after passing the filter.

APPLICATION

Noise removal from signal lines of smart phones, digital cameras, PCs, game machines, flat TVs, etc.

PART NUMBER CONSTRUCTION

MEA	1210		D	301R		T		□□□
Series name	LxWxT Dimensions (mm)		Product internal code	Cutoff frequency (MHz)		Packaging style		Internal code
	1210	1.2×1.0×0.5	D	301R	300	T	Taping	
	1608	1.6×0.8×0.5	PH	501R	500			
				Capacitance (pF)				
				150	15			
				270	27			

MEA1210PH and MEA1608PH only

OPERATING TEMPERATURE RANGE, PACKAGE QUANTITY, PRODUCT WEIGHT

Type	Temperature range		Package quantity	Individual weight
	Operating temperature	Storage temperature*		
	(°C)	(°C)	(pieces/reel)	(mg)
MEA1210D	-40 to +85	-40 to +85	4,000	3
MEA1210PH	-40 to +85	-40 to +85	4,000	3
MEA1608PH	-40 to +85	-40 to +85	4,000	3.5

* The Storage temperature range is for after the circuit board is mounted.

- RoHS Directive Compliant Product: See the following for more details related to RoHS Directive compliant products. <http://www.tdk.co.jp/rohs/>
- Halogen-free: Indicates that Cl content is less than 900ppm, Br content is less than 900ppm, and that the total Cl and Br content is less than 1500ppm.

• All specifications are subject to change without notice.

Overview of the MEA-D/-PH Series

RECOMMENDED REFLOW PROFILE



Preheating			Soldering		Peak	
Temp.		Time	Temp.	Time	Temp.	Time
T1	T2	t1	T3	t2	T4	t3
150°C	180°C	60 to 120s	230°C	30 to 60s	250 to 260°C	10s max.

• All specifications are subject to change without notice.

MEA-D series

MEA1210D Type



SHAPE & DIMENSIONS

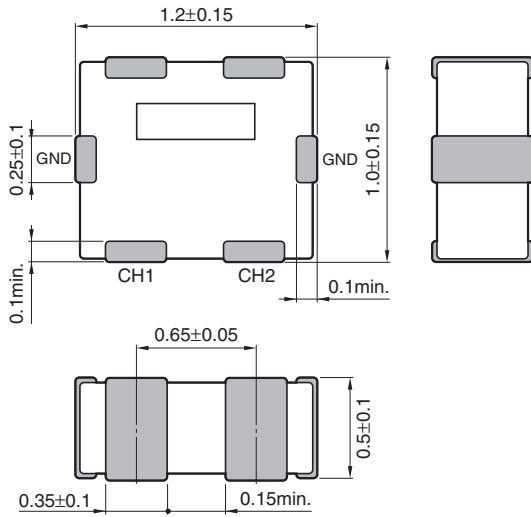

Dimensions in mm

RECOMMENDED LAND PATTERN

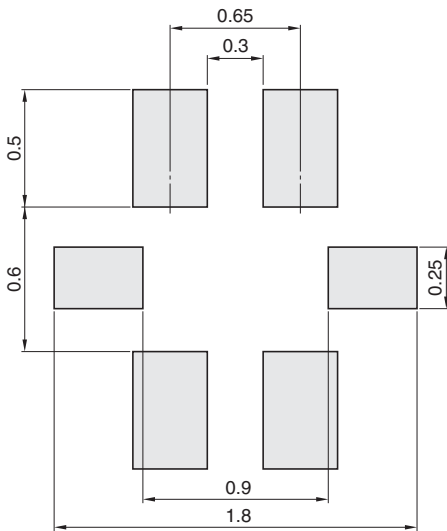

Dimensions in mm

CIRCUIT DIAGRAM

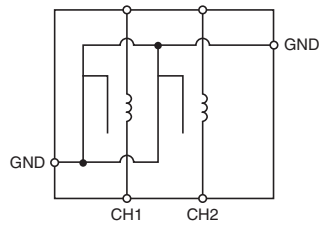

• All specifications are subject to change without notice.

MEA-D series MEA1210D Type

ELECTRICAL CHARACTERISTICS

CHARACTERISTICS SPECIFICATION TABLE

Cutoff frequency (MHz)typ.	Insertion loss 20dB frequency range (MHz)	Rated voltage (V)max.	Rated current (mA)max.	Part No.
300	700 to 2000	10	100	MEA1210D301RT□□□
400	900 to 2000	10	100	MEA1210D401RT□□□
500	1500 to 3000	10	100	MEA1210D501RT□□□

○ Measurement equipment

Measurement item	Product No.	Manufacturer
Frequency characteristics	N5230C	Agilent Technologies

* Equivalent measurement equipment may be used.

INSERTION LOSS VS. FREQUENCY CHARACTERISTICS

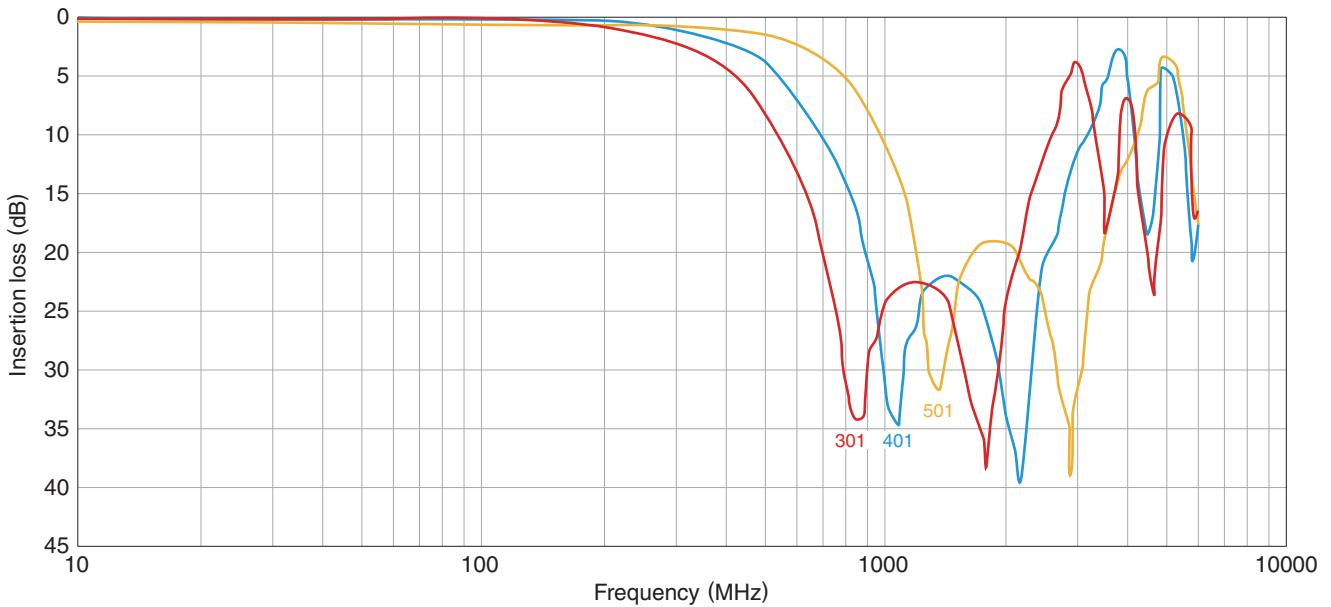

○ Measurement equipment

Product No.	Manufacturer
N5230C	Agilent Technologies

* Equivalent measurement equipment may be used.

• All specifications are subject to change without notice.

MEA-PH series

MEA1210PH Type



SHAPE & DIMENSIONS

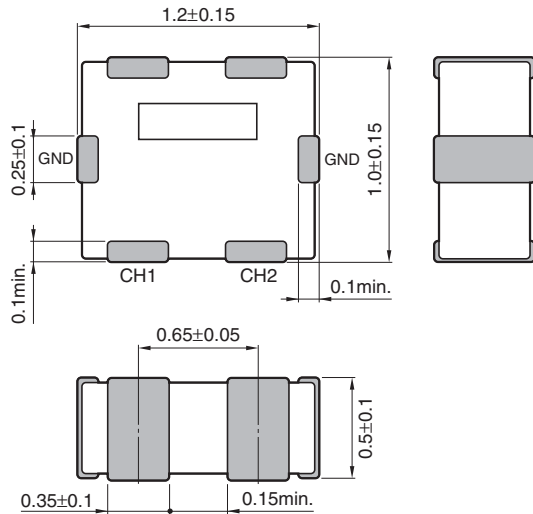

Dimensions in mm

RECOMMENDED LAND PATTERN

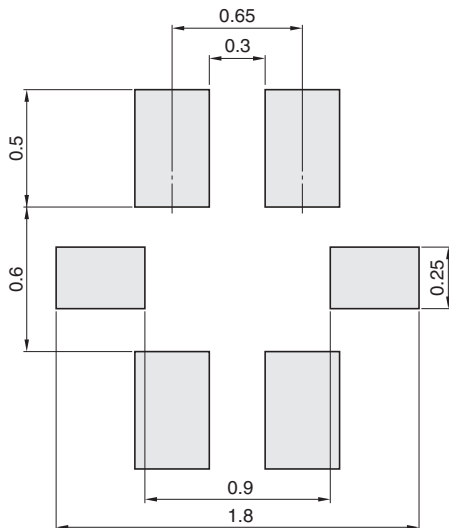

Dimensions in mm

CIRCUIT DIAGRAM

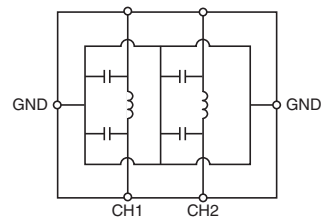

• All specifications are subject to change without notice.

MEA-PH series MEA1210PH Type

ELECTRICAL CHARACTERISTICS

CHARACTERISTICS SPECIFICATION TABLE

Capacitance (pF)	Cutoff frequency (MHz)typ.	Insertion loss 20dB frequency range (MHz)	Rated voltage (V)max.	Rated current (mA)max.	Part No.
27	390	800 to 3000	6.3	100	MEA1210PH270T□□□
22	410	800 to 3000	6.3	100	MEA1210PH220T□□□
15	430	800 to 3000	6.3	100	MEA1210PH150T□□□

○ Measurement equipment

Measurement item	Product No.	Manufacturer
Capacitance	4294A	Agilent Technologies
Frequency characteristics	N5230C	Agilent Technologies

* Equivalent measurement equipment may be used.

INSERTION LOSS VS. FREQUENCY CHARACTERISTICS

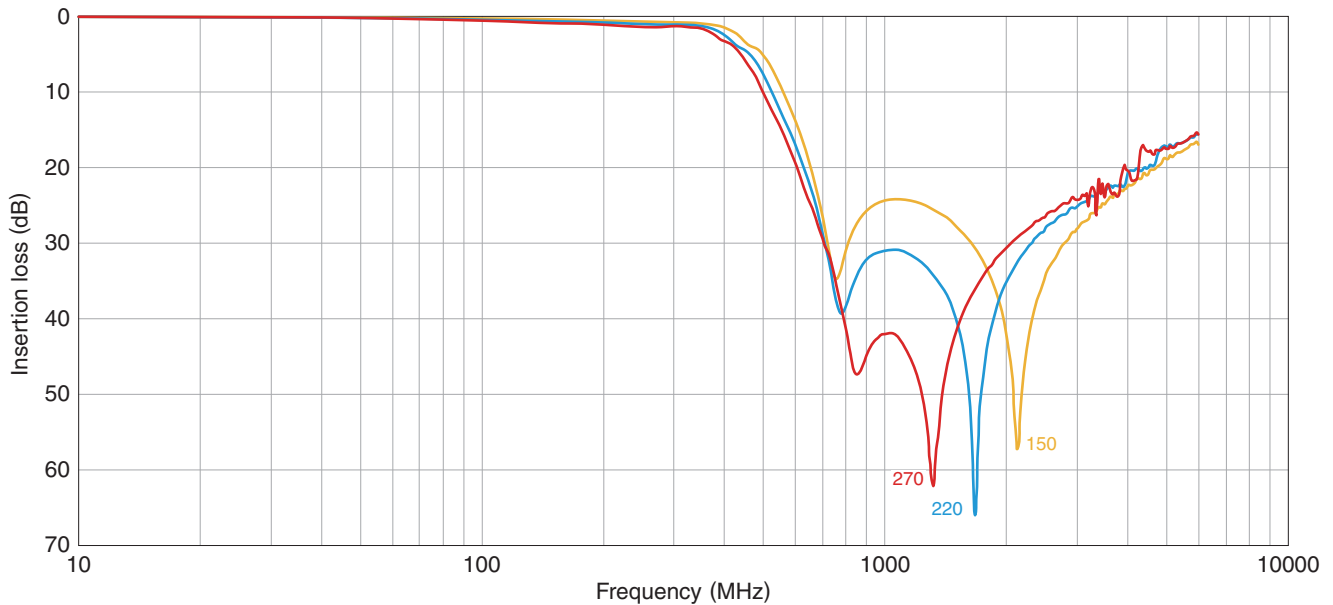

○ Measurement equipment

Product No.	Manufacturer
N5230C	Agilent Technologies

* Equivalent measurement equipment may be used.

• All specifications are subject to change without notice.

MEA-PH series

MEA1608PH Type



SHAPE & DIMENSIONS

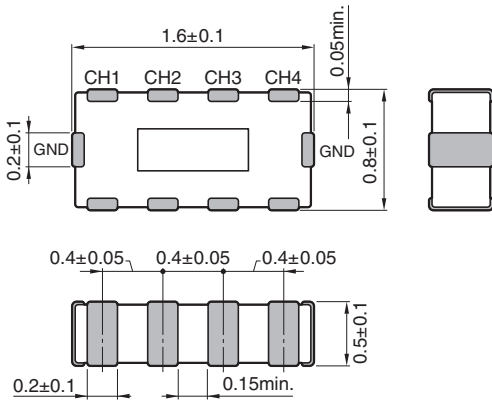

RECOMMENDED LAND PATTERN

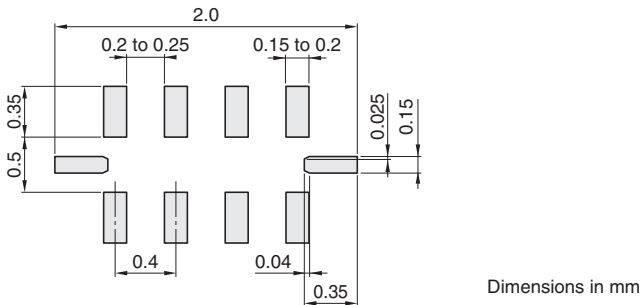

CIRCUIT DIAGRAM

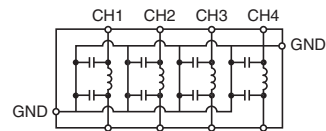

• All specifications are subject to change without notice.

MEA-PH series MEA1608PH Type

ELECTRICAL CHARACTERISTICS

CHARACTERISTICS SPECIFICATION TABLE

Capacitance (pF)	Cutoff frequency (MHz)typ.	Insertion loss 20dB frequency range (MHz)	Rated voltage (V)max.	Rated current (mA)max.	Part No.
27	410	800 to 3000	6.3	100	MEA1608PH270T□□□
22	420	800 to 3000	6.3	100	MEA1608PH220T□□□
15	480	800 to 3000	6.3	100	MEA1608PH150T□□□

Measurement equipment

Measurement item	Product No.	Manufacturer
Capacitance	4294A	Agilent Technologies
Frequency characteristics	N5230C	Agilent Technologies

* Equivalent measurement equipment may be used.

INSERTION LOSS VS. FREQUENCY CHARACTERISTICS

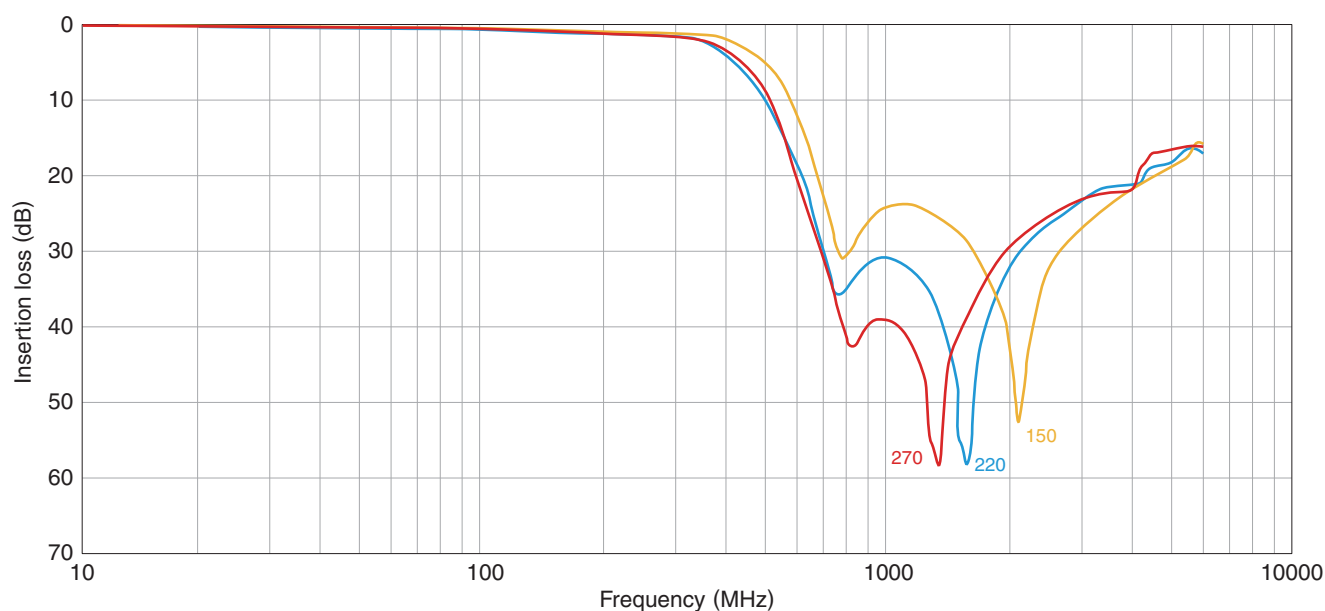

Measurement equipment

Product No.	Manufacturer
N5230C	Agilent Technologies

* Equivalent measurement equipment may be used.

• All specifications are subject to change without notice.

MEA-D/-PH series

Packaging style

REEL DIMENSIONS

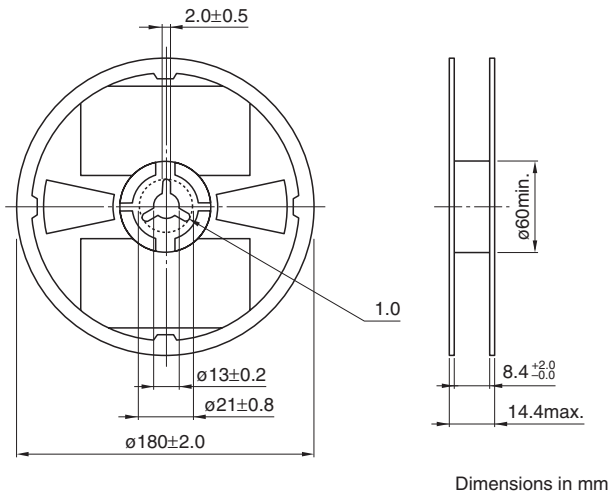

TAPE DIMENSIONS

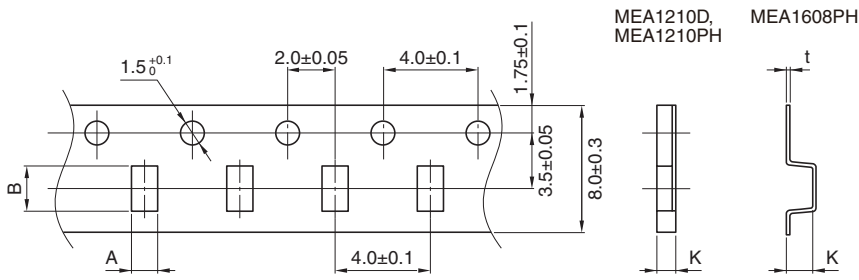

Type	A	B	K	t
ME A1210D	1.20±0.05	1.45±0.05	0.73max.	—
ME A1210PH	1.20±0.05	1.45±0.05	0.73max.	—
ME A1608PH	1.00±0.10	1.80±0.10	1.0max.	0.25±0.05

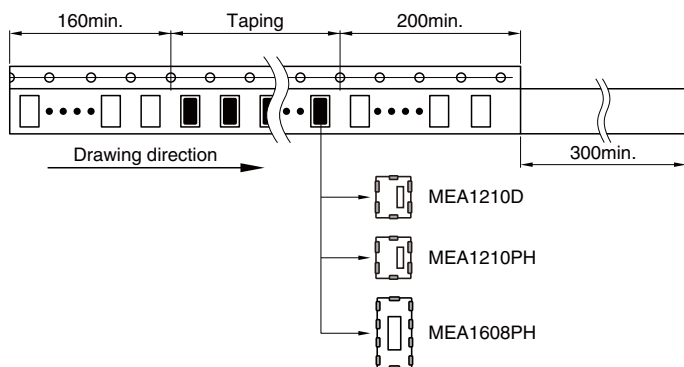

• All specifications are subject to change without notice.