

## GaAs PHEMT MMIC LOW NOISE AMPLIFIER, 6 - 20 GHz

### Typical Applications

The HMC565 is ideal for use as a LNA or driver amplifier for:

- Point-to-Point Radios
- Point-to-Multi-Point Radios & VSAT
- Test Equipment and Sensors
- Military & Space

### Features

- Noise Figure: 2.3 dB
- Gain: 22 dB
- OIP3: 20 dBm
- Single Supply: +3V @ 53 mA
- 50 Ohm Matched Input/Output
- Small size: 2.53 x 0.98 x 0.10 mm

### Functional Diagram

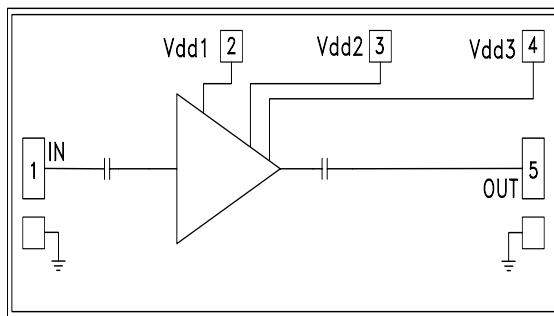

### General Description

The HMC565 is a high dynamic range GaAs PHEMT MMIC Low Noise Amplifier (LNA) chip which operates from 6 to 20 GHz. The HMC565 features 22 dB of small signal gain, 2.3 dB of noise figure and has a consistent IP3 of 20 dBm across the operating band. This self-biased LNA is ideal for hybrid and MCM assemblies due to its compact size, wideband performance, single +3V supply operation, and DC blocked RF I/O's. All data is measured with the chip in a 50 Ohm test fixture connected via two 0.025 mm (1 mil) diameter bondwires of minimal length 0.31 mm (12 mil).

### Electrical Specifications, $T_A = +25^\circ\text{C}$ , Vdd 1, 2, 3 = +3V

Parameter	Min.	Typ.	Max.	Min.	Typ.	Max.	Units
Frequency Range	6 - 12		12 - 20				GHz
Gain	20	23		17	21		dB
Gain Variation Over Temperature		0.025	0.035		0.025	0.035	dB/°C
Noise Figure		2.3	2.8		2.5	3.0	dB
Input Return Loss		15			12		dB
Output Return Loss		15			10		dB
Output Power for 1 dB Compression (P1dB)	7	10		7	10		dBm
Saturated Output Power (Psat)		12			12		dBm
Output Third Order Intercept (IP3)	17	20		17	20		dBm
Supply Current (Idd)(Vdd = +3V)		53			53		mA

Information furnished by Analog Devices is believed to be accurate and reliable. However, no responsibility is assumed by Analog Devices for its use, nor for any infringements of patents or other rights of third parties that may result from its use. Specifications subject to change without notice. No license is granted by implication or otherwise under any patent or patent rights of Analog Devices. Trademarks and registered trademarks are the property of their respective owners.

For price, delivery, and to place orders: Analog Devices, Inc., One Technology Way, P.O. Box 9106, Norwood, MA 02062-9106  
 Phone: 781-329-4700 • Order online at [www.analog.com](http://www.analog.com)  
 Application Support: Phone: 1-800-ANALOG-D

**GaAs PHEMT MMIC LOW NOISE AMPLIFIER, 6 - 20 GHz**

**Broadband Gain & Return Loss**

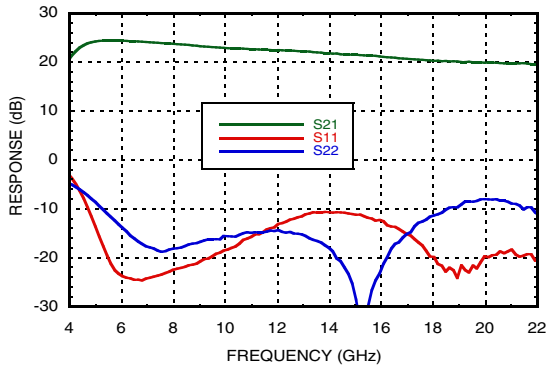

**Gain vs. Temperature**

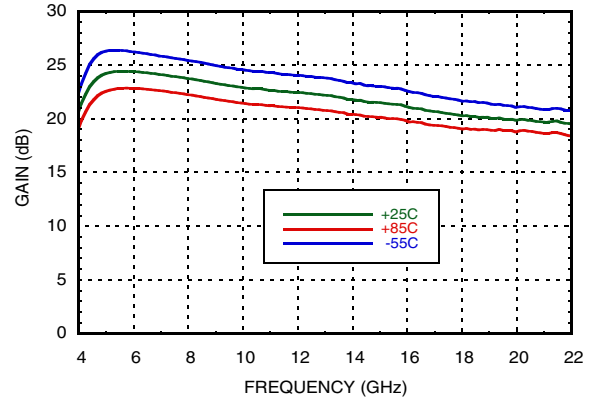

**Input Return Loss vs. Temperature**

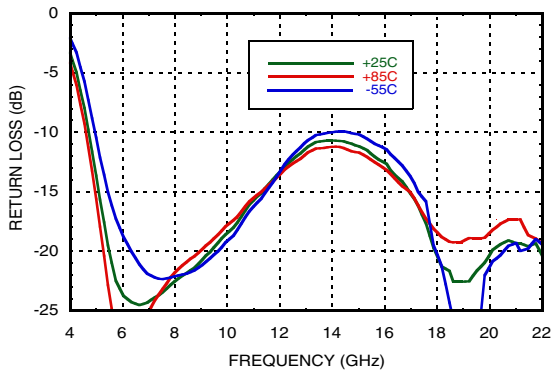

**Output Return Loss vs. Temperature**

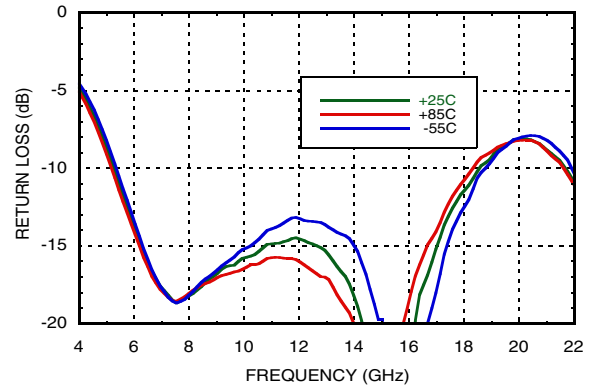

**Noise Figure vs. Temperature**

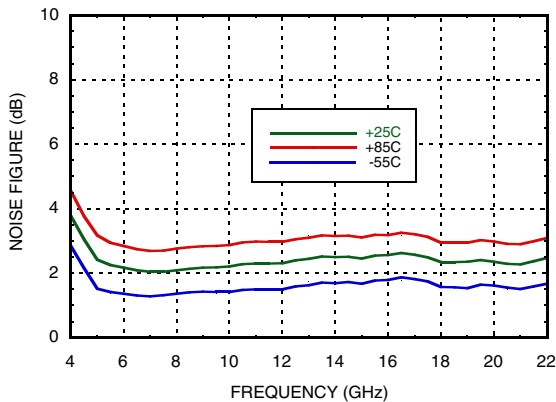

**Reverse Isolation vs. Temperature**

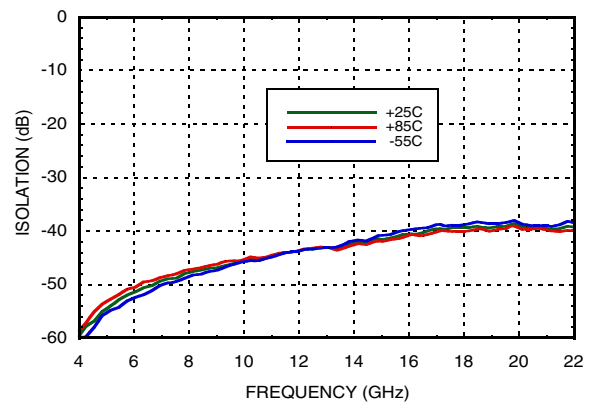

**GaAs PHEMT MMIC LOW NOISE AMPLIFIER, 6 - 20 GHz**

LOW NOISE AMPLIFIERS - CHIP

**P1dB vs. Temperature**

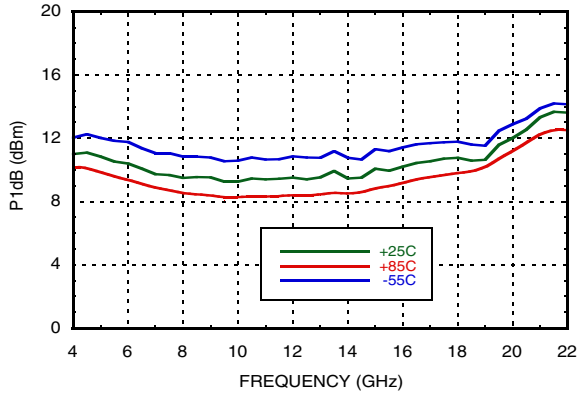

**Psat vs. Temperature**

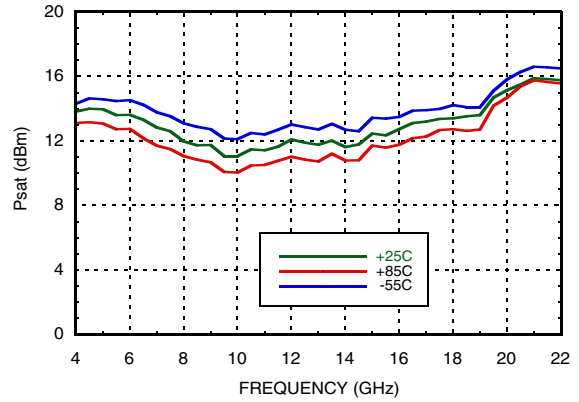

**Output IP3 vs. Temperature**

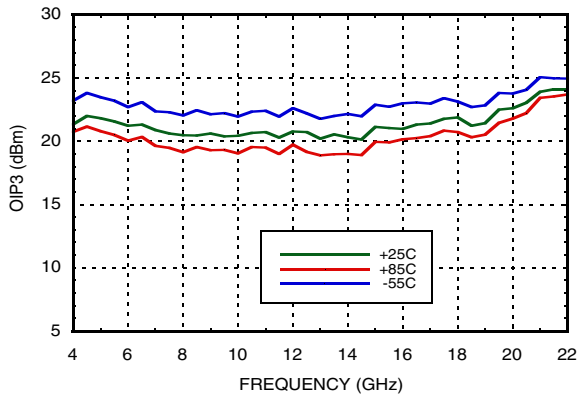

**Power Compression @ 13 GHz**

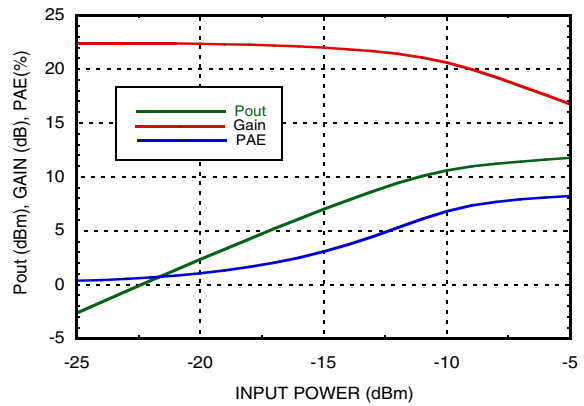

**Gain, Noise Figure & Power vs. Supply Voltage @ 13 GHz**

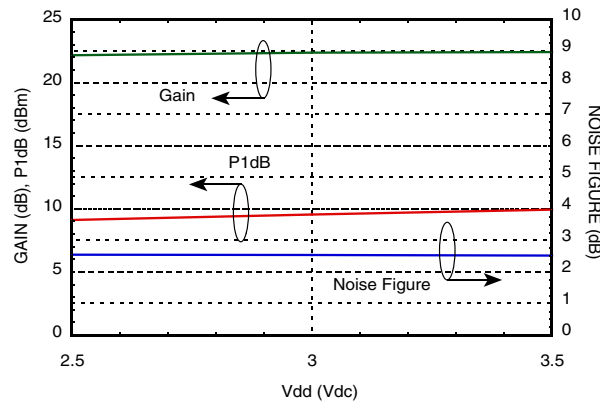

## GaAs PHEMT MMIC LOW NOISE AMPLIFIER, 6 - 20 GHz

### Absolute Maximum Ratings

Drain Bias Voltage (Vdd1, Vdd2, Vdd3)	+3.5 Vdc
RF Input Power (RFIN)(Vdd = +3.0 Vdc)	10 dBm
Channel Temperature	175 °C
Continuous P <sub>diss</sub> (T= 85 °C) (derate 8.9 mW/°C above 85 °C)	0.75 W
Thermal Resistance (channel to die bottom)	119 °C/W
Storage Temperature	-65 to +150 °C
Operating Temperature	-55 to +85 °C
ESD Sensitivity (HBM)	Class 1A

### Typical Supply Current vs. Vdd

Vdd (Vdc)	I <sub>dd</sub> (mA)
+2.5	51
+3.0	53
+3.5	55

Note: Amplifier will operate over full voltage ranges shown above.



ELECTROSTATIC SENSITIVE DEVICE  
OBSERVE HANDLING PRECAUTIONS

### Outline Drawing

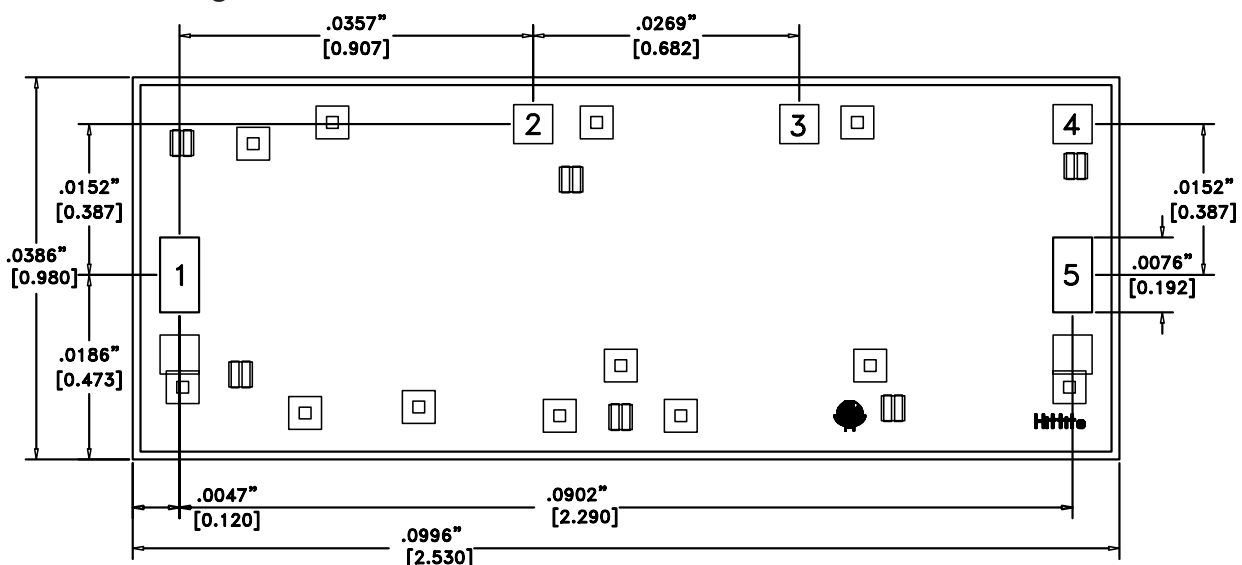

### Die Packaging Information [1]

Standard	Alternate
GP-2 (Gel Pack)	[2]

[1] Refer to the "Packaging Information" section for die packaging dimensions.

[2] For alternate packaging information contact Hittite Microwave Corporation.

#### NOTES:

- ALL DIMENSIONS ARE IN INCHES [MM]
- DIE THICKNESS IS .004"
- TYPICAL BOND IS .004" SQUARE
- BACKSIDE METALLIZATION: GOLD
- BOND PAD METALLIZATION: GOLD
- BACKSIDE METAL IS GROUND.
- CONNECTION NOT REQUIRED FOR UNLABELED BOND PADS.

For price, delivery, and to place orders: Analog Devices, Inc., One Technology Way, P.O. Box 9106, Norwood, MA 02062-9106  
Phone: 781-329-4700 • Order online at [www.analog.com](http://www.analog.com)  
Application Support: Phone: 1-800-ANALOG-D

**GaAs PHEMT MMIC LOW NOISE AMPLIFIER, 6 - 20 GHz**

**Pad Descriptions**

Pad Number	Function	Description	Interface Schematic
1	IN	This pad is AC coupled and matched to 50 Ohms from 6 - 20 GHz.	IN ○ —  —
2, 3, 4	Vdd1, 2, 3	Power Supply Voltage for the amplifier. External bypass capacitors of 100 pF and 0.1 μF are required.	○ Vdd1,2,3 —  —
5	OUT	This pad is AC coupled and matched to 50 Ohms from 6 - 20 GHz.	—  — ○ OUT
Die Bottom	GND	Die Bottom must be connected to RF/DC ground.	○ GND —  —

**Assembly Diagram**

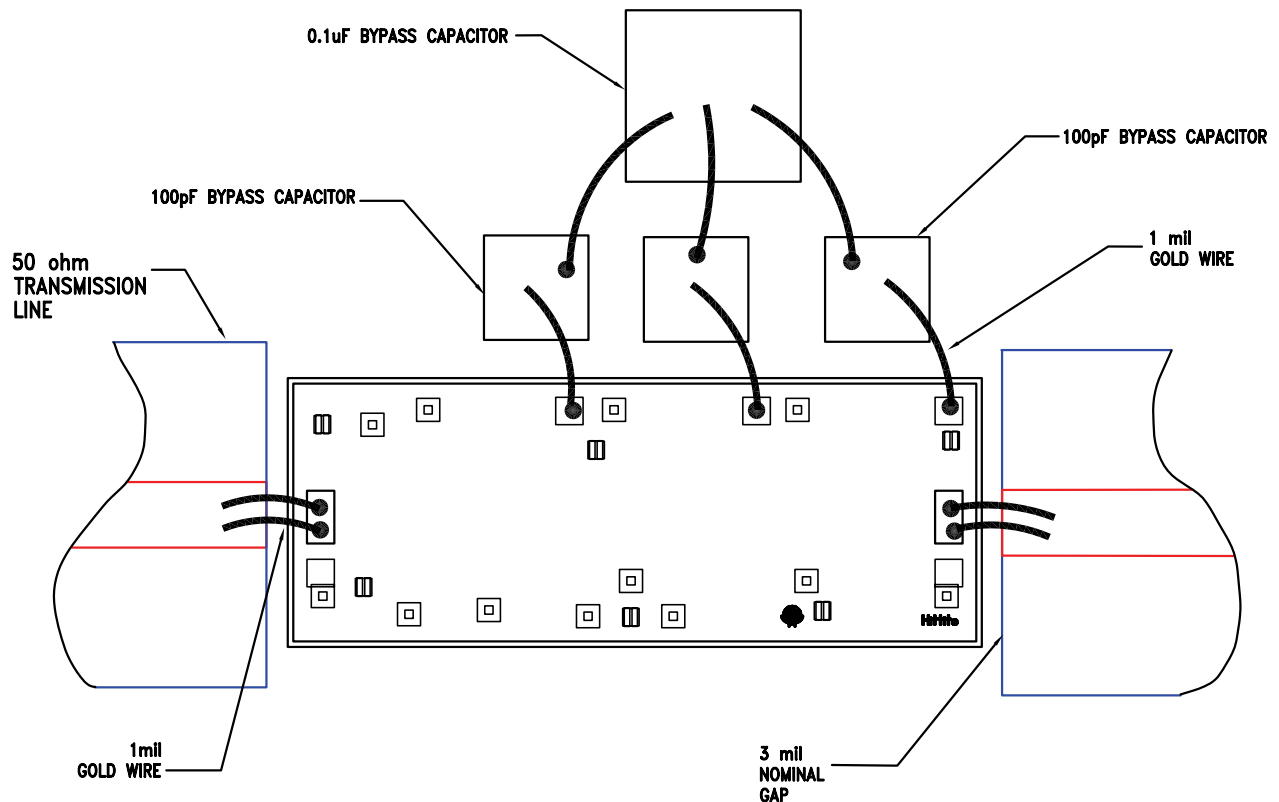

For price, delivery, and to place orders: Analog Devices, Inc., One Technology Way, P.O. Box 9106, Norwood, MA 02062-9106  
 Phone: 781-329-4700 • Order online at [www.analog.com](http://www.analog.com)  
 Application Support: Phone: 1-800-ANALOG-D

## GaAs PHEMT MMIC LOW NOISE AMPLIFIER, 6 - 20 GHz

### Mounting & Bonding Techniques for Millimeterwave GaAs MMICs

The die should be attached directly to the ground plane eutectically or with conductive epoxy (see HMC general Handling, Mounting, Bonding Note).

50 Ohm Microstrip transmission lines on 0.127mm (5 mil) thick alumina thin film substrates are recommended for bringing RF to and from the chip (Figure 1). If 0.254mm (10 mil) thick alumina thin film substrates must be used, the die should be raised 0.150mm (6 mils) so that the surface of the die is coplanar with the surface of the substrate. One way to accomplish this is to attach the 0.102mm (4 mil) thick die to a 0.150mm (6 mil) thick molybdenum heat spreader (moly-tab) which is then attached to the ground plane (Figure 2).

Microstrip substrates should be brought as close to the die as possible in order to minimize bond wire length. Typical die-to-substrate spacing is 0.076mm (3 mils).

#### Handling Precautions

Follow these precautions to avoid permanent damage.

**Storage:** All bare die are placed in either Waffle or Gel based ESD protective containers, and then sealed in an ESD protective bag for shipment. Once the sealed ESD protective bag has been opened, all die should be stored in a dry nitrogen environment.

**Cleanliness:** Handle the chips in a clean environment. DO NOT attempt to clean the chip using liquid cleaning systems.

**Static Sensitivity:** Follow ESD precautions to protect against  $> \pm 250V$  ESD strikes.

**Transients:** Suppress instrument and bias supply transients while bias is applied. Use shielded signal and bias cables to minimize inductive pick-up.

**General Handling:** Handle the chip along the edges with a vacuum collet or with a sharp pair of bent tweezers. The surface of the chip has fragile air bridges and should not be touched with vacuum collet, tweezers, or fingers.

#### Mounting

The chip is back-metallized and can be die mounted with AuSn eutectic preforms or with electrically conductive epoxy. The mounting surface should be clean and flat.

**Eutectic Die Attach:** A 80/20 gold tin preform is recommended with a work surface temperature of 255 °C and a tool temperature of 265 °C. When hot 90/10 nitrogen/hydrogen gas is applied, tool tip temperature should be 290 °C. DO NOT expose the chip to a temperature greater than 320 °C for more than 20 seconds. No more than 3 seconds of scrubbing should be required for attachment.

**Epoxy Die Attach:** Apply a minimum amount of epoxy to the mounting surface so that a thin epoxy fillet is observed around the perimeter of the chip once it is placed into position. Cure epoxy per the manufacturer's schedule.

#### Wire Bonding

Ball or wedge bond with 0.025 mm (1 mil) diameter pure gold wire is recommended. Thermosonic wirebonding with a nominal stage temperature of 150 °C and a ball bonding force of 40 to 50 grams or wedge bonding force of 18 to 22 grams is recommended. Use the minimum level of ultrasonic energy to achieve reliable wirebonds. Wirebonds should be started on the chip and terminated on the package or substrate. All bonds should be as short as possible  $< 0.31$  mm (12 mils).

