

LTM4631

Ultrathin Dual 10A or Single 20A DC/DC μ Module Regulator

DESCRIPTION

Demonstration circuit 2147A features the **LTM[®]4631**, the high efficiency, high density, dual 10A, switch mode step-down μ Module[®] power module regulator. The input voltage is from 4.5V to 15V. The output voltage is programmable from 0.6V to 1.8V. DC2147A can deliver up to 10A maximum in each channel. As explained in the data sheet, output current derating is necessary for certain V_{IN} , V_{OUT} , and thermal conditions. The board operates in continuous conduction mode in heavy load conditions. For high efficiency at low load currents, the MODE jumper (JP1) selects pulse-skipping mode for noise sensitive applications or Burst Mode[®] operation in less noise sensitive applications. Two outputs can be connected in parallel for a single 20A output solution with optional jumper resistors. The board allows the user to program how its output

ramps up and down through the TRACK/SS pin. The output can be set up to either coincidentally or ratio-metrically track with another supply's output. Remote output voltage sensing is available for improved output voltage regulation at the load point. These features and the availability of the LTM4631 in a compact 16mm \times 16mm \times 1.91mm LGA package make it ideal for use in many high density point-of-load regulation applications. The LTM4631 data sheet must be read in conjunction with this demo manual for working on or modifying the demo circuit DC2147A.

Design files for this circuit board are available at <http://www.linear.com/demo/DC2147A>

LT, LT, LTC, LTM, Linear Technology, Burst Mode, μ Module and the Linear logo are registered trademarks of Linear Technology Corporation. All other trademarks are the property of their respective owners.

BOARD PHOTO

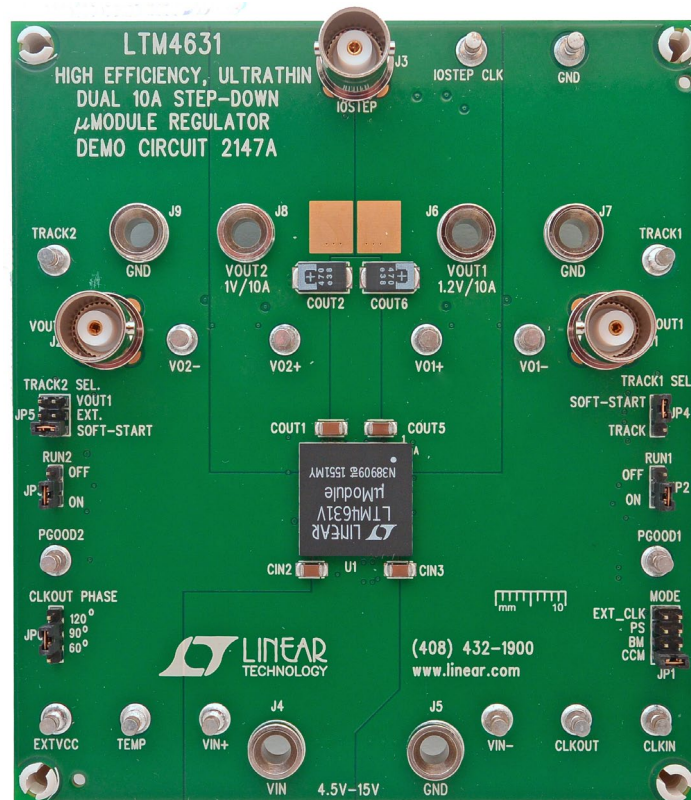

dc2147af

DEMO MANUAL DC2147A

PERFORMANCE SUMMARY Specifications are at $T_A = 25^\circ\text{C}$

PARAMETER	CONDITIONS/NOTES	VALUE
Input Voltage Range		4.5V ~ 15V
Output Voltage V_{OUT1}	$V_{IN} = 4.5\text{V} \sim 15\text{V}$, $I_{OUT1} = 0\text{A} \sim 10\text{A}$, JP1: CCM	$1.2\text{V} \pm 1.5\%$ (1.182V ~ 1.218V)
Output Voltage V_{OUT2}	$V_{IN} = 4.5\text{V} \sim 15\text{V}$, $I_{OUT2} = 0\text{A} \sim 10\text{A}$, JP1: CCM	$1\text{V} \pm 1.5\%$ (0.985V ~ 1.015V)
Per-Channel Maximum Continuous Output Current	Derating Is Necessary for Certain V_{IN} , V_{OUT} and Thermal Conditions, See Data Sheet for Detail.	10A
Default Operating Frequency		650kHz
Resistor Programmable Frequency Range		250kHz to 780kHz
External Clock Sync Frequency Range		400kHz to 780kHz
Efficiency of Channel 1	$V_{IN} = 12\text{V}$, $V_{OUT1} = 1.2\text{V}$, $I_{OUT1} = 10\text{A}$, $f_{SW} = 650\text{kHz}$	81.5% See Figure 2
Efficiency of Channel 2	$V_{IN} = 12\text{V}$, $V_{OUT2} = 1\text{V}$, $I_{OUT2} = 10\text{A}$, $f_{SW} = 650\text{kHz}$	78.7% See Figure 3
Load Transient of Channel 1	$V_{IN} = 12\text{V}$, $V_{OUT1} = 1.2\text{V}$, $I_{STEP} = 5\text{A} \sim 10\text{A}$	See Figure 4
Load Transient of Channel 2	$V_{IN} = 12\text{V}$, $V_{OUT2} = 1\text{V}$, $I_{STEP} = 5\text{A} \sim 10\text{A}$	See Figure 5

QUICK START PROCEDURE

Demonstration circuit 2147A is easy to set up to evaluate the performance of the LTM4631EV. Please refer to Figure 1 for proper measurement setup and follow the procedure below:

1. Place jumpers in the following positions for a typical application:

JP1	JP2	JP3	JP4	JP5	JP6
MODE	RUN1	RUN2	TRACK1 SELECT	TRACK2 SELECT	CLKOUT PHASE
CCM	ON	ON	SOFT-START	SOFT-START	90°

2. With power off, connect the input power supply, load and meters as shown in Figure 1. Preset the load to 0A and V_{IN} supply to 12V.

3. Turn on the power supply at the input. The output voltage in channel 1 should be $1.2\text{V} \pm 1.5\%$ (1.182V ~ 1.218V) and the output voltage in channel 2 should be $1\text{V} \pm 1.5\%$ (0.985V ~ 1.015V).

4. Once the proper output voltage is established, adjust the load within the operating range and observe the output voltage regulation, output voltage ripple, efficiency and other parameters. Output ripple should be measured at J1 and J2 with BNC cables. 50 Ω termination should be set on the oscilloscope or BNC cables.

QUICK START PROCEDURE

- (Optional) For optional load transient test, apply an adjustable pulse signal between IOSTEP CLK and GND test point. Pulse amplitude sets the load step current amplitude. The output transient current can be monitored at the BNC connector J3 (50mV/A). The pulse signal should have very small duty cycle (< 10%) to limit the thermal stress on the transient load circuit. Switch the jumper resistors R34 or R35 (on the backside of boards) to apply load transient on channel 1 or channel 2 correspondingly.
- (Optional) LTM4631 can be synchronized to an external clock signal. Place the JP1 jumper on EXT_CLK and apply a clock signal (0V ~ 5V, square wave) on the CLKIN test point.
- (Optional) The outputs of LTM4631 can track another supply. The jumpers JP4 and JP5 allow choosing soft-start or output tracking. If tracking external voltage is selected, the corresponding test points, TRACK1 and TRACK2, need to be connected to a valid voltage signal.
- (Optional) LTM4631 can be configured for a 2-phase single output at up to 20A on DC2147A. Install 0Ω resistors on R₁₄, R₁₇, R₂₈, R₃₉ and remove R₇, R₁₉. Output voltage is set by R₂₅ based on equation $V_{OUT} = 0.6V(1+60.4K/R_{25})$.

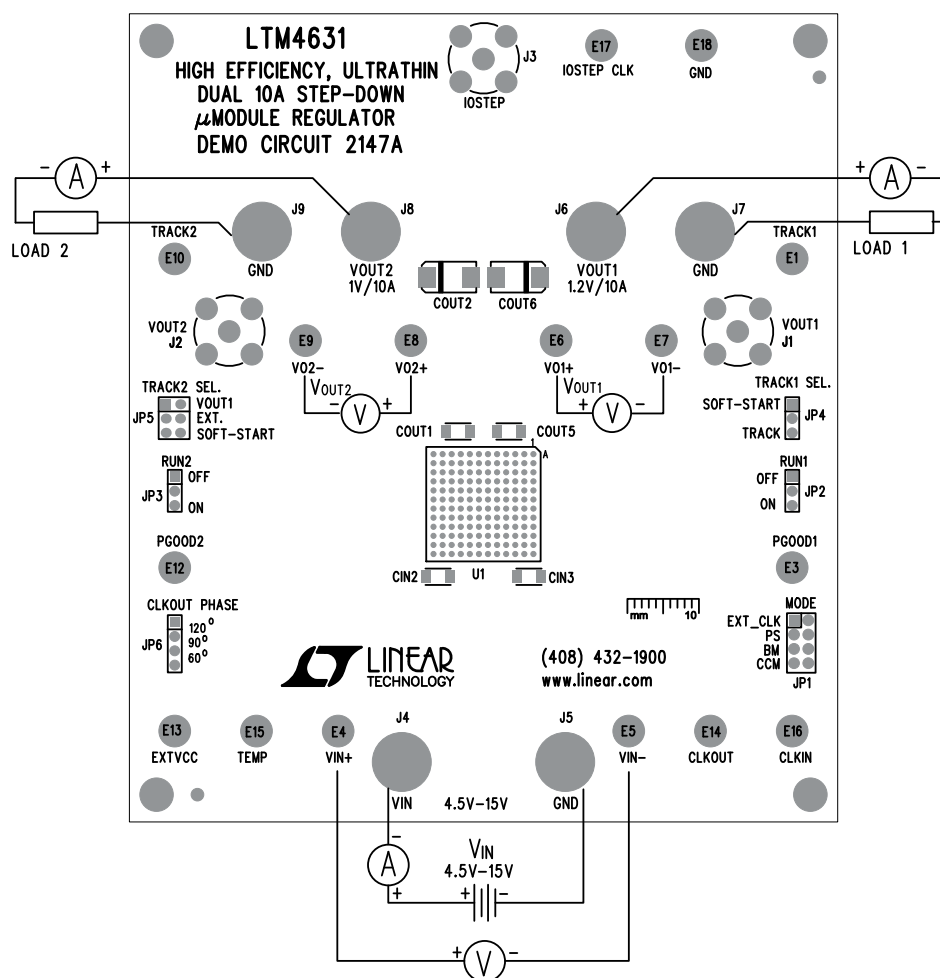

Figure 1. Test Setup of DC2147A

QUICK START PROCEDURE

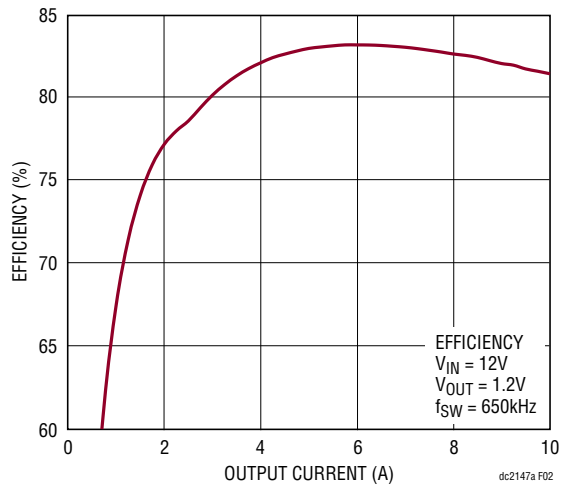

Figure 2. Measured Efficiency on Channel 1
($V_{OUT1} = 1.2V$, $f_{SW} = 650kHz$, Channel 2 Disabled)

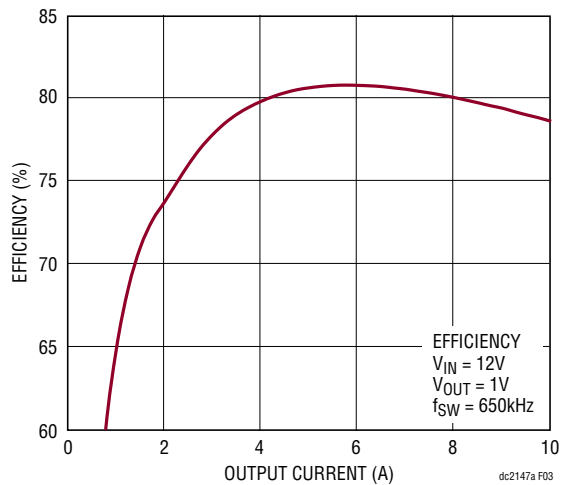

Figure 3. Measured Efficiency on Channel 2
($V_{OUT2} = 1V$, $f_{SW} = 650kHz$, Channel 1 Disabled)

QUICK START PROCEDURE

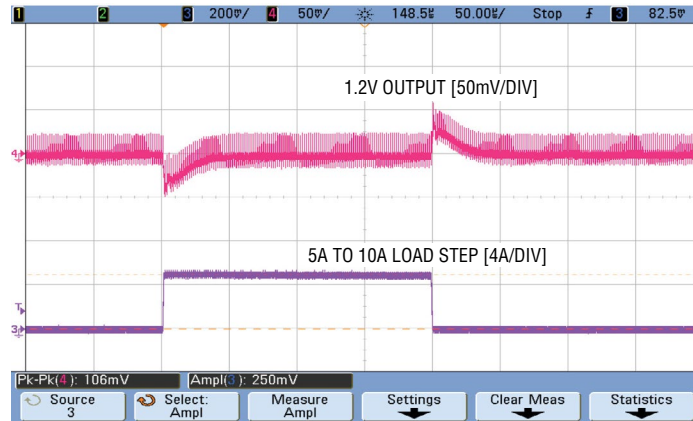

Figure 4. Measured Channel 1 5A to 10A Load Transient
 ($V_{IN} = 12V, V_{OUT1} = 1.2V$)

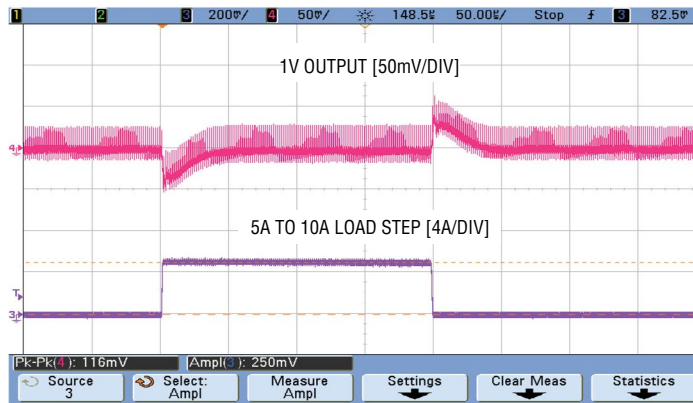

Figure 5. Measured Channel 2 5A to 10A Load Transient
 ($V_{IN} = 12V, V_{OUT2} = 1V$)

QUICK START PROCEDURE

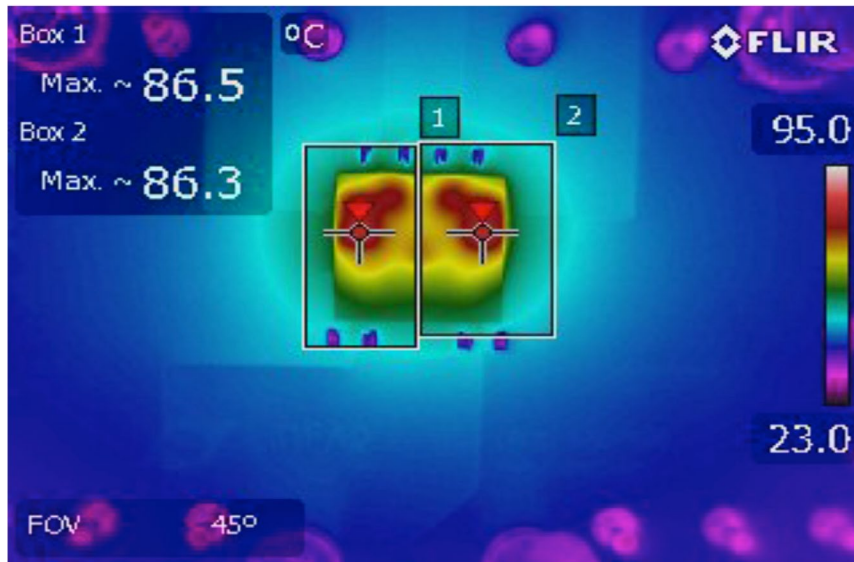

Figure 6. Thermal Capture at 12V_{IN}, 1.2V_{OUT1} at 10A and 1V_{OUT2} at 10A (T_A = 25°C, No Forced Airflow and No Heat Sink)

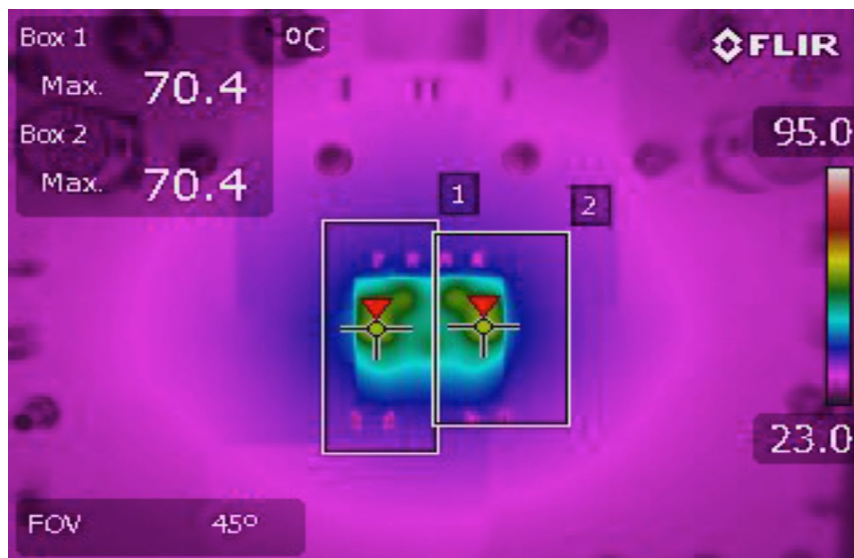

Figure 7. Thermal Capture at 12V_{IN}, 1.2V_{OUT1} at 10A and 1V_{OUT2} at 10A (T_A = 25°C, 200LFM Airflow and No Heat Sink)

PARTS LIST

ITEM	QTY	REFERENCE	PART DESCRIPTION	MANUFACTURER/PART NUMBER
Required Circuit Components				
1	1	CIN1	CAP, 150µF, 25V, ALUMINUM ELECTR	SUN ELECT, 25CE150AX
2	2	CIN2, CIN3	CAP, X5R, 22µF, 25V, 20%, 1206	TDK, C3216X5R1E226M160AB
3	2	COU1, COU5	CAP, X5R, 100µF, 4V, 20%, 1206	TDK, C3216X5R0G107M160AB
4	2	COU2, COU6	CAP, 470µF, 2.5V, POSCAP, F8, 7343	SANYO, 2R5TPE470M9
5	1	C2	CAP, X7R, 1µF, 25V, 10%, 0805	AVX, 08053C105KAT2A
6	2	C5, C7	CAP, X5R, 0.1µF, 25V, 10%, 0603	AVX, 06033D104KAT2A
7	2	C13, C14	CAP, X7R, 0.01µF, 50V, 10%, 0603	AVX, 06035C103KAT2A
8	2	C15, C16	CAP, X7R, 1µF, 10V, 10%, 0603	AVX, 06033C105KAT2A
9	1	Q1	XSTR, SUD50N04-8M8P-4GE3, MOSFET, TO252	VISHAY, SUD50N04-8M8P-4GE3
10	4	R1, R3, R22, R26	RES, 10, 1%, 0603	VISHAY, CRCW060310R0FKEA
11	1	R5	RES, 121k, 1%, 0603	VISHAY, CRCW0603121KFKEA
12	5	R9, R12, R15, R18, R25	RES, 60.4k, 1%, 0603	VISHAY, CRCW060360K4FKEA
13	2	R10, R13	RES, 6.04k, 1%, 0603	VISHAY, CRCW06036K04FKEA
14	1	R19	RES, 90.9k, 1%, 0603	VISHAY, CRCW060390K9FKEA
15	3	R24, R27, R36	RES, 10k, 1%, 0603	VISHAY, CRCW060310K0FKEA
16	1	R30	RES, 154k, 1%, 0603	VISHAY, CRCW0603154KFKEA
17	1	R37	RES, 0.05Ω, 1W, 2512	VISHAY, WSL2512R0050FEA
18	1	U1	LTM4631EV#PBF, 16X16X4.41-LGA	LINEAR TECHNOLOGY, LTM4631EV#PBF
Additional Demo Board Circuit Components				
1	0	COU3, COU7	OPT, 1206	OPT
2	0	COU4, COU8	OPT, 7343	OPT
3	0	C1	OPT, 0805	OPT
4	0	C3, C4, C6, C8 TO C12, C17, C18	OPT, 0603	OPT
5	0	R2, R4, R6, R8, R11, R14, R16, R17, R20, R23, R28, R31, R33, R39, R40, R41, R42	OPT, 0603	OPT
6	4	R7, R21, R29, R32	RES, 0, 1%, 0603	VISHAY, CRCW06030000Z0EA
7	1	R34	RES, 0Ω, 0.5W, 2010	VISHAY, CRCW20100000Z0EF
8	0	R35	OPT, 2010	OPT
9	0	R38	OPT, 2512	OPT
Hardware: For Demo Board Only				
1	16	E1, E3 TO E10, E12 TO E18	TESTPOINT, TURRET, 0.094"	MILL-MAX, 2501-2-00-80-00-00-07-0
2	1	JP1	HEADER, 2X4 0.079 DOUBLE ROW	SULLINS, NRPN042PAEN-RC
3	3	JP2, JP3, JP4	HEADER, 1X3 0.079 SINGLE ROW	SULLINS, NRPN031PAEN-RC
4	1	JP5	HEADER, 2X3 0.079 DOUBLE ROW	SULLINS, NRPN032PAEN-RC
5	1	JP6	HEADER, 1X4 0.079 SINGLE ROW	SULLINS, NRPN041PAEN-RC
6	6	XJP1 TO XJP6	SHUNT, 0.079" CENTER	SAMTEC, 2SN-BK-G
7	3	J1, J2, J3	CONN, BNC, 5 PINS	CONNEX 112404
8	6	J4 TO J9	JACK BANANA	KEYSTONE, 575-4
9	4	(STAND-OFF)	STAND-OFF, NYLON 0.50"	KEYSTONE, 8833(SNAP ON)

DEMO MANUAL DC2147A

SCHEMATIC DIAGRAM

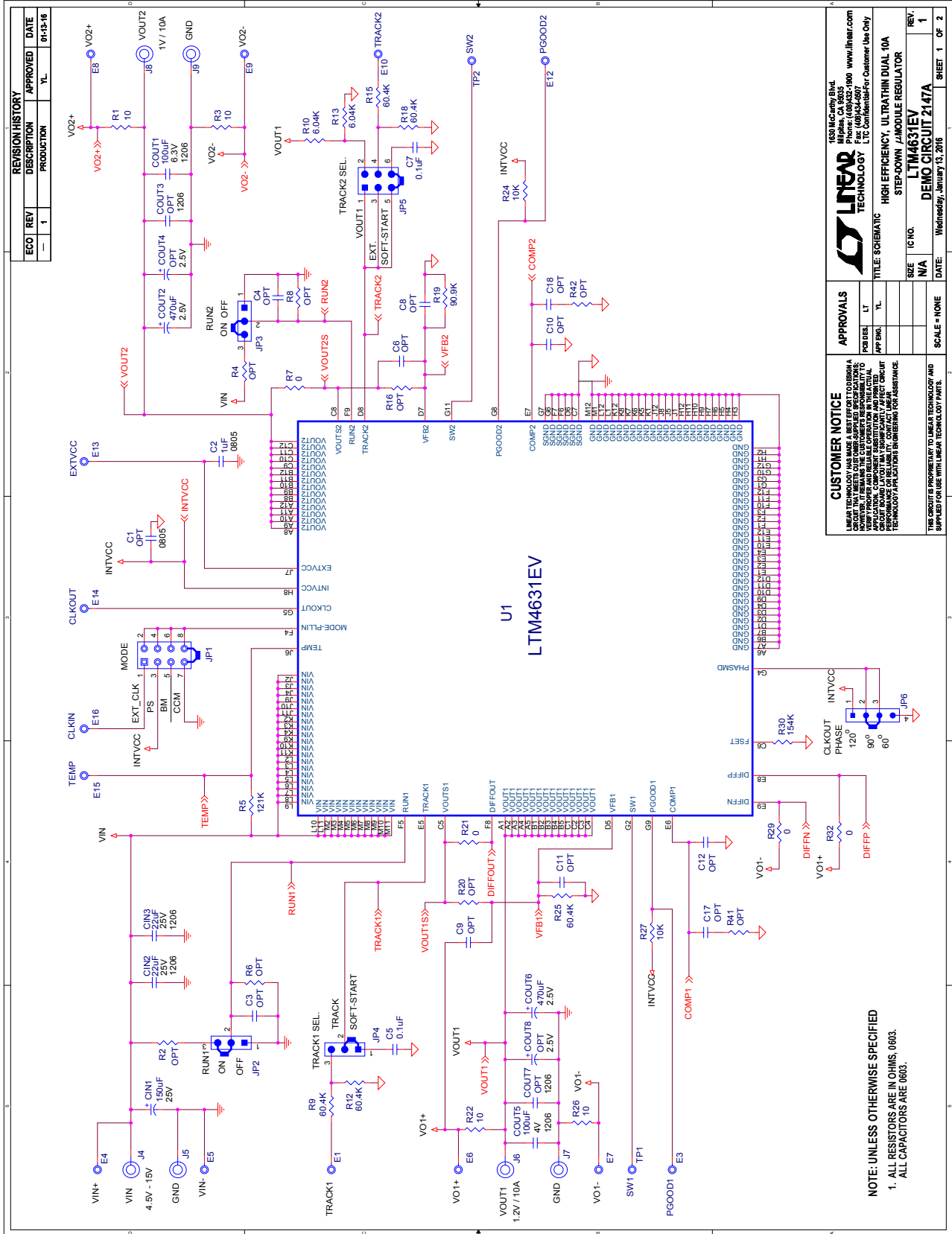

dc2147af

SCHEMATIC DIAGRAM

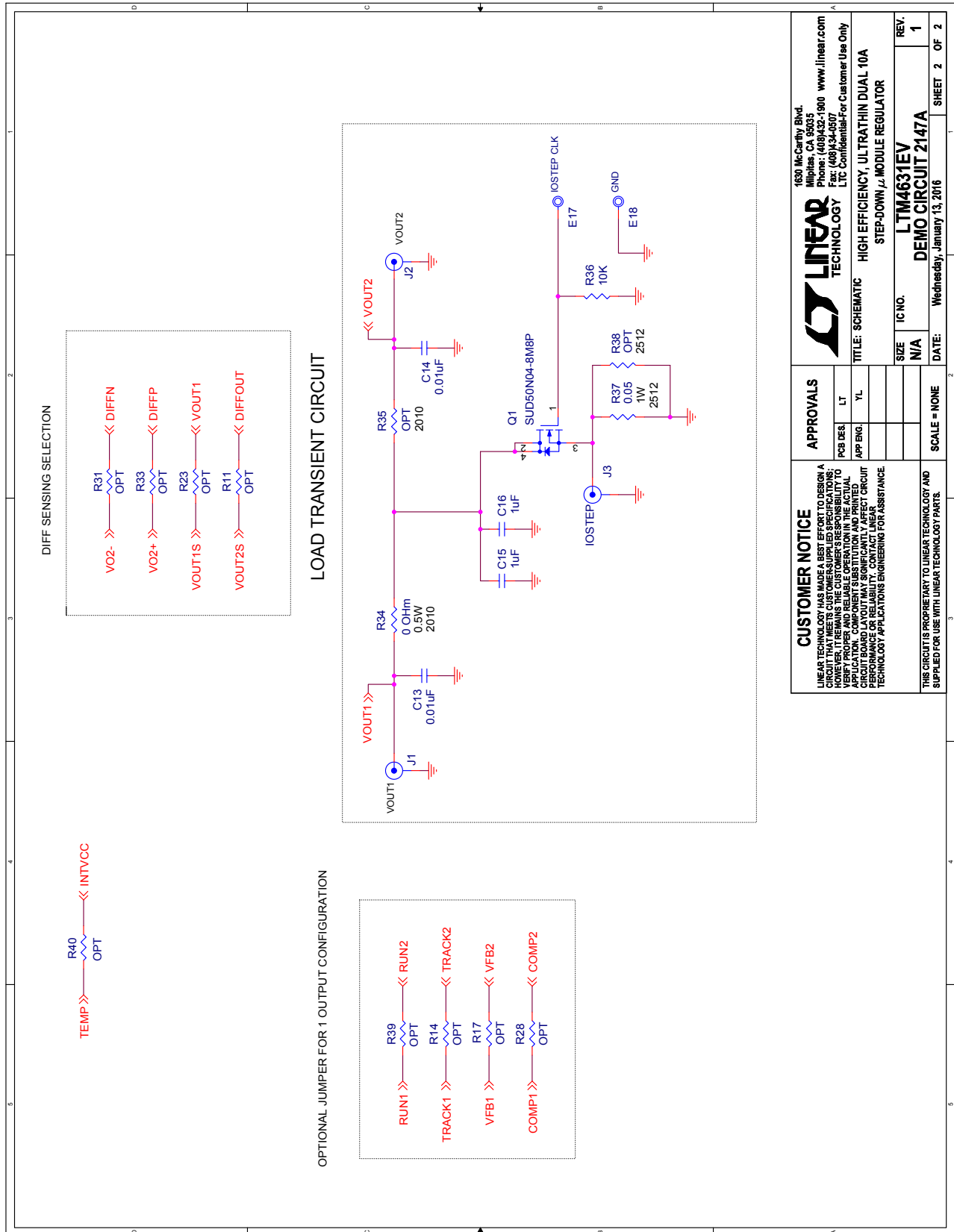

<p>CUSTOMER NOTICE</p> <p>LINEAR TECHNOLOGY HAS MADE A BEST EFFORT TO DESIGN A CIRCUIT THAT MEETS CUSTOMER SUPPLIED SPECIFICATIONS. CUSTOMER AGREES TO HOLD LINEAR TECHNOLOGY HARMLESS FOR ANY DAMAGE TO PROPERTY OR PERSONS ARISING FROM THE USE OF THIS APPLICATION. COMPONENT SUBSTITUTION AND PRINTED CIRCUIT BOARD MANUFACTURING VARIATIONS MAY AFFECT CIRCUIT PERFORMANCE OR RELIABILITY. CONTACT LINEAR TECHNOLOGY APPLICATIONS ENGINEERING FOR ASSISTANCE.</p>		<p>APPROVALS</p>	
		<p>PCB DES. LT</p> <p>APP. ENG. YL</p>	<p>SCALE = NONE</p>
<p>LINEAR TECHNOLOGY 1630 McCarthy Blvd. Milpitas, CA 95035 Phone: (408)432-1900 www.linear.com Fax: (408)434-0507 LTC Confidential-For Customer Use Only</p>		<p>TITLE: SCHEMATIC HIGH EFFICIENCY, ULTRATHIN DUAL 10A STEP-DOWN μ MODULE REGULATOR</p>	
<p>SIZE N/A</p>	<p>IC NO. LTM4631EV</p>	<p>REV. 1</p>	<p>SHEET 2 OF 2</p>
<p>THIS CIRCUIT IS PROPRIETARY TO LINEAR TECHNOLOGY AND SUPPLIED FOR USE WITH LINEAR TECHNOLOGY PARTS.</p>		<p>DATE: Wednesday, January 13, 2016</p>	<p>DEMO CIRCUIT 2147A</p>

DEMO MANUAL DC2147A

DEMONSTRATION BOARD IMPORTANT NOTICE

Linear Technology Corporation (LTC) provides the enclosed product(s) under the following **AS IS** conditions:

This demonstration board (DEMO BOARD) kit being sold or provided by Linear Technology is intended for use for **ENGINEERING DEVELOPMENT OR EVALUATION PURPOSES ONLY** and is not provided by LTC for commercial use. As such, the DEMO BOARD herein may not be complete in terms of required design-, marketing-, and/or manufacturing-related protective considerations, including but not limited to product safety measures typically found in finished commercial goods. As a prototype, this product does not fall within the scope of the European Union directive on electromagnetic compatibility and therefore may or may not meet the technical requirements of the directive, or other regulations.

If this evaluation kit does not meet the specifications recited in the DEMO BOARD manual the kit may be returned within 30 days from the date of delivery for a full refund. **THE FOREGOING WARRANTY IS THE EXCLUSIVE WARRANTY MADE BY THE SELLER TO BUYER AND IS IN LIEU OF ALL OTHER WARRANTIES, EXPRESSED, IMPLIED, OR STATUTORY, INCLUDING ANY WARRANTY OF MERCHANTABILITY OR FITNESS FOR ANY PARTICULAR PURPOSE. EXCEPT TO THE EXTENT OF THIS INDEMNITY, NEITHER PARTY SHALL BE LIABLE TO THE OTHER FOR ANY INDIRECT, SPECIAL, INCIDENTAL, OR CONSEQUENTIAL DAMAGES.**

The user assumes all responsibility and liability for proper and safe handling of the goods. Further, the user releases LTC from all claims arising from the handling or use of the goods. Due to the open construction of the product, it is the user's responsibility to take any and all appropriate precautions with regard to electrostatic discharge. Also be aware that the products herein may not be regulatory compliant or agency certified (FCC, UL, CE, etc.).

No License is granted under any patent right or other intellectual property whatsoever. **LTC assumes no liability for applications assistance, customer product design, software performance, or infringement of patents or any other intellectual property rights of any kind.**

LTC currently services a variety of customers for products around the world, and therefore this transaction **is not exclusive**.

Please read the DEMO BOARD manual prior to handling the product. Persons handling this product must have electronics training and observe good laboratory practice standards. **Common sense is encouraged.**

This notice contains important safety information about temperatures and voltages. For further safety concerns, please contact a LTC application engineer.

Mailing Address:

Linear Technology
1630 McCarthy Blvd.
Milpitas, CA 95035

Copyright © 2004, Linear Technology Corporation